

Data Sheet | Item Number: 2200-1201

2-conductor through terminal block; with push-button; 1 mm²; with test port; side and center marking; for DIN-rail 35 x 15 and 35 x 7.5; Push-in CAGE CLAMP®; 1,00 mm²; gray

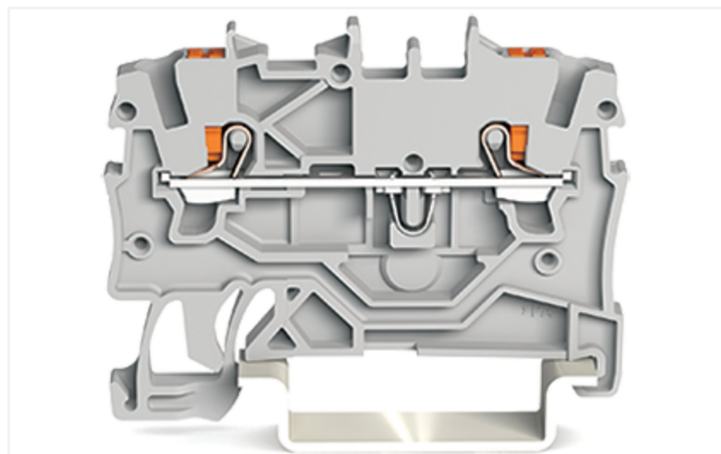

<https://www.wago.com/2200-1201>

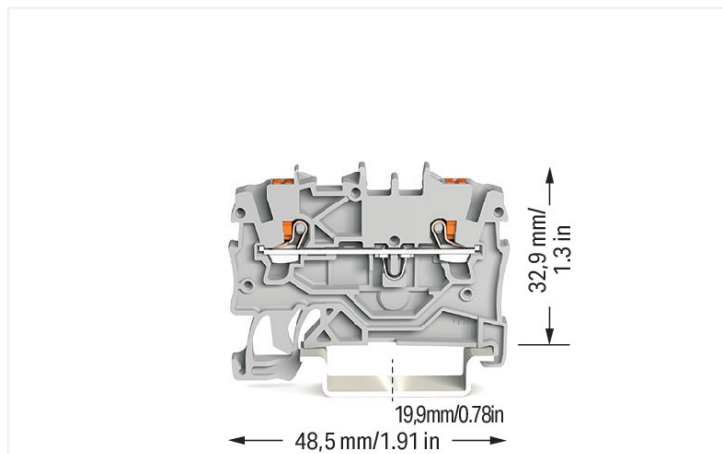

Color: ■ gray

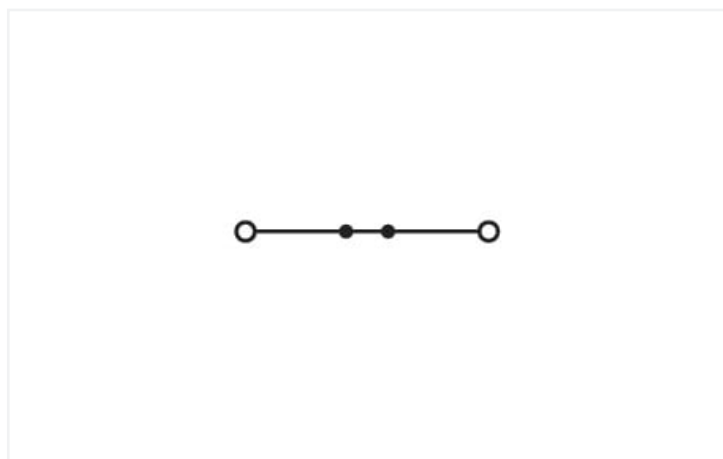

Similar to illustration

Electrical data

Ratings per	IEC/EN 60947-7-1		
Overvoltage category	III	III	II
Pollution degree	3	2	2
Nominal voltage	800 V	-	-
Rated surge voltage	8 kV	-	-
Rated current	13.5 A	-	-
Current at conductor cross-section (max.) mm ²	17.5 A	-	-

Approvals per	UL 1059		
Use group	B	C	D
Rated voltage	600 V	600 V	-
Rated current	10 A	10 A	-

Approvals per	CSA 22.2 No 158		
Use group	B	C	D
Rated voltage	600 V	600 V	-
Rated current	10 A	10 A	-

Ex information	
Reference hazardous areas	See "Downloads – Documentation – Additional Information: Technical Section; Technical Explanations"
Ratings per	ATEX: PTB 18 ATEX 1004 U / IECEx: PTB 18.0010U (Ex eb IIC Gb)
Rated voltage EN (Ex e II)	550 V
Rated current (Ex e II)	13 A
Rated current (Ex e II) with jumper	12 A

Power Loss

Power loss, per pole (potential)	0.7711 W
Rated current I_N for specified power loss	18 A
Resistance value for specified, current-dependent power loss	0.00238 Ω

Connection data

Clamping units	2
Total number of potentials	1
Number of levels	1
Number of jumper slots	2

Connection 1

Connection technology	Push-in CAGE CLAMP®
Actuation type	Push-button
Connectable conductor materials	Copper
Nominal cross-section	1 mm ²
Solid conductor	0.14 ... 1.5 mm ² / 24 ... 16 AWG
Solid conductor; push-in termination	0.5 ... 1.5 mm ² / 20 ... 16 AWG
Fine-stranded conductor	0.14 ... 1.5 mm ² / 24 ... 16 AWG
Fine-stranded conductor; with insulated ferrule	0.14 ... 0.75 mm ² / 24 ... 18 AWG
Fine-stranded conductor; with ferrule; push-in termination	0.5 ... 0.75 mm ² / 20 ... 18 AWG
Note (conductor cross-section)	Depending on the conductor characteristic, a conductor with a smaller cross-section can also be inserted via push-in termination.
Strip length	9 ... 11 mm / 0.35 ... 0.43 inches
Wiring direction	Front-entry wiring

Physical data

Width	3.5 mm / 0.138 inches
Height	48.5 mm / 1.909 inches
Depth from upper-edge of DIN-rail	32.9 mm / 1.295 inches
Depth	39.5 mm / 1.555 inches

Mechanical data

Mounting type	DIN-35 rail
Marking level	Center/side marking

Material data

Note (material data)	Information on material specifications can be found here
Color	gray
Material group	I
Insulation material (main housing)	Polyamide (PA66)
Flammability class per UL94	V0
Fire load	0.134 MJ
Actuator color	orange
Weight	3.7 g

Environmental requirements

Processing temperature	-35 ... +85 °C
Continuous operating temperature	-60 ... +105 °C

Environmental Testing (Environmental Conditions)

Test specification Railway applications – Rolling stock – Electronic equipment	DIN EN 50155 (VDE 0115-200):2022-06
Test procedure Railway applications – Rolling stock equipment – Shock and vibration tests	DIN EN 61373 (VDE 0115-0106):2011-04
Spectrum/Installation location	Service life test, Category 1, Class A/B
Function test with noise-like vibration	Test passed according to Section 8 of the standard
Frequency	$f_1 = 5 \text{ Hz}$ to $f_2 = 150 \text{ Hz}$ $f_1 = 5 \text{ Hz}$ to $f_2 = 150 \text{ Hz}$
Acceleration	0.101g (highest test level used for all axes) 0.572g (highest test level used for all axes) 5g (highest test level used for all axes)
Test duration per axis	10 min. 5 h
Test directions	X, Y and Z axes X, Y and Z axes X, Y and Z axes
Monitoring for contact faults/interruptions	Passed
Voltage drop measurement before and after each axis	Passed
Simulated service life test through increased levels of noise-like vibration	Test passed according to Section 9 of the standard
Extended test scope: Monitoring for contact faults/interruptions	Passed Passed
Extended test scope: Voltage drop measurement before and after each axis	Passed Passed
Shock test	Test passed according to Section 10 of the standard
Shock form	Half sine
Shock duration	30 ms
Number of shocks per axis	3 pos. und 3 neg.
Vibration and shock stress for rolling stock equipment	Passed

Commercial data

eCl@ss 10.0	27-14-11-20
eCl@ss 9.0	27-14-11-20
ETIM 9.0	EC000897
ETIM 8.0	EC000897
PU (SPU)	100 pcs
Packaging type	Box
Country of origin	DE
GTIN	4055143691543
Customs tariff number	85369010000

Environmental Product Compliance

RoHS Compliance Status

Compliant, No Exemption

Approvals / Certificates

General approvals



Approval	Standard	Certificate Name
CCA DEKRA Certification B.V.	EN 60947	NTR NL 7663
CSA DEKRA Certification B.V.	C22.2	70173737
cURus Underwriters Laboratories Inc.	UL 1059	E45172
KEMA/KEUR DEKRA Certification B.V.	IEC 60947	71-102874

Declarations of conformity and manufacturer's declarations



Approval	Standard	Certificate Name
ATEX-Attestation of Conformity WAGO GmbH & Co. KG	-	-
EU-Declaration of Conformity WAGO GmbH & Co. KG	-	-
Railway WAGO GmbH & Co. KG	-	Z00004402.000
UK-Declaration of Conformity WAGO GmbH & Co. KG	-	-

Approvals for marine applications



Approval	Standard	Certificate Name
ABS American Bureau of Shipping	-	19-HG1866350-PDA
BV Bureau Veritas S.A.	IEC 60947	58186/A0 BV
DNV GL Det Norske Veritas, Germanischer Lloyd	-	TAE00003JT
LR Lloyds Register	-	19/20050

Approvals for hazardous areas



Approval	Standard	Certificate Name
AEx Underwriters Laboratories Inc.	UL 60079	E185892 (AEx eb IIC resp. Ex eb IIC)
ATEX Physikalisch Technische Bundesanstalt	IEC 60079-0	PTB 18 ATEX 1003 U (II 2 G Ex eb II C Gb bzw. I M 2 Ex eb I Mb)
CCC CQST/CNEx	GB/T 3836.3	2020312313000166 (Ex eb IIC Gb, Ex eb I Mb)
EAC Brjansker Zertifizierungsstelle	TP TC 012/2011	RU C-DE.AM02. B.00127/19 (Ex e IIC Gb U)
IECEx Physikalisch Technische Bundesanstalt	IEC 60079	IECEx PTB 18.0010U (Ex eb IIC Gb and Ex eb I Mb)
INMETRO TÜV Rheinland do Brasil Ltda.	IEC 60079	TÜV 19.0820 U

Downloads

Environmental Product Compliance

Compliance Search

Environmental Product Compliance 2200-1201



Documentation

Additional Information

Technical Section	pdf 2246.92 KB	↓
-------------------	-------------------	-------------------

Bid Text

2200-1201	19.02.2019	xml 3.75 KB	↓
2200-1201	08.08.2018	docx 14.58 KB	↓

CAD/CAE-Data

CAD data

2D/3D Models 2200-1201	↓
---------------------------	-------------------

CAE data

EPLAN Data Portal 2200-1201	↓
ZUKEN Portal 2200-1201	↓

1 Compatible Products

1.1 Required Accessories

1.1.1 End plate

1.1.1.1 End plate



Item No.: 2000-1291
End and intermediate plate; 0.7 mm thick; gray



Item No.: 2000-1292
End and intermediate plate; 0.7 mm thick; orange



Item No.: 209-191
Separator for Ex e/Ex i applications; 3 mm thick; 120 mm wide; orange

1.2 Optional Accessories

1.2.1 DIN-rail

1.2.1.1 Mounting accessories



Item No.: 210-196
Aluminum carrier rail; 35 x 8.2 mm; 1.6 mm thick; 2 m long; unslotted; similar to EN 60715; silver-colored



Item No.: 210-198
Copper carrier rail; 35 x 15 mm; 2.3 mm thick; 2 m long; unslotted; according to EN 60715; copper-colored



Item No.: 210-197
Steel carrier rail; 35 x 15 mm; 1.5 mm thick; 2 m long; slotted; similar to EN 60715; silver-colored



Item No.: 210-114
Steel carrier rail; 35 x 15 mm; 1.5 mm thick; 2 m long; unslotted; similar to EN 60715; silver-colored



Item No.: 210-118
Steel carrier rail; 35 x 15 mm; 2.3 mm thick; 2 m long; unslotted; according to EN 60715; silver-colored



Item No.: 210-115
Steel carrier rail; 35 x 7.5 mm; 1 mm thick; 2 m long; slotted; according to EN 60715; "Hole width 18 mm; silver-colored



Item No.: 210-112
Steel carrier rail; 35 x 7.5 mm; 1 mm thick; 2 m long; slotted; according to EN 60715; "Hole width 25 mm; silver-colored



Item No.: 210-113
Steel carrier rail; 35 x 7.5 mm; 1 mm thick; 2 m long; unslotted; according to EN 60715; silver-colored

1.2.2 End plate

1.2.2.1 End plate



Item No.: [209-190](#)

Separator for Ex e/Ex i applications; 3 mm thick; 90 mm wide; orange

1.2.3 Ferrule

1.2.3.1 Ferrule



Item No.: [216-241](#)

Ferrule; Sleeve for 0.5 mm² / 20 AWG; insulated; electro-tin plated; electrolytic copper; gastight crimped; acc. to DIN 46228, Part 4/09.90; white



Item No.: [216-242](#)

Ferrule; Sleeve for 0.75 mm² / 18 AWG; insulated; electro-tin plated; electrolytic copper; gastight crimped; acc. to DIN 46228, Part 4/09.90; gray



Item No.: [216-243](#)

Ferrule; Sleeve for 1 mm² / AWG 18; insulated; electro-tin plated; electrolytic copper; gastight crimped; acc. to DIN 46228, Part 4/09.90; red

1.2.4 Installation

1.2.4.1 Cover



Item No.: [709-156](#)

Cover; Type 3; suitable for cover carrier, type 3; 1 m long; transparent

1.2.4.2 Cover carrier



Item No.: [709-169](#)

Cover carrier; Type 3; incl. fixing/retaining screws and knurled nut; suitable for 279 to 282 and 880 Series rail-mounted terminal blocks; suitable for 264 Series miniature rail-mounted terminal blocks; suitable for 270 Series sensor and actuator terminal blocks; gray

1.2.5 Jumper

1.2.5.1 Jumper



Item No.: [2000-406/020-000](#)

Delta jumper; insulated; light gray



Item No.: [2000-410/000-006](#)

Jumper; 10-way; insulated; blue



Item No.: [2000-410](#)

Jumper; 10-way; insulated; light gray



Item No.: [2000-410/000-005](#)

Jumper; 10-way; insulated; red



Item No.: [2000-402/000-006](#)

Jumper; 2-way; insulated; blue



Item No.: [2000-402](#)

Jumper; 2-way; insulated; light gray



Item No.: [2000-402/000-005](#)

Jumper; 2-way; insulated; red



Item No.: [2000-402/000-018](#)

Jumper; 2-way; insulated; yellow-green



Item No.: [2000-403/000-006](#)

Jumper; 3-way; insulated; blue



Item No.: [2000-403](#)

Jumper; 3-way; insulated; light gray



Item No.: [2000-403/000-005](#)































Jumper; 3-way; insulated; red



Item No.: [2000-404/000-006](#)











Jumper; 4-way; insulated; blue

1.2.5.1 Jumper

 Item No.: 2000-404 Jumper; 4-way; insulated; light gray	 Item No.: 2000-404/000-005 Jumper; 4-way; insulated; red	 Item No.: 2000-405/000-006 Jumper; 5-way; insulated; blue	 Item No.: 2000-405 Jumper; 5-way; insulated; light gray
 Item No.: 2000-405/000-005 Jumper; 5-way; insulated; red	 Item No.: 2000-406/000-006 Jumper; 6-way; insulated; blue	 Item No.: 2000-406 Jumper; 6-way; insulated; light gray	 Item No.: 2000-406/000-005 Jumper; 6-way; insulated; red
 Item No.: 2000-407/000-006 Jumper; 7-way; insulated; blue	 Item No.: 2000-407 Jumper; 7-way; insulated; light gray	 Item No.: 2000-407/000-005 Jumper; 7-way; insulated; red	 Item No.: 2000-408/000-006 Jumper; 8-way; insulated; blue
 Item No.: 2000-408 Jumper; 8-way; insulated; light gray	 Item No.: 2000-408/000-005 Jumper; 8-way; insulated; red	 Item No.: 2000-409/000-006 Jumper; 9-way; insulated; blue	 Item No.: 2000-409 Jumper; 9-way; insulated; light gray
 Item No.: 2000-409/000-005 Jumper; 9-way; insulated; red	 Item No.: 2000-440 Jumper; from 1 to 10; insulated; light gray	 Item No.: 2000-433/000-006 Jumper; from 1 to 3; insulated; blue	 Item No.: 2000-433 Jumper; from 1 to 3; insulated; light gray
 Item No.: 2000-433/000-005 Jumper; from 1 to 3; insulated; red	 Item No.: 2000-434 Jumper; from 1 to 4; insulated; light gray	 Item No.: 2000-435 Jumper; from 1 to 5; insulated; light gray	 Item No.: 2000-436 Jumper; from 1 to 6; insulated; light gray
 Item No.: 2000-437 Jumper; from 1 to 7; insulated; light gray	 Item No.: 2000-438 Jumper; from 1 to 8; insulated; light gray	 Item No.: 2000-439 Jumper; from 1 to 9; insulated; light gray	 Item No.: 2000-405/011-000 Star point jumper; 3-way; insulated; light gray
 Item No.: 210-103 Wire commoning chain; insulated; black	 Item No.: 210-123 Wire commoning chain; insulated; blue		

1.2.6 Marking

1.2.6.1 Marker

 Item No.: 793-3501 WMB marking card; as card; plain; snap-on type; white	 Item No.: 2009-113/000-006 WMB-Inline; for Smart Printer; 2300 pieces on roll; plain; snap-on type; blue	 Item No.: 2009-113/000-007 WMB-Inline; for Smart Printer; 2300 pieces on roll; plain; snap-on type; gray	 Item No.: 2009-113/000-023 WMB-Inline; for Smart Printer; 2300 pieces on roll; plain; snap-on type; green
 Item No.: 2009-113/000-017 WMB-Inline; for Smart Printer; 2300 pieces on roll; plain; snap-on type; light green	 Item No.: 2009-113/000-012 WMB-Inline; for Smart Printer; 2300 pieces on roll; plain; snap-on type; orange	 Item No.: 2009-113/000-005 WMB-Inline; for Smart Printer; 2300 pieces on roll; plain; snap-on type; red	 Item No.: 2009-113/000-024 WMB-Inline; for Smart Printer; 2300 pieces on roll; plain; snap-on type; violet
 Item No.: 2009-113 WMB-Inline; for Smart Printer; 2300 pieces on roll; plain; snap-on type; white	 Item No.: 2009-113/000-002 WMB-Inline; for Smart Printer; 2300 pieces on roll; plain; snap-on type; yellow		

1.2.6.2 Marking strip



Item No.: 2009-110

Marking strips; for Smart Printer; on reel; not stretchable; plain; snap-on type; white

1.2.7 Push-in type wire jumper

1.2.7.1 Jumper



Item No.: 2009-404

Push-in type wire jumper; 0.75 mm²; insulated; 110 mm long; gray



Item No.: 2009-406

Push-in type wire jumper; 0.75 mm²; insulated; 250 mm long; gray



Item No.: 2009-402

Push-in type wire jumper; 0.75 mm²; insulated; 60 mm long; gray

1.2.8 Screwless end stop

1.2.8.1 Mounting accessories



Item No.: 249-117

Screwless end stop; 10 mm wide; for DIN-rail 35 x 15 and 35 x 7.5; gray



Item No.: 249-116

Screwless end stop; 6 mm wide; for DIN-rail 35 x 15 and 35 x 7.5; gray

1.2.9 Test and measurement

1.2.9.1 Testing accessories



Item No.: 2000-560

Modular TOPJOB®S connector; modular; for jumper contact slot; 10-pole; 1,00 mm²; gray



Item No.: 2000-552

Modular TOPJOB®S connector; modular; for jumper contact slot; 2-pole; 1,00 mm²; gray



Item No.: 2000-553

Modular TOPJOB®S connector; modular; for jumper contact slot; 3-pole; 1,00 mm²; gray



Item No.: 2000-554

Modular TOPJOB®S connector; modular; for jumper contact slot; 4-pole; 1,00 mm²; gray



Item No.: 2000-555

Modular TOPJOB®S connector; modular; for jumper contact slot; 5-pole; 1,00 mm²; gray



Item No.: 2000-556

Modular TOPJOB®S connector; modular; for jumper contact slot; 6-pole; 1,00 mm²; gray



Item No.: 2000-557

Modular TOPJOB®S connector; modular; for jumper contact slot; 7-pole; 1,00 mm²; gray



Item No.: 2000-558

Modular TOPJOB®S connector; modular; for jumper contact slot; 8-pole; 1,00 mm²; gray



Item No.: 2000-559

Modular TOPJOB®S connector; modular; for jumper contact slot; 9-pole; 1,00 mm²; gray



Item No.: 2000-549

Spacer module; modular; e.g., for bridging commoned terminal blocks; gray



Item No.: 2009-174

Test plug adapter; for 4 mm Ø test plugs; for testing TOPJOB®S rail-mounted terminal blocks; gray



Item No.: 210-136

Test plug; 2 mm Ø; with 500 mm cable; red



Item No.: 2009-182

Testing tap; for max. 2.5 mm²; tool-free connection for individual test wires 0.08 - 2.5 mm; gray



Item No.: 2000-510

TOPJOB®S L-type test plug module; modular; for jumper contact slot; 1,00 mm²; gray



Item No.: 2000-511

TOPJOB®S L-type test plug module; modular; for jumper contact slot; 1-pole; 1,00 mm²; gray

1.2.10 Tool

1.2.10.1 Operating tool



Item No.: 210-719

Operating tool; Blade: 2.5 x 0.4 mm; with a partially insulated shaft



Item No.: 210-648

Operating tool; Blade: 2.5 x 0.4 mm; with a partially insulated shaft; angled; short



Item No.: 210-647

Operating tool; Blade: 2.5 x 0.4 mm; with a partially insulated shaft; multicoloured

Installation Notes

Conductor termination



All conductor types at a glance



Push-in termination of solid and ferruled conductors



Insert fine-stranded conductors via operating tool.



Removing all conductors via operating tool.

Commoning

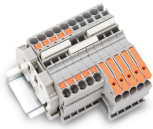

Insert a push-in type jumper bar and push down until it hits the backstop.



Commoning with step-down jumpers.

Testing



Testing with a 2 mm Ø test plug (max. 42 V).

Marking

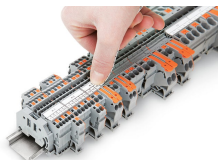

Snapping a marking strip into a marker slot.



Snapping a marking strip into the marker slot.