

KLEIN TOOLS®



For Professionals... Since 1857™

Test & Measurement Range

• MULTIMETERS • CLAMP METERS • ELECTRICAL TESTERS •



MUMME TOOLS



MM600

Test & Measurement Range

Designed by Electricians for Electricians

Klein Tools has been manufacturing professional hand tools for over 150 years. The company is dedicated to providing the best hand tools in the industry and supporting electricians and professional trades people around the world with quality and reliability they can count on everyday. Blending innovation with functionality has built Klein's global reputation as a leading producer of quality products.

The **Test & Measurement product line** has been exclusively designed from the ground up – by electricians for electricians – working side by side with Klein's team of engineers and product experts. Based on years of field research, combined with extensive input from electricians across America, these meters and testers were specifically loaded with the latest innovative, time-saving features designed to meet and exceed their specific job requirements.



CL800

Within each product classification, Klein's meters and testers boast more features than comparable products in the category. That translates to more efficiency on the job, additional benefits to the user, and superior value overall. Some of Klein's innovative features (which vary by model) include:

- **Large Backlit Displays**
- **High Safety Ratings**
- **Analogue Bar Graphs**
- **Low Impedance**
- **Magnetic Mounts**
- **Work Lights**
- **Unique Clamp Design and more!**



IR2000A



CL3200



Electricians know that quality and durability matter. Klein knows that electricians have a critical need for accuracy and safety in everything they do. The world today demands time-savings and efficiency on every jobsite. Klein Tools Test and Measurement products deliver!

CLAMP METERS

04-11

SELECTION GUIDE	04	CL2500	09
CL110	07	CL3200 	10
CL310	08	ACCESSORIES	11
CL700 	05		
CL800 	06		

MULTIMETERS

12-17

SELECTION GUIDE	12	ACCESSORIES	17
MM300	15		
MM400	16		
MM600 	13		
MM700 	14		

ELECTRICAL TESTERS

18-19

ET200	18
ET300AU	19

NON-CONTACT VOLTAGE TESTERS 20-21

NCVT-1 Standard Voltage	20
NCVT-3 with Flashlight 	21

INFRARED THERMOMETERS

22-23

IR1000	22
IR2000A 	23

 **WARNING:** Read, understand, and follow all instructions, cautions and warnings attached to and/or packed with all test and measurement devices before each use.

CLAMP METERS



FEATURES	CL110	CL310	CL700	CL800	CL2500	CL3200
Durability						
Drop Protection	1 m	1 m	2 m	2 m	1 m	2 m
Ingress Protection	—	—	IP40	IP40	IP42	—
Safety	CAT III 600V	CAT III 600V	CAT IV 600V	CAT IV 600V	CAT IV 600V	CAT IV 600V
AC Voltage (Volts)	600V	600V	1000V	1000V	750V	750V
DC Voltage (Volts)	600V	600V	1000V	1000V	1000V	1000V
AC Current (Amps)	400A	400A	600A	600A	1000A	200A
DC Current (Amps)	—	—	—	600A	1000A	—
Ohms (Resistance)	20MΩ	40MΩ	60MΩ	60MΩ	60MΩ	40MΩ
AC Millivolts	●	—	—	—	●	—
DC Millivolts	●	●	●	●	●	—
True RMS	—	●	●	●	●	—
Audible Continuity	●	●	●	●	●	●
Backlight	●	●	●	●	●	●
Temperature	—	-40° – 1000°C (-40° – 1832°F)	-26° – 538°C (-14° – 1000°F)	-26° – 538°C (-14° – 1000°F)	—	—
Low Impedance	—	—	●	●	—	●
Non-Contact Voltage Testing	—	—	●	●	●	●
Auto Ranging	●	●	●	●	●	●
Range Hold	●	●	●	●	●	—
Data Hold	●	●	●	●	●	●
Diode Test	—	●	●	●	●	—
Capacitance Test	—	4000 μF	6000 μF	6000 μF	6000 μF	—
Frequency / Duty Cycle	—	10Hz – 1MHz	1Hz – 500 KHz	1Hz – 500 KHz	499.9 KHz	—
Max / Min	MAX only	●	●	●	●	—
Worklight	—	—	—	●	●	●
Auto-Power Off	●	●	●	●	●	●
LCD Display Count	2000	4000	6000	6000	6000	4000

Specifications subject to change.

CL700

600A AC TRMS Clamp Meter

The **CL700** is an auto-ranging True Root-Mean-Squared (TRMS) digital clamp meter that measures AC current via the clamp, and measures AC/DC voltage, resistance, continuity, frequency, capacitance, and tests diodes via test leads, and temperature via a thermocouple probe. It also features a Low Impedance (LoZ) mode for identifying and eliminating ghost or stray voltages.

Includes a nylon carrying pouch, test leads, batteries and thermocouple with adapter.

FEATURES	CL700
Durability	
Drop Protection	2 m
Ingress Protection	IP40
Safety	CAT IV 600V
AC Voltage (Volts)	1000V
DC Voltage (Volts)	1000V
AC Current (Amps)	600A
DC Current (Amps)	—
Ohms (Resistance)	60MΩ
True RMS	●
Audible Continuity	●
Backlight	●
Temperature	-26° – 538°C (-14° – 1000°F)
Non-Contact Voltage Testing	●
Auto Ranging	●
Capacitance Test	6000 μF
Frequency / Duty Cycle	1Hz – 500 KHz
Worklight	—



CL800



















600A AC/DC TRMS Clamp Meter

The **CL800** is an auto-ranging True Root-Mean-Squared (TRMS) digital clamp meter that measures AC/DC current via the clamp, measures AC/DC voltage, resistance, continuity, frequency, capacitance, and tests diodes via test leads, and temperature via a thermocouple probe. It also features a Low Impedance (LoZ) mode for identifying and eliminating ghost or stray voltages.

Includes a nylon carrying pouch, test leads, batteries and thermocouple with adapter.

FEATURES

CL800

 Durability	
 Drop Protection	2 m
 Ingress Protection	IP40
 Safety	CAT IV 600V
 AC Voltage (Volts)	1000V
 DC Voltage (Volts)	1000V
 AC Current (Amps)	600A
 DC Current (Amps)	600A
 Ohms (Resistance)	60MΩ
 True RMS	●
 Audible Continuity	●
 Backlight	●
 Temperature	-26° - 538°C (-14° - 1000°F)
 Non-Contact Voltage Testing	●
 Auto Ranging	●
 Capacitance Test	6000 μF
 Frequency / Duty Cycle	1Hz - 500 KHz
 Worklight	●

Clamp trigger



TOUGH METER

Non-contact voltage testing sensor

Test lead holder

Function selector switch

Function buttons

LCD display

Test lead input jacks



CL110

400A AC Clamp Meter

The **CL110** is an auto-ranging digital clamp meter that measures AC current via the clamp, and AC/DC voltage, resistance and continuity via test leads.

Includes a nylon carrying pouch, test leads and batteries.

FEATURES	CL110
Durability	
Drop Protection	1 m
Ingress Protection	—
Safety	CAT III 600V
AC Voltage (Volts)	600V
DC Voltage (Volts)	600V
AC Current (Amps)	400A
DC Current (Amps)	—
Ohms (Resistance)	20M Ω
True RMS	—
Audible Continuity	●
Backlight	●
Temperature	—
Non-Contact Voltage Testing	—
Auto Ranging	●
Capacitance Test	—
Frequency / Duty Cycle	—
Worklight	—

Clamp trigger

Function selector switch

LCD display

Function buttons

Test lead input jacks



Included:

- Nylon carrying pouch
- Test leads with CAT III/CAT IV safety caps
- Batteries

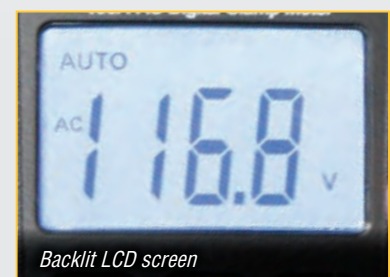

Backlit LCD screen

CL310

400A AC TRMS Clamp Meter

The **CL310** is an auto-ranging True Root-Mean-Squared (TRMS) digital clamp meter that measures AC current via the clamp, AC/DC voltage, resistance, continuity, frequency, capacitance, and tests diodes via test leads, and temperature via a thermocouple probe.

Includes a nylon carrying pouch, test leads, thermocouple and batteries.

FEATURES	CL310
Durability	
Drop Protection	1 m
Ingress Protection	—
Safety	CAT III 600V
AC Voltage (Volts)	600V
DC Voltage (Volts)	600V
AC Current (Amps)	400A
DC Current (Amps)	—
Ohms (Resistance)	40MΩ
True RMS	●
Audible Continuity	●
Backlight	●
Temperature	-40° – 1000°C (-40° – 1832°F)
Non-Contact Voltage Testing	—
Auto Ranging	●
Capacitance Test	4000 μF
Frequency / Duty Cycle	10Hz – 1MHz
Worklight	—

Clamp trigger

Function selector switch

LCD display

Function buttons

Test lead input jacks



Included:

- Nylon carrying pouch
- Test leads with CAT III/CAT IV safety caps
- Batteries
- Thermocouple

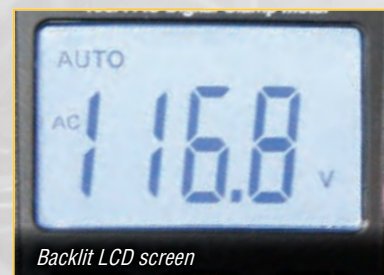
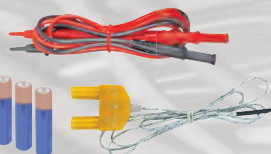

Backlit LCD screen

CL2500

1000A AC/DC TRMS Clamp Meter

The **CL2500** is an auto-ranging True Root-Mean-Squared (TRMS) digital clamp meter that measures AC and DC current up to 1000A via the clamp, AC/DC voltage, resistance, continuity, frequency, capacitance, and tests diodes via test leads.

Includes a nylon carrying pouch, test leads and batteries.

FEATURES	CL2500
Durability	
Drop Protection	1 m
Ingress Protection	IP42
Safety	CAT IV 600V
AC Voltage (Volts)	750V
DC Voltage (Volts)	1000V
AC Current (Amps)	1000A
DC Current (Amps)	1000A
Ohms (Resistance)	60MΩ
True RMS	●
Audible Continuity	●
Backlight	●
Temperature	—
Non-Contact Voltage Testing	●
Auto Ranging	●
Capacitance Test	6000 μF
Frequency / Duty Cycle	499.9 KHz
Worklight	●



CL3200

200A AC Fork Meter

The **CL3200** is an auto-ranging digital fork meter that measures AC current via the extra large jaw opening, AC/DC voltage, resistance and continuity via test leads. Extra large jaw opening accepts 3/0 wire.

Includes a nylon carrying pouch, test leads and batteries.

TOUGH METER

FEATURES	CL3200
Durability	
Drop Protection	2 m
Ingress Protection	—
Safety	CAT IV 600V
AC Voltage (Volts)	750V
DC Voltage (Volts)	1000V
AC Current (Amps)	200A
DC Current (Amps)	—
Ohms (Resistance)	40MΩ
True RMS	—
Audible Continuity	●
Backlight	●
Temperature	—
Non-Contact Voltage Testing	●
Auto Ranging	●
Capacitance Test	—
Frequency / Duty Cycle	—
Worklight	●

Non-contact voltage testing sensor



Function selector switch

LCD display

Test lead input jacks

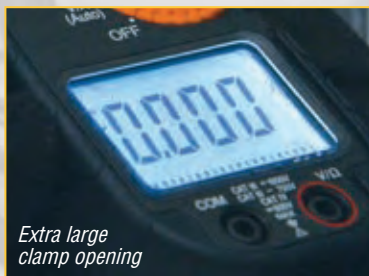

Clamp Meter Specifications

Cat. No.	CAT Rating	Batteries	Jaw Size (mm)	Height (mm)	Width (mm)	Depth (mm)	Weight (g)	Included
CL110	CAT III 600V	2 x AAA	25	220	77	41	280	nylon case, test leads
CL310	CAT III 600V	2 x AAA	25	220	77	41	280	nylon case, test leads, thermocouple
CL700	CAT IV 600V	2 x AAA	32	231	97	39	335	nylon case, test leads, thermocouple
CL800	CAT IV 600V	2 x AAA	32	231	97	39	335	nylon case, test leads, thermocouple
CL2500	CAT IV 600V	2 x AAA	50	205	65	35	386	nylon case, test leads
CL3200	CAT IV 600V	2 x AAA	16	179	65	34	224	nylon case, test leads

⚠ WARNINGS:

To ensure safe operation and service of the tester, follow these instructions. Failure to observe these warnings can result in severe injury or death.

- Before each use, verify meter operation by measuring a known voltage or current.
- Never use the meter on a circuit with voltages that exceed the category based rating of this meter.
- Do not use the meter during electrical storms, or in wet weather.
- Do not use the meter or test leads if they appear to be damaged.
- Ensure meter leads are fully seated, and keep fingers away from the metal probe contacts when making measurements.
- Do not open the meter to replace batteries while the probes are connected.
- Use caution when working with voltages above 60V DC, or 25V AC RMS. Such voltages pose a shock hazard.
- To avoid false readings that can lead to electrical shock, replace batteries if a low battery indicator appears.
- Unless measuring voltage or current, shut off and lock out power before measuring resistance or capacitance.
- Always adhere to local and national safety codes. Use individual protective equipment to prevent shock and arc blast injury where hazardous live conductors are exposed.

Replacement Test Leads

- Standard banana-type inputs compatible with most multimeters and clamp meters
- Leads compatible with and fit lead storage compartments on most Klein meters
- Includes one pair each of universal test leads and alligator clips
- Safety rating: CAT III 1000V / CAT IV 600V

Additional Features for Premium Silicone Test Lead Set

- Silicone insulated for greater performance in temperature extremes -20° to 55°C
- Enhanced strain relief and durability
- Built-in wear indicator on probe wires

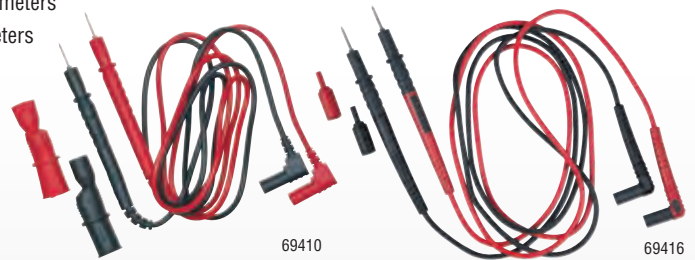

Cat. No.	Description	Overall Length (m)	Weight (g)
69410	universal test lead set	1.07	91
69416	premium silicone test lead set	1.22	96

Tradesman PRO™ Soft Case

- Two layers of padding protect even delicate instruments
- Heavy-duty zipper and rugged PVC coated polyester for durability
- Pockets for quick access and organization
- Loop with snap closure to attach to belts, bags and backpacks
- For meters, testers, infrared guns, and small tools



Cat. No.	Width (mm)	Height (mm)	Depth (mm)	Weight (g)
69406	114	235	57	177

Tradesman PRO™ Hard Cases



- Hard shell protects tools, meters, small parts and tech devices
- Soft interior lining
- Durable zipper closure

Cat. No.	Width (mm)	Height (mm)	Depth (mm)	Weight (g)
5184	165	222	57	286
5189	140	260	57	286

MULTIMETERS



FEATURES	MM300	MM400	MM600	MM700
Durability				
Drop Protection	1 m	1 m	2 m	2 m
Ingress Protection	—	—	IP42	IP42
Safety	CAT III 600V	CAT III 600V	CAT IV 600V	CAT IV 600V
AC Voltage (Volts)	600V	600V	1000V	1000V
DC Voltage (Volts)	600V	600V	1000V	1000V
AC Current (Amps)	—	10A	10A	10A
DC Current (Amps)	10A	10A	10A	10A
Ohms (Resistance)	2M Ω	40M Ω	40M Ω	40M Ω
DC Millivolts	●	●	●	●
AC Milliamps	—	●	●	●
DC Milliamps	●	●	●	●
AC Microamps	—	●	●	●
DC Microamps	●	●	●	●
True RMS	—	—	—	●
Audible Continuity	●	●	●	●
Backlight	—	●	●	●
Temperature	—	-18° – 538°C (0° – 1000°F)	-18° – 538°C (0° – 1000°F)	-18° – 816°C (0° – 1500°F)
Low Impedance	—	—	—	●
Auto Ranging	—	●	●	●
Range Hold	—	●	●	●
Data Hold	●	●	●	●
Diode Test	●	●	●	●
Capacitance Test	—	200 μ F	1000 μ F	4000 μ F
Frequency / Duty Cycle	—	1Hz – 50 KHz	1Hz – 500 KHz	1Hz – 500 KHz
Max / Min	—	●	●	●
Lead Warning	—	—	●	●
Bar Graph	—	—	—	●
Auto-Power Off	—	●	●	●
Battery Test	●	—	—	—
LCD Display Count	2000	4000	4000	4000

Specifications subject to change.

MM600

1000V AC/DC Digital Multimeter

The **MM600** is an auto-ranging digital multimeter that measures AC/DC voltage, AC/DC current, and resistance. It also measures temperature, capacitance, frequency, duty-cycle, and tests diodes and continuity.

Includes a nylon carrying pouch, test leads, alligator clips, batteries and thermocouple with adapter.

TOUGH METER

FEATURES	MM600
Durability	
Drop Protection	2 m
Ingress Protection	IP42
Safety	CAT IV 600V
AC Voltage (Volts)	1000V
DC Voltage (Volts)	1000V
AC Current (Amps)	10A
DC Current (Amps)	10A
Ohms (Resistance)	40MΩ
True RMS	—
Audible Continuity	●
Backlight	●
Temperature	-18° – 538°C (0° – 1000°F)
Auto Ranging	●
Capacitance Test	1000 μF
Frequency / Duty Cycle	1Hz – 500 KHz

LCD display

Function buttons

Function selector switch

Test lead input jacks



Backlit LCD screen



Lead storage

MM700

1000V AC/DC TRMS Digital Multimeter

The **MM700** is an auto-ranging True Root-Mean-Squared (TRMS) digital multimeter that measures AC/DC voltage, AC/DC current, and resistance. It also measures temperature, capacitance, frequency, duty-cycle, and tests diodes and continuity.

Includes a nylon carrying pouch, test leads, alligator clips, batteries and thermocouple with adapter.

**TOUGH
METER**

FEATURES	MM700
Durability	
Drop Protection	2 m
Ingress Protection	IP42
Safety	CAT IV 600V
AC Voltage (Volts)	1000V
DC Voltage (Volts)	1000V
AC Current (Amps)	10A
DC Current (Amps)	10A
Ohms (Resistance)	40M Ω
True RMS	●
Audible Continuity	●
Backlight	●
Temperature	-18° - 816°C (0° - 1500°F)
Auto Ranging	●
Capacitance Test	4000 μ F
Frequency / Duty Cycle	1Hz - 500 KHz

LCD display

Function buttons

Function selector switch

Test lead input jacks



Backlit LCD screen



















Lead storage

MM300

600V Manual Ranging Digital Multimeter

The **MM300** is a manual-ranging digital multimeter that measures AC/DC voltage, DC current, and resistance. It also tests diodes and continuity, and has a battery test mode.

Includes test leads and batteries.

FEATURES	MM300
 Durability	
 Drop Protection	1 m
 Ingress Protection	—
 Safety	CAT III 600V
 AC Voltage (Volts)	600V
 DC Voltage (Volts)	600V
 AC Current (Amps)	—
 DC Current (Amps)	10A
 Ohms (Resistance)	2M Ω
 True RMS	—
 Audible Continuity	●
 Backlight	—
 Temperature	—
 Auto Ranging	—
 Capacitance Test	—
 Frequency / Duty Cycle	—



LCD display

Function selector switch

Test lead input jacks



INCLUDED:

- Test leads with CAT III/CAT IV safety caps
- Thermocouple with adapter
- Batteries



Backlit LCD screen

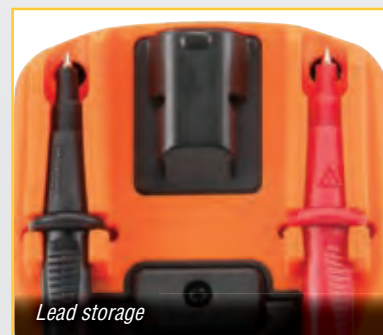

Lead storage

MM400

600V Manual Ranging Digital Multimeter with Temperature

The **MM400** is an auto-ranging digital multimeter that measures AC/DC voltage, AC/DC current, and resistance. It also measures temperature, capacitance, frequency, duty-cycle, and tests diodes and continuity.

Includes test leads, batteries and thermocouple with adapter.

FEATURES	MM400
Durability	
Drop Protection	1 m
Ingress Protection	—
Safety	CAT III 600V
AC Voltage (Volts)	600V
DC Voltage (Volts)	600V
AC Current (Amps)	10A
DC Current (Amps)	10A
Ohms (Resistance)	40MΩ
True RMS	—
Audible Continuity	●
Backlight	●
Temperature	-18° – 538°C (0° – 1000°F)
Auto Ranging	●
Capacitance Test	200 μF
Frequency / Duty Cycle	1Hz – 50 KHz



INCLUDED:

- Test leads with CAT III/CAT IV safety caps
- Thermocouple with adapter
- Batteries

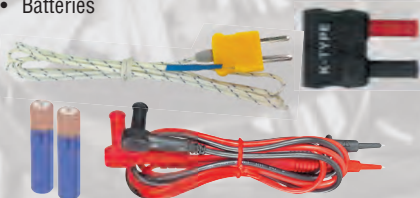

Backlit LCD screen

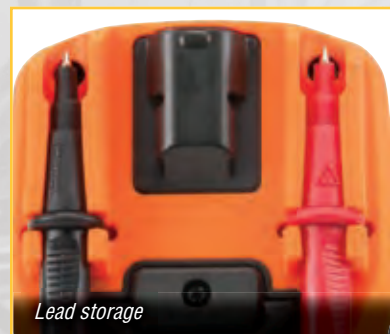

Lead storage

Multimeter Specifications

Cat. No.	CAT Rating	Batteries	Height (mm)	Width (mm)	Depth (mm)	Weight (g)	Included Accessories
MM300	CAT III 600V	2 x AAA	154	78	45	230	test leads
MM400	CAT III 600V	2 x AAA	154	78	45	230	test leads, thermocouple
MM600	CAT IV 600V	2 x AAA	178	90	53	414	nylon case, test leads, alligator clips, thermocouple
MM700	CAT IV 600V	2 x AAA	178	90	53	414	nylon case, test leads, alligator clips, thermocouple

⚠ WARNINGS:

To ensure safe operation and service of the tester, follow these instructions. Failure to observe these warnings can result in severe injury or death.

- Before each use, verify meter operation by measuring a known voltage or current.
- Never use the meter on a circuit with voltages that exceed the category based rating of this meter.
- Do not use the meter during electrical storms, or in wet weather.
- Do not use the meter or test leads if they appear to be damaged.
- Ensure meter leads are fully seated, and keep fingers away from the metal probe contacts when making measurements.
- Do not open the meter to replace batteries while the probes are connected.
- Use caution when working with voltages above 60V DC, or 25V AC RMS. Such voltages pose a shock hazard.
- To avoid false readings that can lead to electrical shock, replace batteries if a low battery indicator appears.
- Unless measuring voltage or current, shut off and lock out power before measuring resistance or capacitance.
- Always adhere to local and national safety codes. Use individual protective equipment to prevent shock and arc blast injury where hazardous live conductors are exposed.

Multimeter Replacement Fuses



69031 / 69032



69034 / 69035

Cat. No.	For Use With	Fuse Type
69031	MM300 / MM400	200mA / 600V fast-blow fuse
69032	MM300 / MM400	10A / 600V fast-blow fuse
69034	MM600 / MM700	10A / 1000V fast-blow fuse
69035	MM600 / MM700	500mA / 1000V fast-blow fuse

Replacement Test Leads

- Standard banana-type inputs compatible with most multimeters and clamp meters
- Leads compatible with and fit lead storage compartments on most Klein meters
- Includes one pair each of universal test leads and alligator clips
- Safety rating: CAT III 1000V / CAT IV 600V



69410



69416

Additional Features for Premium Silicone Test Lead Set

- Silicone insulated for greater performance in temperature extremes -20° to 55°C
- Enhanced strain relief and durability
- Built-in wear indicator on probe wires

Cat. No.	Description	Overall Length (m)	Weight (g)
69410	universal test lead set	1.07	91
69416	premium silicone test lead set	1.22	96

Tradesman PRO™ Soft Case

- Two layers of padding protect even delicate instruments
- Heavy-duty zipper and rugged PVC coated polyester for durability
- Pockets for quick access and organization
- Loop with snap closure to attach to belts, bags and backpacks
- For meters, testers, infrared guns, and small tools



69406

 Made in USA of US and imported parts.

Cat. No.	Width (mm)	Height (mm)	Depth (mm)	Weight (g)
69406	114	235	57	177

Tradesman PRO™ Hard Cases



5189



5184

- Hard shell protects tools, meters, small parts and tech devices
- Soft interior lining
- Durable zipper closure













Cat. No.	Width (mm)	Height (mm)	Depth (mm)	Weight (g)
5184	165	222	57	286
5189	140	260	57	286

ET200

600V Electronic Voltage Tester

Features

- Measures AC and DC voltage at nine common levels up to 600V
- Bright LEDs indicate voltage reading without batteries installed
- Low impedance input reduces possibility of ghost voltages
- Permanently secured test leads are always there when needed
- Vibration and sound alerts for dangerous voltage levels
- Modern solid-state construction for CAT IV 600V safety rating
- Bright light illuminates work area
- Audible continuity alerts at less than 270k Ω

FEATURES	ET200
 Durability	
 Drop Protection	1 m
 Ingress Protection	—
 Safety	CAT IV 600V
 AC Voltage (Volts)	600V
 DC Voltage (Volts)	600V
 AC Current (Amps)	—
 DC Current (Amps)	—
 Ohms (Resistance)	—
 True RMS	—
 Audible Continuity	•
 Worklight	•



Cat. No.	CAT Rating	Batteries	Height (mm)	Width (mm)	Depth (mm)	Weight (g)
ET200	CAT IV 600V	3 x AAA	187	60	32	230

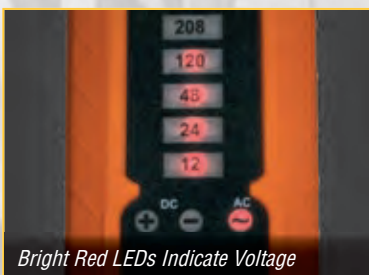

ET300AU

Digital Circuit Breaker Finder

Features

- Quickly, accurately, and automatically find the corresponding circuit breaker of any standard 230V and 240V outlet
- For use on powered circuits only
- Does not require interruption of service
- Bright green arrow and loud beeping tone provide clear indication of correct breaker
- Strong transmitter reaches distances of up to 305 metres (1,000 ft.)



5291



Cat. No.	CAT Rating	Batteries	Height (mm)	Width (mm)	Depth (mm)	Weight (g)
ET300AU	Receiver	1 x 9V	152	51	23	91
	Transmitter	—	71	48	31	45

Tradesman PRO™ Cases

- See page 17 for details



NCVT-1

Non-Contact Voltage Tester

Features

- Detects and indicates standard voltage (48-1000 Volts AC), allowing broad application
- High intensity, bright green LED indicates the tester is operational and aids in illuminating the workspace
- Digitally controlled ON/OFF power button
- Auto power-off feature conserves and extends battery life
- Microprocessor controlled low-battery indicator
- CAT IV 1000 Volt rating provides expanded operation and protection
- Lightweight durable polycarbonate plastic resin construction with a convenient pocket-clip



FEATURES

NCVT-1

 Durability



 Drop Protection

3 m

 Ingress Protection

—

 Safety

CAT IV
1000V

 AC Voltage Range (Volts)

48 - 1000V

 DC Voltage (Volts)

—

 Visual Indicator

•

 Audible Indicator

•

 Worklight

—

 Auto-Power Off

•

LED Visual Indicator

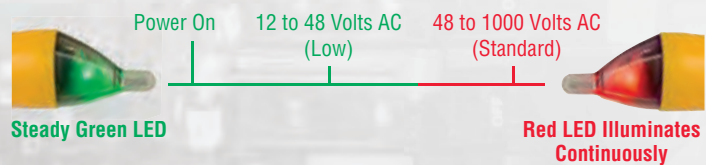

Audible Indicator



Power On	12 to 48 Volts AC (Low)	48 to 1000 Volts AC (Standard)
Beep	No Sound	High-Pitched Continuous Beeping Sound



Bright red LED indicates presence of voltage

Cat. No.	Batteries	Length (mm)	Width (mm)	Height (mm)	Weight (g)
NCVT-1	2 x AAA	140	18	25	46

NCVT-3

Non-Contact Voltage Tester with Flashlight

Features











- The NCVT-3 provides non-contact detection of AC voltage in cables, cords, circuit breakers, light fixtures, switches, outlets and wires as well as doorbells, thermostats, low voltage lighting and irrigation systems
- Convenient flashlight may be used independent of voltage detection function
- The visual indicator of the presence of voltage is an LED bar graph – the higher the voltage sensed, or the closer to the voltage source, the more LEDs light up
- Auto Power-Off conserves and extends battery life

**TOUGH
METER**



FEATURES

NCVT-1

 Durability	
 Drop Protection	2 m
 Ingress Protection	IP67
 Safety	CAT IV 1000V
 AC Voltage Range (Volts)	12 - 1000V
 DC Voltage (Volts)	—
 Visual Indicator	•
 Audible Indicator	•
 Worklight	•
 Auto-Power Off	•



Bright LED flashlight illuminates work area

LED Bar Graph Visual Indicator

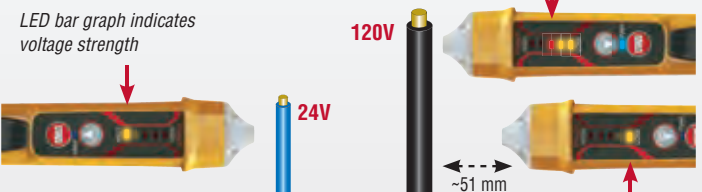

Audible Indicator



Audible voltage indicator beeps at a greater frequency the higher the voltage that is sensed, or the closer it gets to the voltage source.

Cat. No.	Batteries	Length (mm)	Width (mm)	Height (mm)	Weight (g)
NCVT-3	2 x AAA	148	24	29	72

IR1000

12:1 Single Laser Infrared Thermometer

FEATURES	IR1000
Drop Protection	—
Ingress Protection	—
Laser Targeting	Single Laser
Temperature Range	-50 – 538°C -58 – 1000°F
K-Type Thermocouple Range	—
Emissivity	0.95
Max / Min / Avg / Differential	●
High / Low Alarms	●
Backlight	●
Worklight	—
Auto-Power Off	●

Cat. No.	Length (mm)	Width (mm)	Height (mm)	Weight (g)
IR1000	44	83	178	111



CE

12:1 Distance To Spot Ratio for Accurate Temperature Readings:

If you are 3.7 meters away from an air vent, the vent should be 305 mm or less in diameter in order to attain the most accurate temperature measurement.

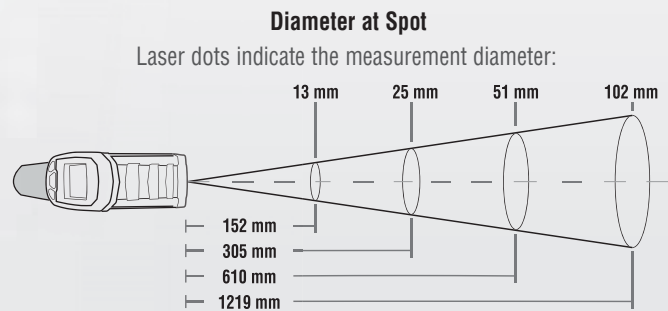

IR2000A

12:1 Dual Laser Infrared Thermometer

TOUGH METER

FEATURES	IR2000A
Drop Protection	2 m
Ingress Protection	—
Laser Targeting	Dual Laser
Temperature Range	-60 – 550°C -76 – 1022°F
K-Type Thermocouple Range	-64 – 1400°C -83.2 – 2552°F
Emissivity	0.10 – 1.00
Max / Min / Avg / Differential	●
High / Low Alarms	●
Backlight	●
Worklight	●
Auto-Power Off	●

Cat. No.	Length (mm)	Width (mm)	Height (mm)	Weight (g)
IR2000A	44	119	172	255

Dual Laser targeting
Work Light for dim workspaces

2 m drop protection
K-Type thermocouple
Backlit Display



CE

12:1 Distance To Spot Ratio for Accurate Temperature Readings:

If you are 3.7 meters away from an air vent, the vent should be 305 mm or less in diameter in order to attain the most accurate temperature measurement.

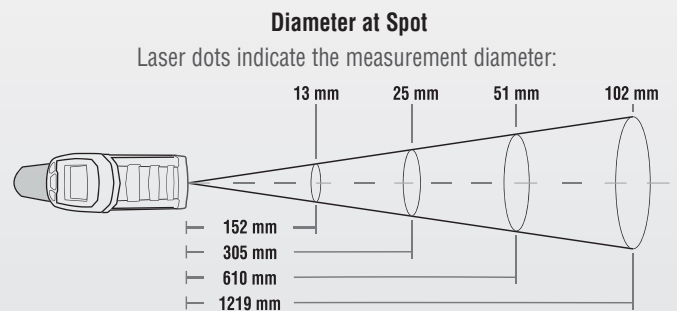



Test & Measurement Range

Designed by Electricians for Electricians



• MULTIMETERS • CLAMP METERS • ELECTRICAL TESTERS •

KLEIN TOOLS
For Professionals... Since 1857™



P.O. Box 126, Lonsdale SA 5160
T: +61 8 8186 0000 F: +61 8 8186 2222
www.kleintools.com.au

Find us here



MUMME TOOLS