

Cobalt Solar
EXCLUSIVE

CABLE GLANDS & CONDUIT FITTINGS



COBALTSOLAR
ENERGY

Leaders in Solar Component
Design and Manufacture

1300 273 111 | www.cobaltsolar.com.au

EXTENSIVE RANGE

Cobalt Solar provides an extensive range of glands, conduit fittings and accessories to suit a wide range of solar installations and applications. These are highly engineered products and meet or exceed Australian Standards. We can also custom design products for specific purposes.

END OF CONDUIT GLANDS

This Gland fits directly to the end of corrugated conduit with no need for any glue or adaptors offering far higher protection against moisture ingress.

- Part number beginning with CSE-ECG...

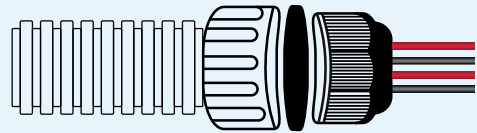

[More details on Page 4](#)

CONDUIT HEAD GLANDS

This gland provides an IP68 seal around cables with the added benefit of being able to fix corrugated conduit over the cables and lock it into place.

- Part number beginning with CSE-CHG...

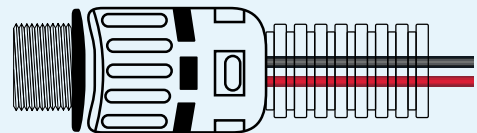

[More details on Page 8](#)

STANDARD MULTI-HOLE GLANDS

Designed to be inserted into an enclosure threaded entry or knock out (with optional lock nut.) For applications where the cables DO NOT require mechanical protection.

- Part number beginning with CSE-MG...

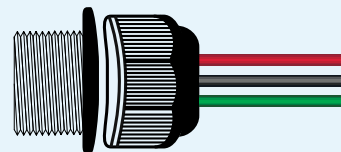

[More details on Page 11](#)

GLUE-LESS CONDUIT FITTINGS

Designed for corrugated conduit entries to enclosures providing IP66 seal.

- No special tools, glue or solvents required
- Quick and easy installation

- Part number beginning with CSE-WTF...

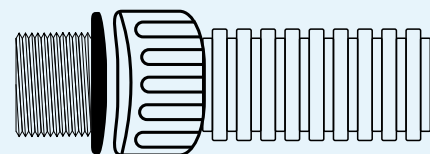

[More details on Page 14](#)

GLAND ACCESSORIES

Blanking plugs suitable for sealing additional holes in multi-hole glands are good to keep on hand. Anything not in our range of glands and conduit fittings can be requested. Please call **1300 273 111**

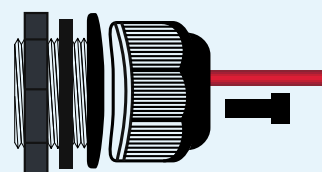

[More details on Page 17](#)

DESIGNED TO LAST

Cobalt Quality in Every Detail



Self-extinguishing, high-quality, flame-retardant material offering superior protection against flame propagation.



Extremely high resistance to weathering from oxidation. Over time, oxidation is the process that leads to cracking and hardening of inferior rubber seals.

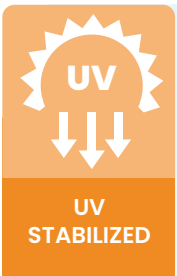

Our products spend a lot of time under the sun so Cobalt Solar uses cutting-edge materials science to produce the highest level of UV stabilisation available.

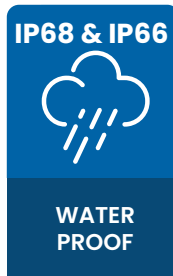

Ingress Protection rating offers a high level of defence against moisture ingress from driving rain, wash down and even full immersion.

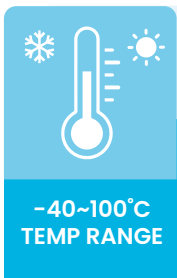

From alpine to desert, these products will stand the test of time.

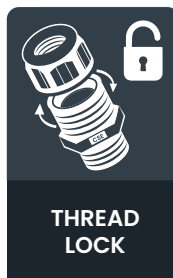

Present on all Cobalt Solar Glands, thread lock latches gland heads in place preventing loosening over time from vibration, expansion and contraction.



Designed from the ground up with PV in mind, our range of solar glands are specifically suited to the modern solar PV industry and meet local standards and requirements.



Our engineers strive to produce glands that are quick and easy to install with incredible reliability and a lower part count.

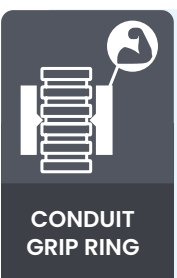

Developed by Cobalt Solar to mechanically lock into corrugated conduit to offer superior protection from pull out and increased weatherability



Cobalt Solar have been Australia's leading innovator of solar & electrical components since 2008. We produce an extensive range of unique products to effectively service a wide field of applications.

END OF CONDUIT GLANDS

Product

Fits directly to the end of corrugated conduit, eliminating glue and adaptors. Without the join between Multi-Hole Gland and adaptor, Our End of Conduit Glands have far higher protection against moisture ingress.

- Quick fit push-on design
- No tool, glue or pre-assembly required
- Superior weather protection
- Single part seamless solution

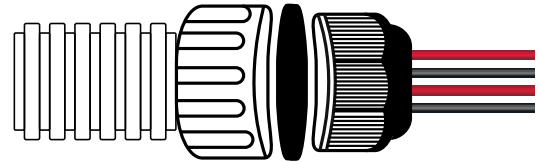

1. INSERT CABLES THROUGH GLAND

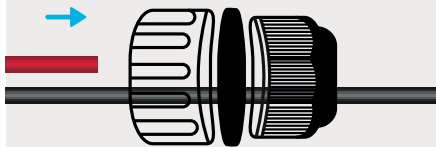

2. PUSH GLAND ONTO CONDUIT

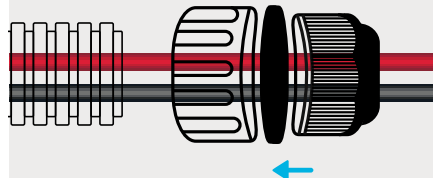

3. TIGHTEN GLAND AND CONDUIT HEADS

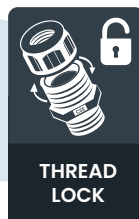
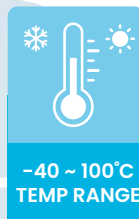
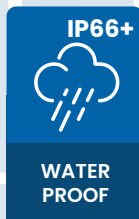
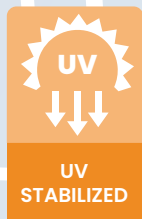
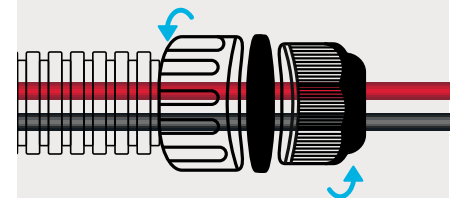

25mm END OF CONDUIT GLANDS

Available sizes

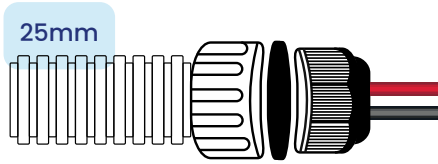

25mm

CABLE RANGE	PART NO.
-------------	----------

S 2 x 3.5 ~ 5.5 mm	CSE-ECG25-H2-5.5
L 2 x 5 ~ 7 mm	CSE-ECG25-H2-07

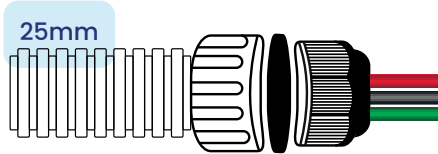

25mm

S 3 x 3.5 ~ 5.5 mm	CSE-ECG25-H3-5.5
L 3 x 5 ~ 7 mm	CSE-ECG25-H3-07
XL 3 x 6 ~ 8 mm	CSE-ECG25-H3-08

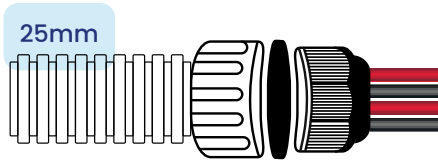

25mm

S 4 x 3 ~ 5 mm	CSE-ECG25-H4-05
L 4 x 5 ~ 7 mm	CSE-ECG25-H4-07

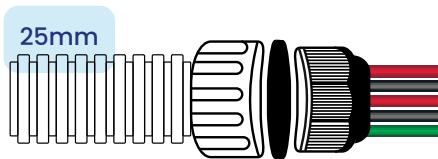

25mm

S 5 x 3 ~ 5 mm	CSE-ECG25-H5-05
M 5 x 5 ~ 7 mm	CSE-ECG25-H5-06

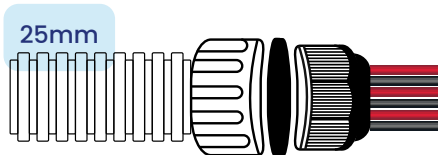

25mm

S 6 x 3 ~ 5 mm	CSE-ECG25-H6-05
-----------------------	-----------------

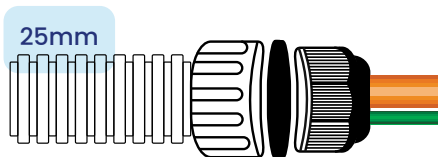

25mm

S 9 ~ 12 mm + 3.5 ~ 4.8 mm	CSE-ECG25-H2-4.8-11
L 10 ~ 12.5 mm + 3.5 ~ 4.8 mm	CSE-ECG25-H2-4.8-12.5

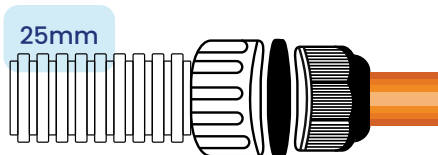

25mm

S 10 ~ 13 mm	CSE-ECG25-H1-13
L 12 ~ 16 mm	CSE-ECG25-H1-16

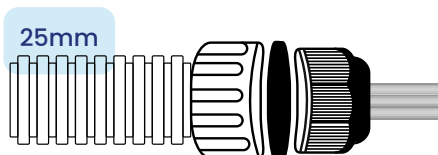

25mm





L TPS or Flat 2C&E 2.5 ~ 6mm ² *	CSE-ECG25-0614
--	----------------

* Dust seal only on TPS, cable range guide only

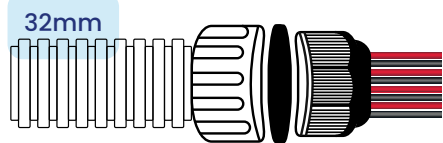
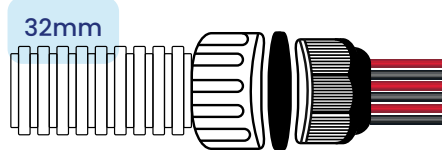
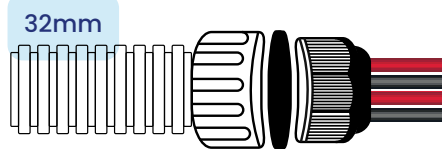
32mm END OF CONDUIT GLANDS

Available sizes



CABLE RANGE	PART NO.
 S 4 x 3 ~ 5 mm	CSE-ECG32-H4-05
 L 4 x 5 ~ 7 mm	CSE-ECG32-H4-07
 S 6 x 3.5 ~ 5.5 mm	CSE-ECG32-H6-5.5
 L 6 x 5 ~ 7 mm	CSE-ECG32-H6-07
 S 8 x 3.5 ~ 5.5 mm	CSE-ECG32-H8-5.5



END OF CONDUIT GLANDS

Data Sheet

End of Conduit Glands		
PART NUMBER	CSE-ECG25-...	CSE-ECG32-...
TO SUIT	CORRUGATED CONDUIT	
SIZE CONDUIT SUIT	25MM	32MM
GLAND HEAD SIZE	25MM	32MM
COLOUR	BLACK	
IP RATING	IP66 & IP68	
FIRE RATING	V2	
TEMPERATURE RANGE	-40 TO +100°C	
UV PROTECTION	HIGH	
WARRANTY	10 YEARS	
REPLACEMENT SCHEDULE	AT 15 YEARS	
BODY MATERIAL	HIGH UV NYLON	
SEAL MATERIAL	EPDM RUBBER	
CONDUIT GRIP RING	YES	
LOCKING GLAND HEAD	YES	
SEALANT REQUIRED	NO	
CUSTOM SIZES AVAILABLE	YES	
CHEMICAL RESISTANCE	SALT, WEAK ACID, ALCOHOL, OIL, GREASE & SOME SOLVENTS	
DIMENSIONS ABOVE ROOF SURFACE (D : H)	40MM : 65MM	45MM : 65MM

NOTES

CONDUIT HEAD GLANDS

Product

Engineered by Cobalt Solar providing an IP68 seal to the cables, fixing the corrugated conduit over the cables and lock it into place in one part.

Without any glue or adaptors, providing permanent, tidy mechanical protection. This allows for multiple cables in one entry, with an open-ended conduit. Also used as a replacement to conduit fittings so that enclosures and equipment do not have to rely on the integrity and watertightness of connecting conduits.

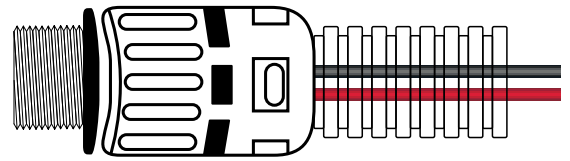

- Improved installation reliability
- Open-ended conduits now an option
- Enclosures isolated from conduit leaks
- Neat and permanent mechanical protection

1. THREAD GLAND INTO ENCLOSURE OR USE LOCKING NUT

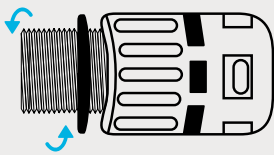

2. INSERT CABLES THROUGH GLAND & TIGHTEN

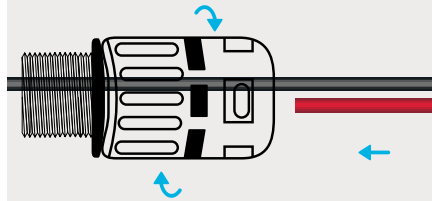

3. PUSH CONDUIT INTO CONDUIT HEAD

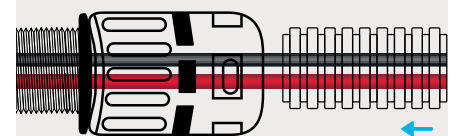

Note:

- Conduit cannot be released
- Do Not Glue

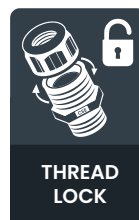
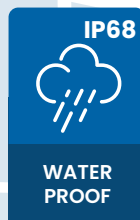
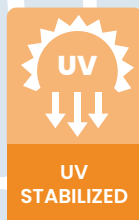

25mm CONDUIT HEAD GLANDS

Available sizes

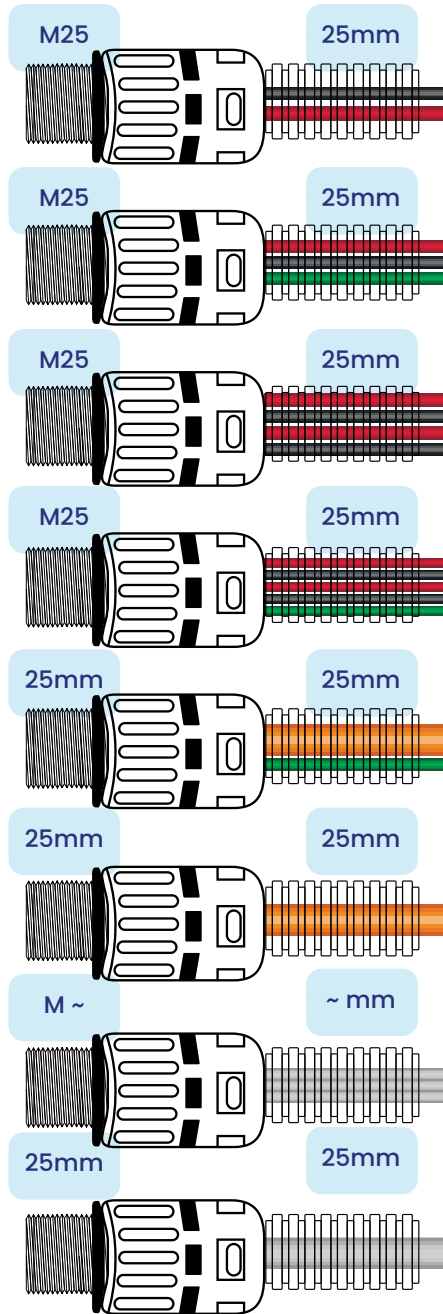

CABLE RANGE	PART NO.
S 2 x 3.5 ~ 5.5 mm	CSE-CHG25-H2-5.5
L 2 x 5 ~ 7 mm	CSE-CHG25-H2-07
S 3 x 3.5 ~ 5.5 mm	CSE-CHG25-H3-5.5
S 4 x 3 ~ 5 mm	CSE-CHG25-H4-05
L 4 x 5 ~ 7 mm	CSE-CHG25-H4-07
S 5 x 3 ~ 5 mm	CSE-CHG25-H5-05
S 9 ~ 11 mm + 3.5 ~ 4.8 mm	CSE-CHG25-H2-4.8-11
L 10 ~ 12.5 mm + 3.5 ~ 4.8 mm	CSE-CHG25-H2-4.8-12.5
L 1 x 12 ~ 16 mm	CSE-CHG25-H1-16
L TPS or Flat 2C&E 2.5 ~ 6mm*	CSE-CHG25-0614
<small>* Dust seal only on TPS, cable range guide only</small>	
REQUEST	CUSTOM MODELS

CONDUIT HEAD GLANDS

Data Sheet

Conduit Head Glands		
PART NUMBER	CSE-CHG25-...	CSE-ITF-...
TO SUIT	CORRUGATED CONDUIT	
SIZE CONDUIT SUIT	25MM	
GLAND HEAD SIZE	25MM	
COLOUR	BLACK	
IP RATING (CABLE/S SEAL)	IP66 & IP68	
IP RATING (CONNECTION TO CONDUIT)	IP40	
FIRE RATING (UL 94)	V2	
CRUSH RESISTANCE	HD	
TEMPERATURE RANGE	-40 TO +100°C	
UV PROTECTION	HIGH	
WARRANTY	10 YEARS	
REPLACEMENT SCHEDULE	AT 15 YEARS	
BODY MATERIAL	HIGH UV NYLON	
SEAL MATERIAL	EPDM RUBBER	
CONDUIT GRIP RING	YES	
LOCKING GLAND HEAD	YES	
SEALANT REQUIRED	NO	
CUSTOM SIZES AVAILABLE	YES	
CHEMICAL RESISTANCE	SALT, WEAK ACID, ALCOHOL, OIL, GREASE & SOME SOLVENTS	
DIMENSIONS ABOVE ROOF SURFACE (D : H)	35MM : 77MM	

Important note: Conduit connection is NOT water tight. This product seals to the cables ONLY.

NOTES

STANDARD MULTI-HOLE GLANDS

Product

Designed to be inserted into an enclosure threaded entry or knock out (with optional lock nut.) For applications where the cables DO NOT require mechanical protection. For applications requiring mechanical protection see "Conduit Head Glands" or "End of Conduit Glands".

- Superior quality design and materials
- Like-for-like upgrade
- Extensive range of sizes
- Fit for purpose hole sizing

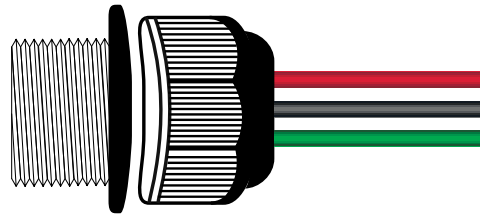

1. THREAD GLAND INTO ENCLOSURE OR USE LOCKING NUT

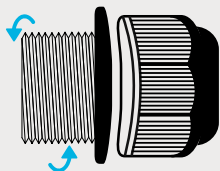

2. INSERT CABLES THROUGH GLAND

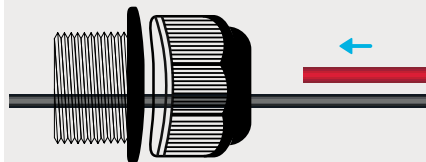



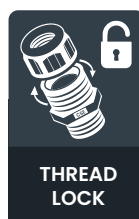
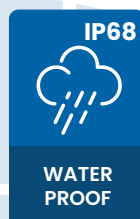
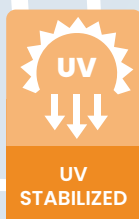
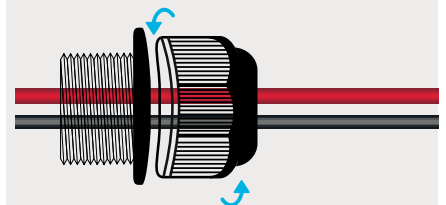







3. TIGHTEN



STANDARD MULTI-HOLE GLANDS

Available sizes

	CABLE RANGE	PART NO.
M25	 S 2 x 3.5 ~ 5.5 mm	CSE-MG25-H2-5.5
	 L 2 x 5 ~ 7 mm	CSE-MG25-H2-07
M25	 S 3 x 3.5 ~ 5.5 mm	CSE-MG25-H3-5.5
	 L 3 x 5 ~ 7 mm	CSE-MG25-H3-07
M25	 S 4 x 3 ~ 5 mm	CSE-MG25-H4-05
	 L 4 x 5 ~ 7 mm	CSE-MG25-H4-07
M25	 S 5 x 3 ~ 5 mm	CSE-MG25-H5-05
	 M 5 x 4 ~ 6 mm	CSE-MG25-H5-06
M25	 S 6 x 3 ~ 5 mm	CSE-MG25-H6-05
M25	 ~ Water Jet or On site Cut	CSE-CSE-MG25A-H0-00B
M32	 L 6 x 5 ~ 7 mm	CSE-MG32A-H6-07B

STANDARD MULTI-HOLE GLANDS

Data Sheet

Standard Multi-Hole Glands		
PART NUMBER	CSE-MG25-...	CSE-MG32-...
SUITS THREAD SIZE	M25	M32
GLAND HEAD SIZE	25MM	32MM
COLOUR	BLACK	
IP RATING	IP66 & IP68	
FIRE RATING (UL 94)	V2	
CRUSH RESISTANCE	HD	
TEMPERATURE RANGE	-40 TO +100°C	
UV PROTECTION	HIGH	
WARRANTY	10 YEARS	
REPLACEMENT SCHEDULE	AT 15 YEARS	
BODY MATERIAL	HIGH UV NYLON	
SEAL MATERIAL	EPDM RUBBER	
LOCKING GLAND HEAD	YES	
SEALANT REQUIRED	NO	
CUSTOM SIZES AVAILABLE	YES	
CHEMICAL RESISTANCE	SALT, WEAK ACID, ALCOHOL, OIL, GREASE & SOME SOLVENTS	
DIMENSIONS ABOVE ROOF SURFACE (D : H)	40MM : 50MM	45MM : 55MM

NOTES

GLUE-LESS CONDUIT FITTINGS

Product

Designed for corrugated conduit entries to enclosures providing an IP66 seal. Cobalt Solar Glue-less conduit fittings are simple to use and a must for all installers looking to improve system quality and install time. Give them a try you won't be disappointed.

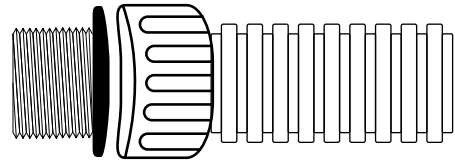

- Can be installed, uninstalled and reinstalled with ease
- Superior aesthetics
- Conduit grip ring

1. THREAD FITTING INTO ENCLOSURE OR USE LOCKING NUT

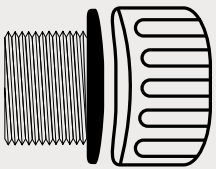

2. INSERT CABLES THROUGH FITTING

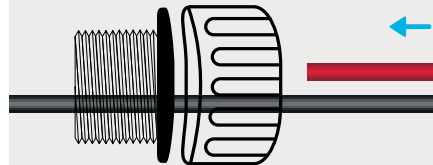

3. PUSH IN CONDUIT AND TIGHTEN

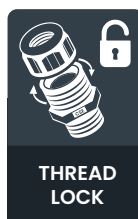
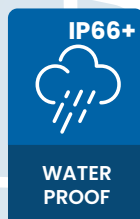
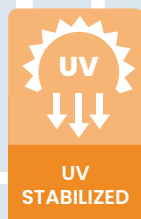
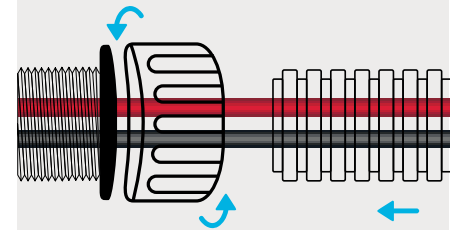

GLUE-LESS CONDUIT FITTINGS

Available sizes

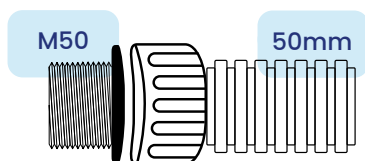
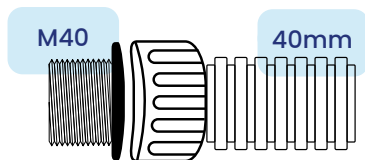
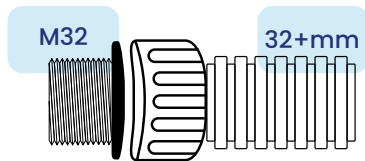
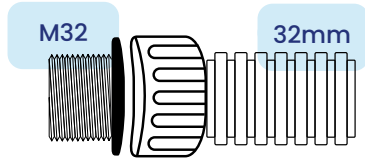
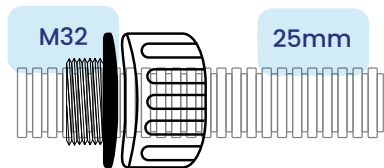
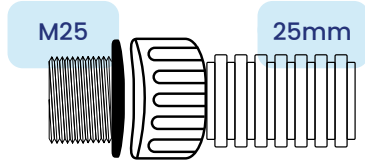
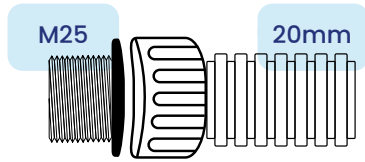
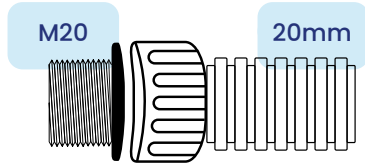

CONDUIT SIZE	PART NO.
 M20 Thread - 20mm Conduit	CSE-WTF-M20-21.2
 M25 Thread - 20mm Conduit	CSE-WTF-M25-21.2
 M25 Thread - 25mm Conduit	CSE-WTF-M25-25.0
 M32 Thread - 25mm Conduit	CSE-WTF-M32-25.0-E
 M32 Thread - 32mm Conduit	CSE-WTF-M32-32.0
 M32 Thread - 32-34.5mm Conduit	CSE-WTF-M32-34.5
 M40 Thread - 40mm Conduit	CSE-WTF-M40-42.5
 M50 Thread - 50mm Conduit	CSE-WTF-M50-54.5

GLUE-LESS CONDUIT FITTINGS

Data Sheet

GLUE-LESS CONDUIT FITTINGS	
PART NUMBER	CSE-WTF-...
TO SUIT	CORRUGATED CONDUIT
SUITS CONDUIT SIZE	20MM - 50MM
SUITS THREAD SIZE	M20 - M50
COLOUR	BLACK
IP RATING (CABLE/S SEAL)	IP66 & IP67
FIRE RATING (UL 94)	V2
CRUSH RESISTANCE	HD
TEMPERATURE RANGE	-40 TO +100°C
UV PROTECTION	HIGH
WARRANTY	10 YEARS
REPLACEMENT SCHEDULE	AT 15 YEARS
BODY MATERIAL	HIGH UV NYLON
SEAL MATERIAL	EPDM RUBBER
CONDUIT GRIP RING	YES
LOCKING GLAND HEAD	YES
SEALANT REQUIRED	NO
CUSTOM SIZES AVAILABLE	YES
LOCKING NUT INCLUDED	NO (CAN BE SUPPLIED SEPERATELY, OFTEN AT NO COST)
CHEMICAL RESISTANCE	SALT, WEAK ACID, ALCOHOL, OIL, GREASE & SOME SOLVENTS

NOTES

GLAND ACCESSORIES

Product

To reduce cost, environmental impact and waste, most Cobalt Solar glands and conduit fittings come WITHOUT locking nuts but with EPDM sealing washers. Lock nuts can be purchased separately. Often at no cost.

Blanking plugs are suitable for sealing additional holes in multi-hole glands, good to keep on hand. Anything not in our range of glands and conduit fittings can be requested. Please call 1300 273 111

- Additional products available upon request
- Customization available

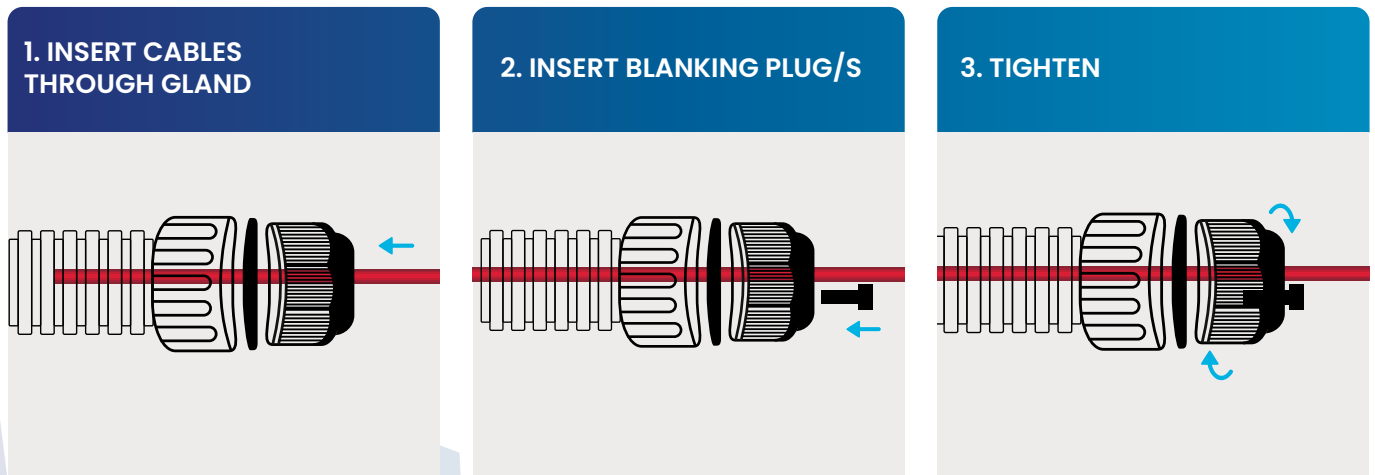
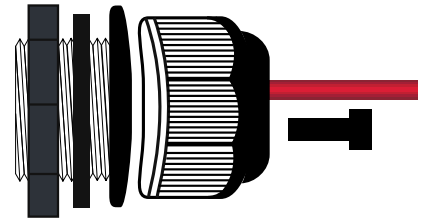



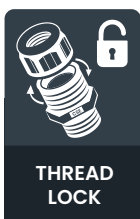
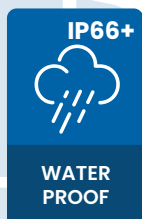
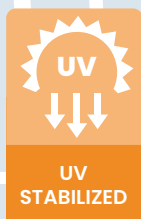



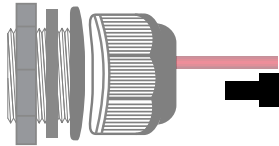
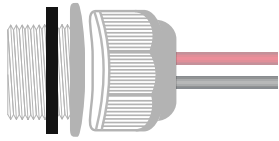
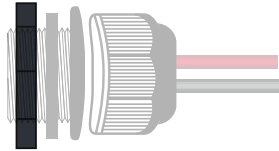

Note: Install steps for CSE-WTF-T... Please see page 14



GLAND ACCESSORIES

Available sizes



DESCRIPTION	PART NO.
 S Suit M20 Thread	CSE-LN-M20A
 M Suit M25 Thread	CSE-LN-M25A
 L Suit M32 Thread	CSE-LN-M32A
 S Suit M20 Thread	CSE-WA-M20A
 L Suit M25 Thread	CSE-WA-M25A
 S Replace 1 x 3.5 ~ 6 mm	CSE-SPM-050-B
 L Replace 1 x 5 ~ 8 mm	CSE-SPM-070-B

M32

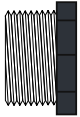

M25

 M32 Male - M25 Female Reducer	CSE-M32-M25
---	-------------

M25

M25

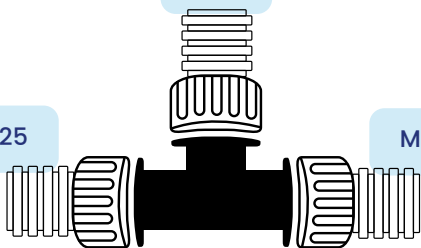

M25

 25mm Glue-less Conduit T	CSE-WTF-T-25
--	--------------

ACCESSORIES

Data Sheet

Glue-less Conduit T	
PART NUMBER	CSE-WTF-T-...
TO SUIT	CORRUGATED CONDUIT
SUITS CONDUIT SIZE	20MM - 50MM
COLOUR	BLACK
IP RATING (CABLE/S SEAL)	IP66 & IP67
FIRE RATING (UL 94)	V2
CRUSH RESISTANCE	HD
TEMPERATURE RANGE	-40 TO +100°C
UV PROTECTION	HIGH
WARRANTY	10 YEARS
REPLACEMENT SCHEDULE	AT 15 YEARS
BODY MATERIAL	HIGH UV NYLON
SEAL MATERIAL	EPDM RUBBER
CONDUIT GRIP RING	YES
LOCKING GLAND HEAD	YES
SEALANT REQUIRED	NO
CUSTOM SIZES AVAILABLE	YES
CHEMICAL RESISTANCE	SALT, WEAK ACID, ALCOHOL, OIL, GREASE & SOME SOLVENTS

NOTES

Leaders in Solar Component Design and Manufacture



COBALTSOLAR
ENERGY

1300 273 111

www.cobaltsolar.com.au