

## Miniature circuit breakers

### Din-Safe single pole width residual current circuit breaker (RCBO)

- Standards AS/NZS 61009
- Approval N17482
- One module wide (18 mm)
- Short circuit, overcurrent and earth leakage protection
- Short circuit protection 10 kA
- Sensitivity 10 and 30 mA
- Din rail mount
- Suits CD chassis
- Type "A" residual current device (AC/DC)



Amp rating (A)	Modules (18mm)	Voltage (AC)	Short circuit (kA)	Trip Sensitivity (mA)	Cat. No <sup>1)</sup> <sup>2)</sup>
6	1	240	10	30	DSRCBH0630A
10	1	240	10	30	DSRCBH1030A
16	1	240	10	30	DSRCBH1630A
20	1	240	10	30	DSRCBH2030A
25	1	240	10	30	DSRCBH2530A
32	1	240	10	30	DSRCBH3230A
40	1	240	10	30	DSRCBH4030A
6	1	240	10	10	<i>i</i> DSRCBH0610A
10	1	240	10	10	DSRCBH1010A
16	1	240	10	10	DSRCBH1610A
20	1	240	10	10	DSRCBH2010A
25	1	240	10	10	<i>i</i> DSRCBH2510A
32	1	240	10	10	<i>i</i> DSRCBH3210A
40	1	240	10	10	<i>i</i> DSRCBH4010A

**Note:** <sup>1)</sup> Neutral not switched.  
<sup>2)</sup> Will not accept side mounting accessories.  
*i* Available on indent only.

#### Operation

This unit combines the overload and short circuit protection of an MCB with earth leakage protection of an RCD. The unit occupies one, sub- circuit (one pole) of the distribution board and provides single phase protection against overload, short circuit and earth leakage current.

- The MCB element provides thermal and magnetic tripping protection which is rated to 10 kA prospective fault current.
- The RCD element of the device provides core-balance detection of the difference between the active and neutral currents and amplification to provide high sensitivity. The rated residual operating current ( $I_{\Delta n}$ ) is 10 mA or 30 mA.
- The green/yellow earth reference cable, in case of loss of supply neutral, ensures the device will continue to provide earth leakage protection and will operate normally upon detection of an earth leakage current.

#### Dimensions (mm)

**Note:** A 1.2 m long pigtail lead is included as standard.

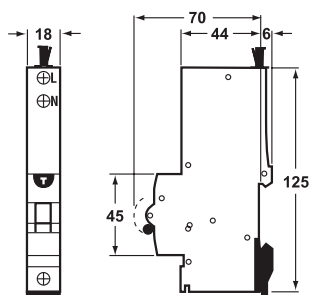

#### Application

The Din-Safe single pole width residual current circuit breaker will fit the standard Din-T chassis for use in NHP panelboards. The design makes it possible to provide an MCB complete with earth leakage protection in an 18 mm wide module, which allows a greater number of devices to be fitted into a distribution board.

#### Connection diagram

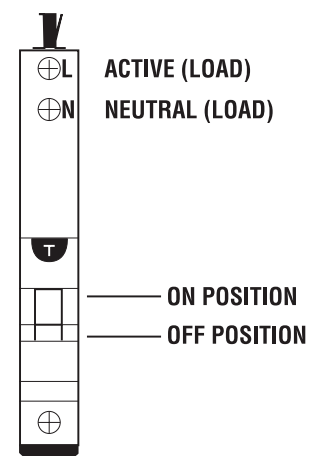

**Note:** Nuisance tripping may be experienced in VFD and motor starting applications refer NHP.

## Din-T MCBs + RCDs Technical data

### Tripping curves according to EN 60898

The following tables show the average tripping curves of the Terasaki Din-T MCBs based on the thermal and magnetic characteristics.

#### Curve C

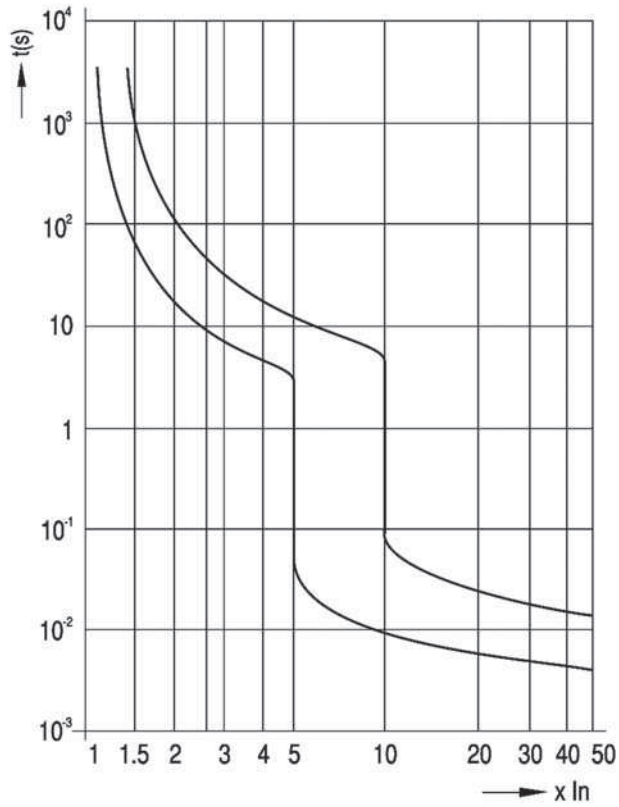

# Din-T MCBs + RCDs Technical data

## What is an RCD?

3

The RCD (Residual Current Device) is a device intended to protect people against indirect contact, the exposed conductive parts of the installation being connected to an appropriate earth electrode. It may be used to provide protection against fire hazards due to a persistent earth fault current, without operation of the overcurrent protective device.

RCDs having a rated residual operating current not exceeding 30 mA are also used as a means for additional protection in case of failure of the protective means against electric shock (direct contact).

### Working Principle

The main components of an RCD are the following:

- The core transformer: which detects the earth fault current.
- The relay: when an earth fault current is detected, the relay reacts by tripping and opening the contacts.
- The mechanism: element to open and close the contacts either manually or automatically.
- The contacts: to open or close the main circuit.

The RCD constantly monitors the vectorial sum of the current passing through all the conductors. In normal conditions the vectorial sum is zero ( $I_1+I_2=0$ ) but in case of an earth fault, the vectorial sum differs from zero ( $I_1+I_2=I_d$ ), this causes the actuation of the relay and therefore the release of the main contacts.

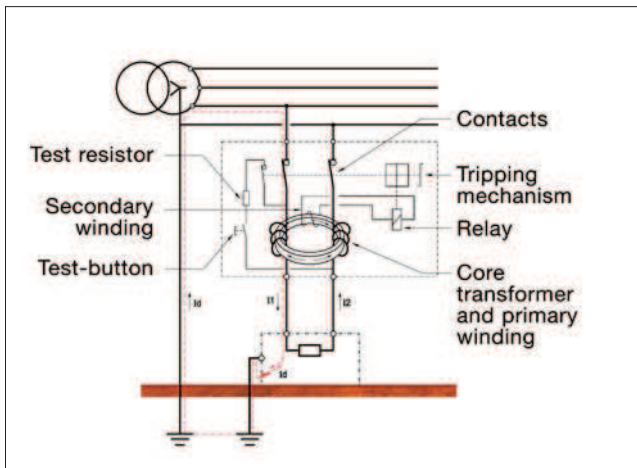

### Definitions related to RCDs

**RCCB = Residual Current Circuit Breaker without overcurrent protection.**

**RCBO = Residual Current Circuit Breaker with overcurrent protection.**

### Breaking capacity

A value of AC component of a prospective current that an RCCB is capable of breaking at a stated voltage under prescribed conditions of use and behaviour.

### Residual making and breaking capacity ( $I_{\Delta m}$ )

A value of the AC component of a residual prospective current which an RCCB can make, carry for its opening time and break under specified conditions of use and behaviour.

### Conditional residual short-circuit current ( $I_{\Delta c}$ )

A value of the AC component of a prospective current which an RCCB protected by a suitable SCPD (short-circuit protective device) in series, can withstand, under specific conditions of use and behaviour.

### Conditional short-circuit current ( $I_{nc}$ )

A value of the AC component of a residual prospective current which an RCCB protected by a suitable SCPD in series, can withstand, under specific conditions of use and behaviour.

### Residual short-circuit withstand current

Maximum value of the residual current for which the operation of the RCCB is ensured under specified conditions, and above which the device can undergo irreversible alterations.

### Prospective current

The current that would flow in the circuit, if each main current path of the RCCB and the overcurrent protective device (if any) were replaced by a conductor of negligible impedance.

### Making capacity

A value of AC component of a prospective current that an RCCB is capable to make at a stated voltage under prescribed conditions of use and behaviour.

### Open position

The position in which the predetermined clearance between open contacts in the main circuit of the RCCB is secured.

### Closed position

The position in which the predetermined continuity of the main circuit of the RCCB is secured.

### Tripping time

The time which elapses between the instant when the residual operating current is suddenly attained and the instant of arc extinction in all poles.

### Residual current ( $I_{\Delta n}$ )

Vector sum of the instantaneous values of the current flowing in the main circuit of the RCCB.

### Residual operating current

Value of residual current which causes the RCCB to operate under specified conditions.

### Rated short-circuit capacity ( $I_{cn}$ )

Is the value of the ultimate short-circuit breaking capacity assigned to the circuit breaker. (Only applicable to RCBO)

### Conventional non-tripping current ( $I_{nt}$ )

A specified value of current which the circuit breaker is capable of carrying for a specified time without tripping. (Only applicable to RCBO)

### Conventional tripping current ( $I_t$ )

A specified value of current which causes the circuit breaker to trip within a specified time. (Only applicable to RCBO)

# Din-T MCBs + RCDs Technical data

## RCDs classification according to EN 61008/61009

RCDs may be classified according to:

The behaviour in the presence of DC current  
(types for general use).

- Type AC
- Type A

The time-delay (in the presence of residual current)

- RCDs without time delay: type for general use
- RCDs with time delay: type S for selectivity

### Type AC <sup>1) 2)</sup>

The type AC RCDs are designed to release with sinusoidal residual currents which occur suddenly or slowly rise in magnitude.

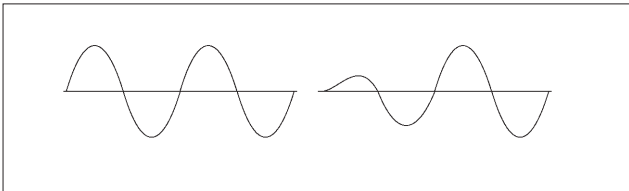

Residual current	Tripping time
0.5 x IΔn	t = ∞
1 x IΔn	t = <300 ms
2 x IΔn	t = <150 ms
5 x IΔn	t = ≤40 ms

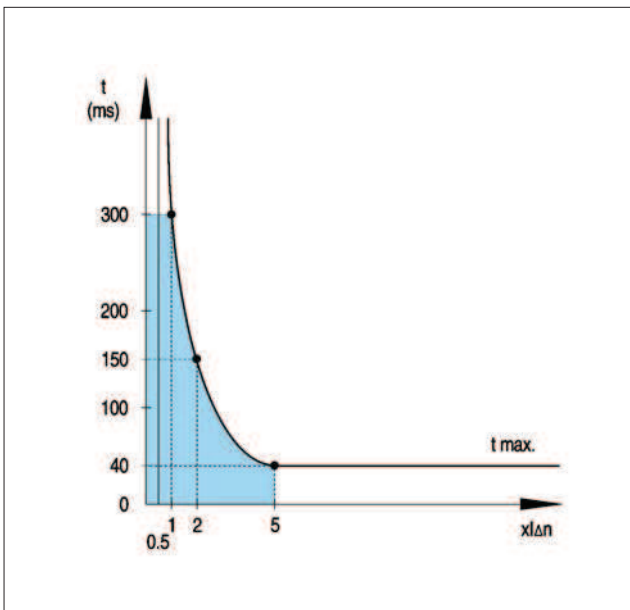

Tripping curve type AC

<sup>1)</sup> Standard in Australia

<sup>2)</sup> Type A acceptable in Australia

### Type A <sup>3) 4)</sup>

Certain devices during faults can be the source of non-sinusoidal earth leakage currents (DC components) due to the electronic components e.g. diodes, thyristors etc.

Type A RCDs are designed to ensure that under these conditions the residual current devices operate on sinusoidal residual current and also with pulsating direct current(\*) which occur suddenly or slowly rise in magnitude.

(\*) Pulsating direct current: current of pulsating wave form which assumes, in each period of the rated power frequency, the value 0 or a value not exceeding 0.006 A DC during one single interval of time, expressed in angular measure of at least 150°.

Residual current	Tripping time
1. For sinusoidal residual current	
0.5 x IΔn	t = ∞
1 x IΔn	t = <300 ms
2 x IΔn	t = <150 ms
5 x IΔn	t = ≤40 ms

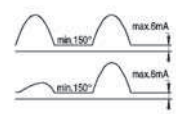
2. For residual pulsating direct current	
At point of wave 0°	
	
0.35 x IΔn	t = ∞
1.4 x IΔn	t = <300 ms
2.8 x IΔn	t = <150 ms
7 x IΔn	t = ≤40 ms

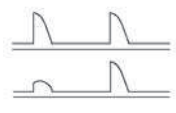
At point of wave 90°	
	
0.25 x IΔn	t = ∞
1.4 x IΔn	t = <300 ms
2.8 x IΔn	t = <150 ms
7 x IΔn	t = ≤40 ms

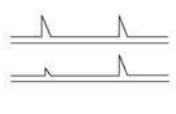
At point of wave 135°	
	
0.11 x IΔn	t = ∞
1.4 x IΔn	t = <300 ms
2.8 x IΔn	t = <150 ms
7 x IΔn	t = ≤40 ms

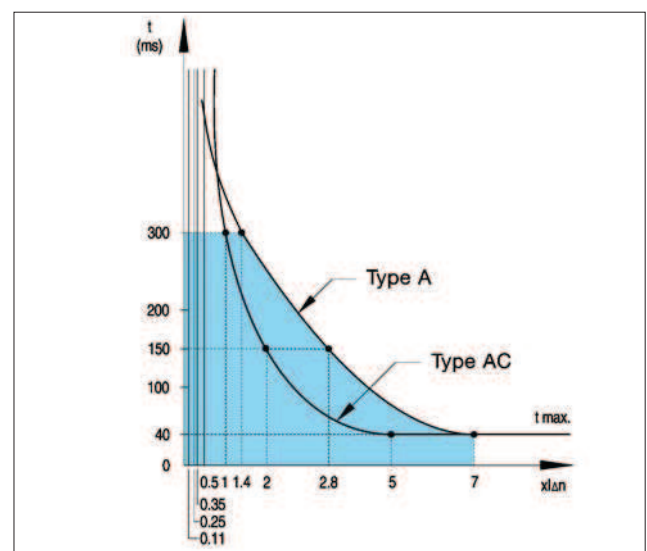

Tripping curve type A

<sup>3)</sup> Standard in New Zealand

<sup>4)</sup> DSRCBH is type A.

# Din-T MCBs + RCDs Technical data

## Nuisance tripping

All DinSafe RCDs have a high level of immunity to transient currents, against current impulses of 8/20  $\mu$ s according to EN 61008/61009 and VDE 0664.T1.

Type A, AC.....250 A 8/20  $\mu$ s

Type S.....3000 A 8/20  $\mu$ s

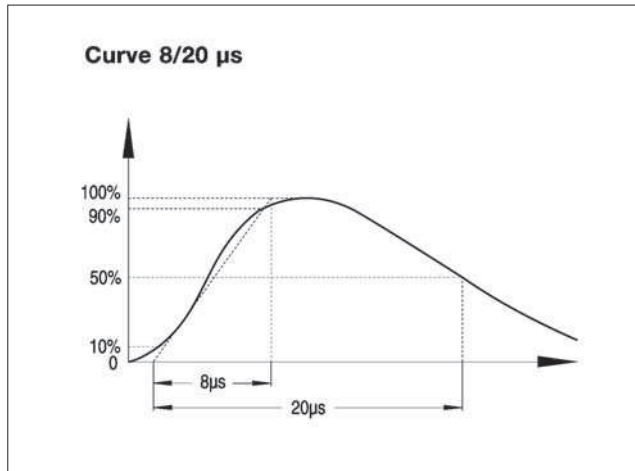

RCDs have a high level of immunity against alternating currents of high frequency according to EN 61008/61009.

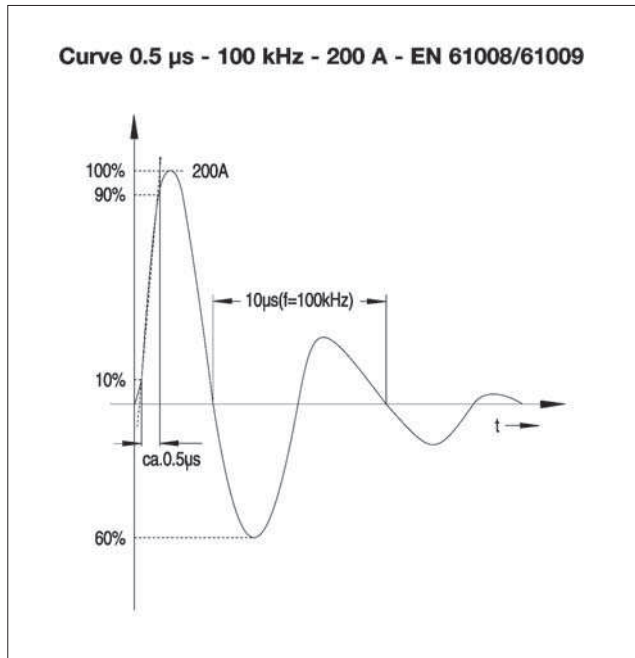

# Din-T MCBs + RCDs Technical data

## Use of an RCBO (DSRCBH)

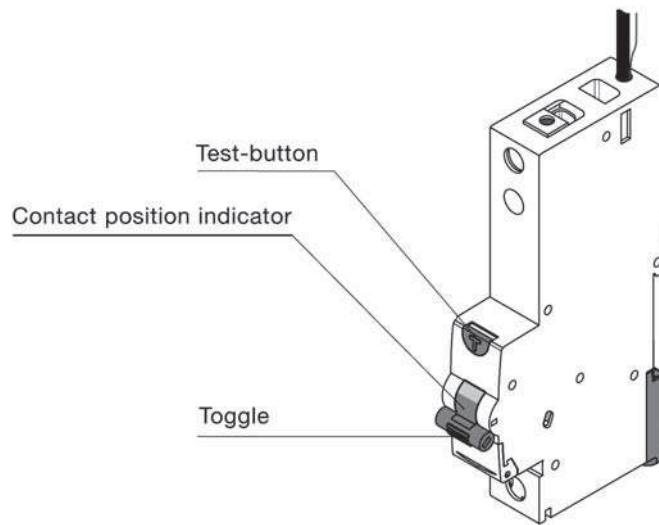

### TEST-BUTTON

To ensure the correct functioning of the RCBO, the test-button T shall be pressed frequently. The device must trip when the test-button is pressed.

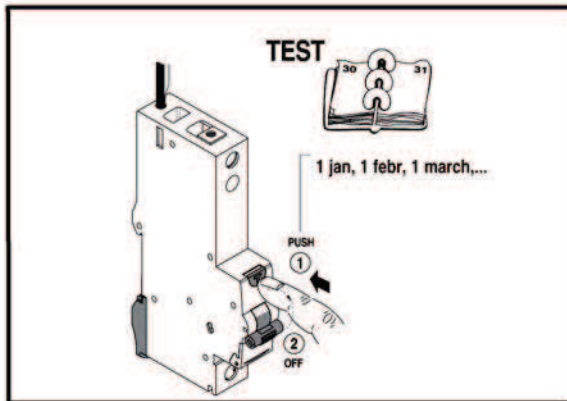

### CONTACT POSITION INDICATOR

Printing on the toggle to provide information of the real contact position.

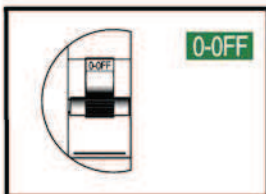

#### O-OFF

Contacts in open position. Ensure a distance between contacts > 4 mm.



#### I-ON

Contacts in closed position. Ensure continuity in the main circuit.

### TOGGLE

To manually switch the RCBO ON or OFF

### CABLE CONNECTION

The power supply (L) must be done at the bottom terminal, and the supply neutral flying cable (black) shall be connected to the neutral bar.

Load connection shall be done in both terminals at the top side (L out / N out).

The earth reference cable (FE white) ensures protection against earth leakage in case of loss of supply neutral.

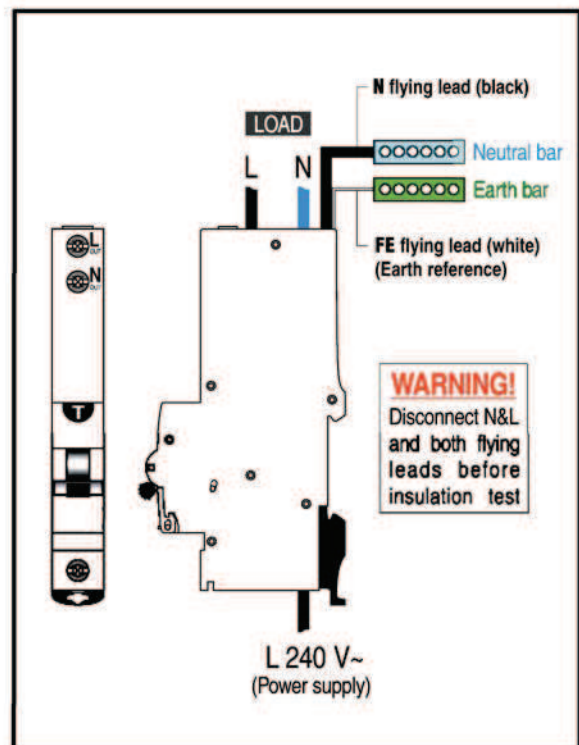

## Din-T MCBs + RCDs Technical data

### Product related information

#### Influence of temperature on RCBOs (DinSafe DSRCB)

The thermal calibration of the RCBO was carried out at an ambient temperature of 30 °C. Ambient temperatures different from 30 °C influence the bimetal and this results in earlier or later thermal tripping.

3

**0.5 - 6 A**

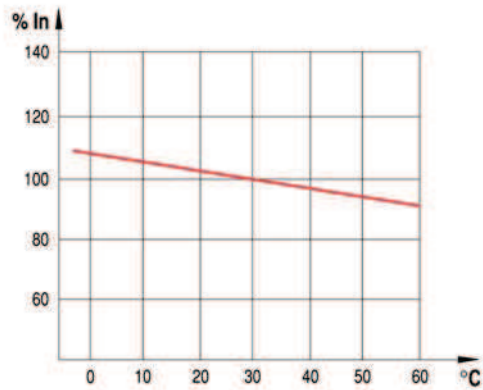

**10 A**

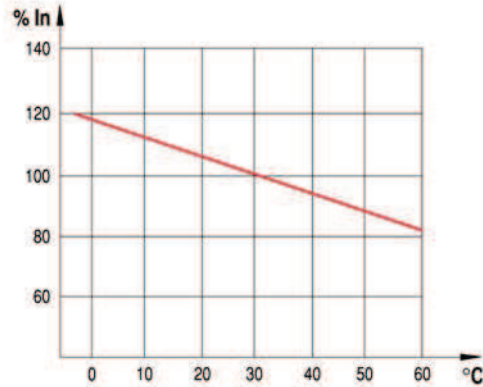

**16 - 40 A**

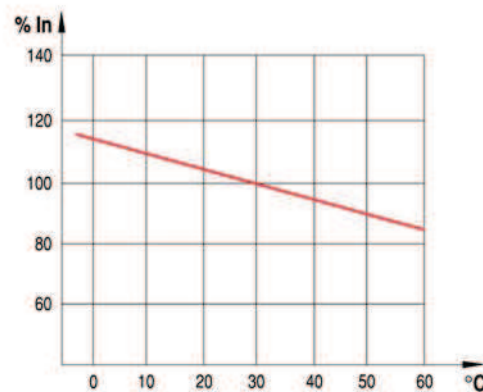

## Din-T MCBs + RCDs Technical data

### Tripping current as a function of the frequency

All RCDs are designed to work at frequencies of 50-60 Hz, therefore to work at different values, we must consider the variation of the tripping sensitivity according to the tables below. It should be taken into consideration that there is a no tripping risk when pushing the test-button, due to the fact that such action is made by means of an internal resistor with a fixed value.

#### RCBO DSRCBH <sup>3)</sup>

Type AC <sup>1)</sup>	10 Hz	30 Hz	50 Hz	100 Hz	200 Hz	300 Hz	400 Hz
30 mA	0.62	0.65	0.80	0.91	1.24	1.55	1.88
100 mA	0.74	0.71	0.80	0.95	1.16	1.38	1.59
300 mA	0.80	0.74	0.80	0.97	1.19	1.44	1.64
500 mA	1.10	0.81	0.80	0.89	1.18	1.38	1.68
Type A <sup>2)</sup>							
30 mA	8.17	3.13	0.75	1.70	3.10	3.52	3.67
100 mA	6.81	2.71	0.75	1.43	2.35	2.58	2.71
300 mA	6.20	2.16	0.75	0.49	0.87	0.74	0.95
500 mA	4.34	1.53	0.75	0.39	0.59	0.62	0.64

**Notes:** <sup>1)</sup> The standard NHP/Terasaki type is the "type AC" in Australia, Type "A" in New Zealand.

<sup>2)</sup> The standard NHP/Terasaki DSRCBH single pole RCBO is "type A" in Australia and New Zealand.

<sup>3)</sup> The numbers in the table above are multipliers, e.g. A "DSRCD" at 50 hz has an 0.8 multiplier.  
Therefore a 30 mA, "type AC" RCD will trip at (0.8 x 30 mA) 24 mA.

### Power losses

The power losses are calculated by means of measuring the voltage drop between the incoming and the outgoing terminal of the device at rated current. Power loss per pole:

#### RCBO-Single pole DSRCBH

In (A)	6	10	13	16	20	25	32	40	50	63
Z (mOhm)	45.8	16.4	12.5	10.6	7.3	5.4	3.2	2.6	1.9	1.4
Pw (W)	1.65	1.7	2.1	2.7	2.9	3.3	3.4	4.2	4.8	5.6



## Din-T MCBs + RCDs Technical data

### RCBO (DSRCB) let-through energy $I^2t$

The benefit of an RCBO in short-circuit conditions, is its ability to reduce the value of the let-through energy that the short-circuit would be generating.

#### Din-T single pole width RCD (DSRCBH)

Curve C

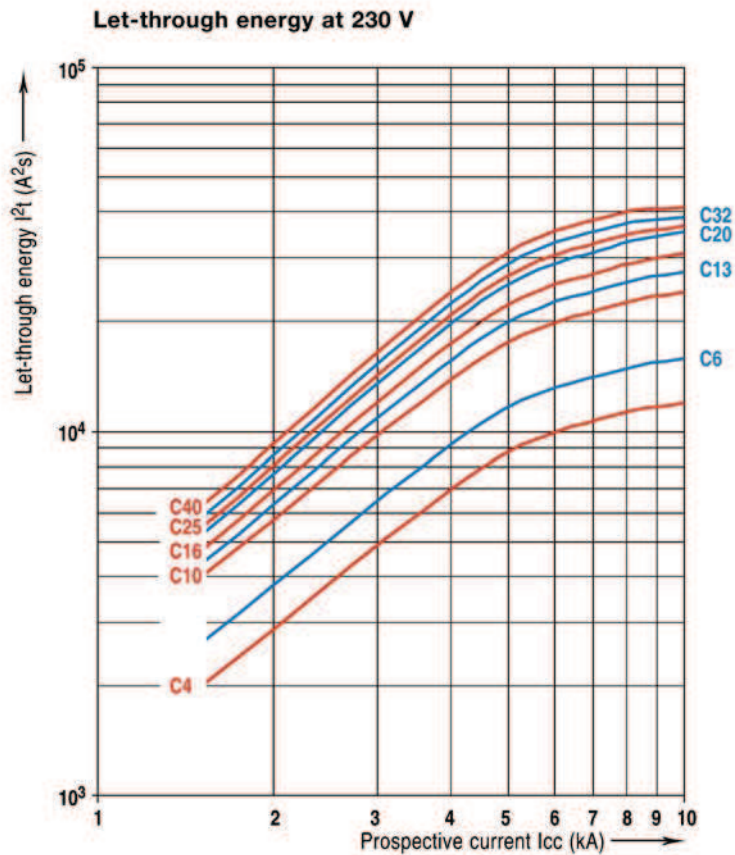

#### RCCB - Din-Safe safety switch (DSRCD)

#### RCBO - Din-Safe (DSRCBH)

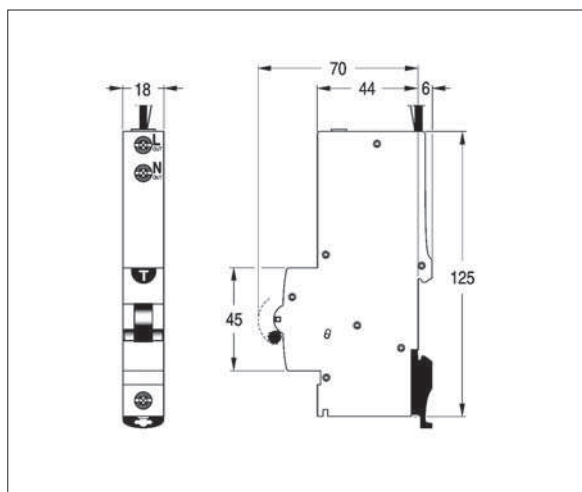

Dimensions in mm

# Din-T MCBs + RCDs Technical data

## Overview Din-Safe RCDs

### RCBO



### Device type definition

Rating/description	Cat. No.	DSRCBH	
Standards		IEC 61009-1	
Magnetic tripping characteristics		C	
Residual tripping characteristic <sup>1)</sup>		A	
Tripping time at I $\Delta$ n	Instantaneous	ms	<300
	Selective	ms	-
Rated current	A	6, 10, 16, 20, 25, 32, 40	
Rated residual current I $\Delta$ n	mA	10, 30	
Calibration temperature	°C	30	
Number of poles versus modules		1	
Rated voltage Un	2 P AC	V	240 (1 P+N)
	3 P AC	V	-
	4 P AC	V	-
Frequency	Hz	50/60	
Maximum service voltage U <sub>bmax</sub>	V	255	
Minimum service voltage U <sub>bmin</sub>	V	100	
Power supply		Bottom	
Selectivity class		3	
Rated making and breaking capacity (I <sub>m</sub> )	A	10xI <sub>n</sub>	
Residual making and breaking capacity (I $\Delta$ m)	A	10000	
Conditional short-circuit capacity (I <sub>nc</sub> )	A	-	
Conditional residual short-circuit capacity (I $\Delta$ c)	A	-	
Short-circuit capacity (I <sub>cn</sub> )	A	10000	
Grid distance (safety distance between two devices)	mm	-	
Isolator application		yes	
Insulation degree	Insulation voltage	V (DC)	500 <sup>2)</sup>
	Shock voltage (1.2/50 ms)	kV	6 <sup>2)</sup>
	Insulation resistance	(mOhm)	1000 <sup>2)</sup>
	Dielectric strength	V	2500 <sup>2)</sup>
Shock resistance (in x, y, z direction)(IEC 60077/16.3)		40 g, 18 shocks 5 ms	
Vibration resistance (in x, y, z direction; IEC 60068-2-6)		2 g, 30 min, 0...80 Hz	
Endurance	electrical at Un, In		10000
	mechanical at Un, In		20000
Protection degree (outside/inside electrical enclosure)		IP 20 / IP 40	
Self extinguish degree (according to UL 94)		V2	
Tropicalisation (according to IEC 60068-2, DIN 40046)	°C/RH	+55/95 %	
Pollution degree (acc. IEC 60947-1)		3	
Operating temperature	°C	-5...+60	
Storage temperature	°C	-25...+70	
Terminals capacity	Rigid cable min/max (Top)	mm <sup>2</sup>	1/25
	Flexible cable min*/max (Top)	mm <sup>2</sup>	1/16
	Rigid cable min/max (bottom)	mm <sup>2</sup>	1/35
	Flexible cable min*/max (bottom)	mm <sup>2</sup>	1/25
	(*Flexible cable 0.75/1.5 mm <sup>2</sup> with cable lug)		
Torque	Top/Bottom	Nm	3
Add-on devices (side add-on)	Auxiliary contacts		-
	UVT		-
	Shunt trip		-
	Motor operator		-
	Panelboard switch		Bottom
Busbars systems	Pin		Bottom
	Fork		yes
<b>Accessories</b>			
Dimensions, weights, packaging		# Poles	1+N
	(HxDxW) 86x68xW	mm	18
	Weight/unit	g	350
<b>Package/unit</b>			1

**Note:** <sup>1)</sup> Refer catalogue section for types.

<sup>2)</sup> Making sure that N-L and both flying leads are disconnected.