



PV-ezRack Product Catalogue



Clenergy is proud to support its customers and is committed to making the world a cleaner and safer place for future generations.



Introduction

With its genesis in Australia and foot print across the world, Clenergy has grown from being a boutique solar solutions provider into a passionate, globally renowned renewable energy company with nearly 400 employees and offices across four continents.

Clenergy's products and services have become synonymous with quality and innovation, delivering a wide range of solutions to industry.

Our mounting systems are universally recognised for their high quality, innovative design and ease of deployment. The service at Clenergy is renowned for being friendly, reliable and professional.

To drive continual improvement we invest heavily in research, development, service, our people and partners. It is this approach that makes Clenergy a trusted company with a reputation as the passionate expert in the renewable energy sector.

Clenergy is committed to delivering a wide range of products and services: local expert staff answer your questions, local logistic companies deliver our products and local engineers ensure that every regulation is fully complied with. Our partners rely on our expertise; support and experience before, during and after the installation, so you can rest assured that when you partner with Clenergy you've made the right decision.

PV-ezRack SolarRoof	3
PV-ezRack SolarTripod	7
PV-ezRack SolarMatrix	9
PV-ezRack SolarMatrix Pro	11
PV-ezRack PostMount 2-A, 3-A and 4-A	14
PV-ezRack PostMount 6-A and 8-A	16
PV-ezRack SolarTerrace II-A	18
PV-ezRack SolarTerrace III-A	20
PV-ezRack SolarTerrace V	22
PV-ezRack ThinFilm	24
Accessories	25

PV-ezRack SolarRoof

Reliable, robust roof mounting system with high quality components designed for the harshest conditions.

PV-ezRack SolarRoof has been developed for residential PV installations on tin and tile roofs. The components are easy to install and can be used for flush as well as tilted systems, on a large variety of roof types. The interfaces, rails and clamps use high quality, robust and corrosion resistant materials including structural grade aluminium alloy (AL6005-T5) and stainless steel (SUS304).

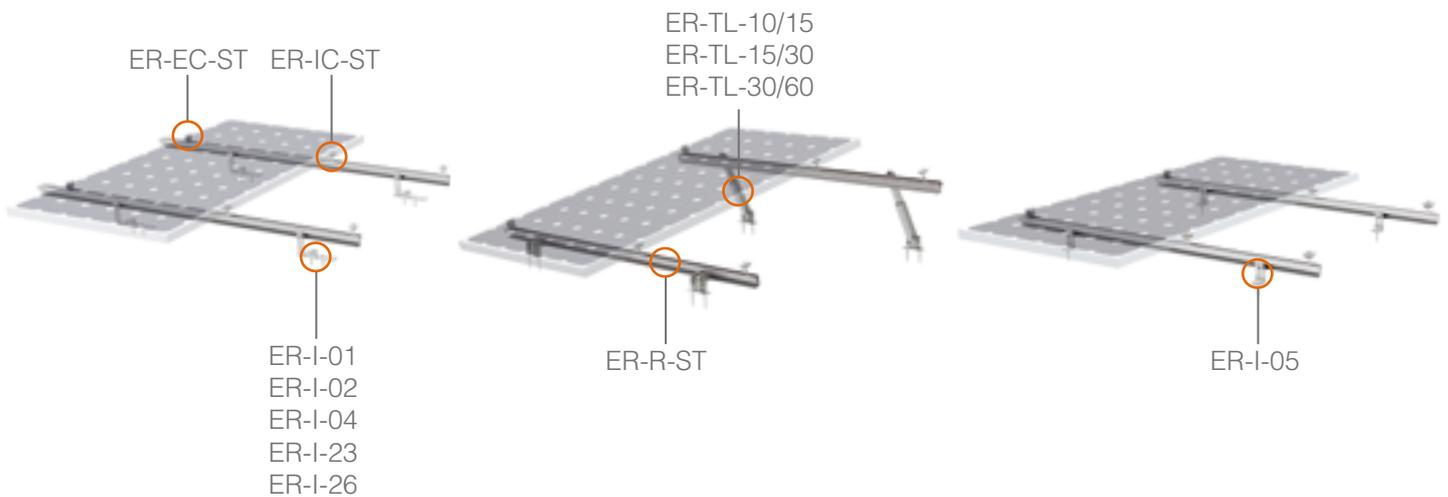

Main Benefits

Quick and easy installation

Innovative and internationally patented, the Z-Module technology is used in almost all SolarRoof components. The Z-Module provides a quick, easy and safe installation method. It can be inserted into the rail at any given point, and secured with just three hand grips.

Versatility

A large variety of roof hooks, tin roof fixings, tilt legs and adapters help ensure that you will find a suitable fixing method for almost every roof, where fixing with penetration is required.

Wide range of tilting

With three adjustable tilt legs, these parts can tilt panels from between 10-60 degrees. Through its innovative design, the tilt legs can cope with all common purlin distances.

Universal

SolarRoof has suitable inter and end clamps for every size of solar panel including frameless, thin film panels or special clamps for cyclonic regions. In the growing range of clamps, cable clips, adapters and accessories you are sure to find the parts you require for your residential rooftop mounting needs.

**10 Year
Warranty***

Commercial

Residential

**Available
accessories**

**Grounding/earthing
Cable clips
Rail caps
Isolator Bracket**

PV-ezRack SolarRoof

Non-penetrative

Reliable, robust roof mounting system with high quality components designed for concealed-fix roof claddings (Klip-lok, Longline).

To achieve and maintain improved watertightness of solar installations on Klip-lok type tin roofs, PV-ezRack SolarRoof has been expanded with a range of non-penetrative brackets. Rigorous testing on real size roofing sheets ensures safety, compliance and structural integrity of the PV-installations. As a result, the Klip-lok type brackets can be used for installing flush to the roof as well as for tiled systems.

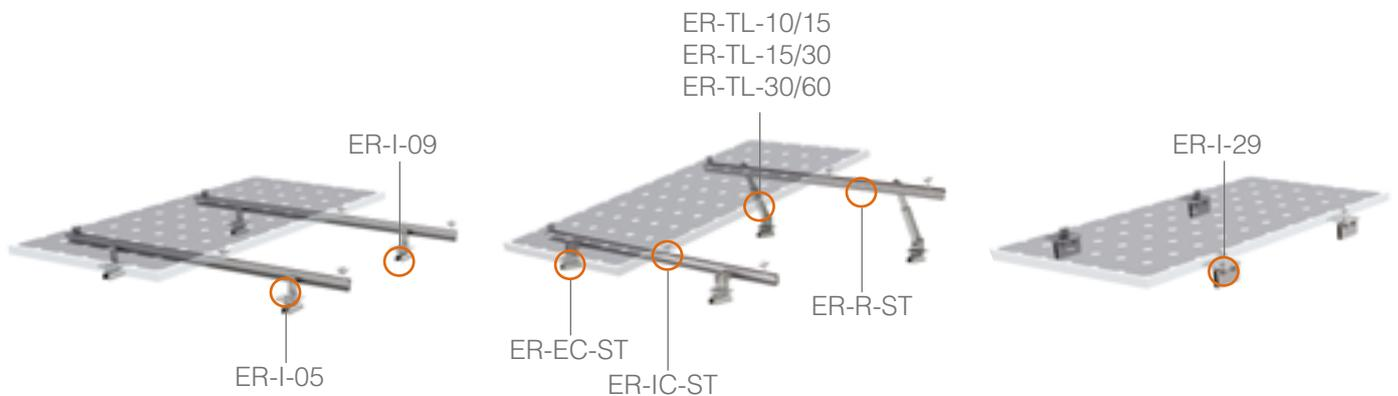

Main Benefits

No roof penetration

Watertightness is easily maintained with the SolarRoof clamps for concealed fix roofs, as there is no need for roof penetration. With Cleenergy's thorough testing methods, this is made possible without any compromises on safety or structural integrity.

Versatility

The non-penetrative clamps can be used for flush installations as well as for tilting. The two fixing methods for flush mounting include direct mounting (no rails) and bracket plus L-feet (with rails). For tilted systems, the adjustable tilt legs or SolarTripod can be used directly on the compatible non-penetrative clamps.

Quick and easy installation

Innovative and internationally patented, the Z-Module technology is used in almost all SolarRoof components. The Z-Module provides a quick, easy and safe installation method. It can be inserted into the rail at any given point, and secured with just three hand grips.

Available accessories

Grounding/earthing
Cable clips
Rail caps
Isolator Bracket

**10 Year
Warranty***

Commercial

Residential

PV-ezRack SolarRoof

ER-I-01



Tile Interface

- Standard roof hook
- Z-Module
- Washer 8.4mm (21/64") DIN 9021 A2
- Lock washer 8mm (5/16") A2
- Hex Socket Head Bolt M8 x 25mm (5/16" x 63/64") 933 A2-70
- Hex Head Wood Screw 6 x 80mm (15/64" x 3-5/32"), thread: 80mm (3-5/32")

ER-I-02



Flat Tile Interface

- Flat Tile Roof Hook
- Z-Module
- Washer 8.4mm (21/64") DIN 9021 A2
- Lock Washer 8mm (5/16") A2
- Hex Socket Head Bolt M8x25mm (5/16" x 63/64") 933 A2-70
- Hex Head Wood Screw 6 x 80mm (15/64" x 3-5/32"), thread: 80mm (3-5/32")

ER-I-23



Tile Interface - Landscape

- Landscape Roof Hook
- Z-Module
- Washer 8.4mm (21/64") DIN 9021 A2
- Lock Washer 8mm (5/16") A2
- Hex Socket Head Bolt M8x25mm (5/16" x 63/64") 933 A2-70
- Hex Head Wood Screw 6 x 80mm (15/64" x 3-5/32"), thread: 80mm (3-5/32")

ER-I-04



Slate Interface

- Slate Roof Hook
- Z-Module
- Washer 8.4mm (21/64") DIN 9021 A2
- Lock Washer 8mm (5/16") A2
- Hex Socket Head Bolt M8 x 25mm (5/16" x 63/64") 933 A2-70
- Hex Head Wood Screw 6 x 80mm (15/64" x 3-5/32"), thread: 80mm (3-5/32")

ER-I-05



Tin Interface

- L-Foot
- Rubber Pad
- Z-Module
- Washer 8.4mm (21/64") DIN 9021 A2
- Lock Washer 8mm (5/16") A2
- Hex Socket Head Bolt M8 x 25mm (5/16" x 63/64") 933 A2-70
- Hex Head Wood Screw 6 x 80mm (15/64" x 3-5/32"), thread: 80mm (3-5/32")

ER-I-26



Tile Interface - Side Mount

- Side Mount Roof Hook
- Z-Module
- Washer 8.4mm (21/64") DIN 9021 A2
- Lock Washer 8mm (5/16")
- Hex Socket Head Bolt M8 x 25mm (5/16" x 63/64") 933 A2-70
- Hex Head Wood Screw 6 x 80mm (15/64" x 3-5/32"), thread: 80mm (3-5/32")

ER-I-09



Klip Lok Interface

- Main Hook
- Side Hook
- Hex Socket Head Bolt M8 x 25mm (5/16" x 63/64")
- Lock Washer 8.4mm (21/64")
- Washer 8.4mm (21/64")
- Rubber pad for Klip Lok interface
- Hex Socket Head Bolt M8 x 20mm (5/16" x 25/32") 933 A2-70
- Suitable for:
 - KLIP-LOK 700
 - KLIP-LOK 406
 - KingKlip
 - Speed Deck Ultra

ER-I-29/AU



Klip-lok Interface for LONGLINE 305

- Main Hook for Klip-lok Interface for longline 305
- Side Hook for Klip-lok Interface for longline 305
- Rubber Pad for Klip-lok Interface for longline 305
- Hexagon Socket bolt M8 x 30mm (5/16" x 1-3/16")
- Spring Washer
- Flat Washer
- Hex Socket Head Bolt M8 x 20mm (5/16" x 25/32") 933 A2-70

ER-I-10/15



Tilt Legs, adjustable 10/15 degree

- Outer Tube 220
- Fix Foot
- L Feet-A
- Lock Washer 8mm (5/16") A2
- Hex Socket Head Bolt M8 x 40mm (5/16" x 1-37/64")
- Hex Socket Head Bolt M8 x 55mm (5/16" x 2-11/64")
- Washer 8.4mm (21/64") DIN 9021 A2
- Hex Socket Head Bolt M8 x 25mm (5/16" x 63/64") 933 A2-70
- Hex Head Wood Screw 6 x 80mm (15/64" x 3-5/32"), 80mm (3-5/32") thread
- Inner Tube 220
- U-Bracket
- Z-Module
- Rubber Pads

PV-ezRack SolarRoof

ER-TL-15/30



Tilt Legs, adjustable 15/30 degree

- Outer Tube 350
- Fix Foot
- L Feet-A
- Lock Washer 8mm (5/16") A2
- Hex Socket Head Bolt M8 x 40mm (5/16" x 1-37/64")
- Hex Socket Head Bolt M8 x 55mm (5/16" x 2-11/64")
- Washer 8.4mm (21/64") DIN 9021 A2
- Hex Socket Head Bolt M8 x 25mm (5/16" x 63/64")
- Hex Head Wood Screw 6 x 80mm (15/64" x 3-5/32"), thread: 80mm (3-5/32")
- Inner Tube 350
- U-Bracket
- Z-Module
- Rubber Pads

ER-TL-30/60



Tilt Legs, adjustable 30/60 degree

- Outer Tube 635
- Fix Foot
- L Feet-A
- Lock Washer 8mm (5/16") A2
- Hex Socket Head Bolt M8 x 40mm (5/16" x 1-37/64")
- Hex Socket Head Bolt M8 x 55mm (5/16" x 2-11/64")
- Washer 8.4mm (21/64") DIN 9021 A2
- Hex Socket Head Bolt M8 x 25mm (5/16" x 63/64")
- Hex Head Wood Screw 6 x 80mm (15/64" x 3-5/32"), thread: 80mm (3-5/32")
- Inner Tube 635
- U-Bracket
- Z-Module
- Rubber Pads

ER-R-ST



Standard Rail

- With a standard lengths of 2560mm (8' 4-25/32"), 3150mm (10' 4-1/64"), 3405mm (11' 2-1/16"), 4200mm (13' 9-23/64")

ER-EC-V/HP90



Module End Clamp HP Series, for Volther 90mm hybrid panel

- HP End Clamp 90
- Z Moudle
- Hexagon socket head cap screw
- M8 x 65mm (5/16" x 2-23/63")
- Washer 8mm (5/16")

ER-SP-ST



Splice for Standard Rail

- Splice with a standard length of 200mm (7/8")
- Hex Socket Head Bolt M8 x 18mm (5/16" x 45/64")

ER-IC-ST



Inter Clamp, Standard

- Inter Module Clamp 28mm (1-7/64"), 35mm (1-3/8"), 40mm (1-37/64"), 46mm (1-13/16"), 50mm (1-31/32"), 57mm (2-1/4")
- 28mm (1-7/64") with Hex Socket Head Bolt A2-70 M8x40mm (5/16" x 1-37/64")
- 35mm (1-3/8") with Hex Socket Head Bolt A2-70 M8x45mm (5/16" x 1-49/64")
- 40mm (1-37/64") with Hex Socket Head Bolt A2-70 M8x50mm (5/16" x 1-31/32")
- 46mm (1-13/16") with Hex Socket Head Bolt A2-70 M8x55mm (5/16" x 2-11/64")
- 50mm (1-31/32") with Hex Socket Head Bolt A2-70 M8x60mm (5/16" x 2-23/64")
- 57mm (2-1/4") with Hex Socket Head Bolt A2-70 M8x70mm (5/16" x 2-3/4")
- Z-Module
- Lock Washer 8.4mm (21/64")

ER-EC-ST



End Clamp, Standard

- End Module Clamp 28mm (1-7/64"), 30mm (1-3/16"), 32mm (1-17/64"), 35mm (1-3/8"), 38mm (1-1/2"), 40mm (1-37/64"), 42mm (1-21/32"), 46mm (1-13/16"), 48mm (1-57/64"), 50mm (1-31/32"), 57mm (2-1/4")
- Z-Module
- Hex Socket Head Bolt A2-70 M8 x 28mm (5/16" x 1-1/10")
- Lock Washer 8.4mm (21/64")

PV-ezRack SolarTripod

Tilted flat roof frame designed for commercial installations

The PV-ezRack SolarTripod is designed for commercial PV-installations on flat roofs with tilted panels in portrait orientation. The supports are available in fix and adjustable tilt angles, in addition they are compatible with a wide range of purlin distances. The components are made entirely of structural grade (AL6005-T5) anodised aluminium and stainless steel. SolarTripod is available in two designs: single and double row panels.

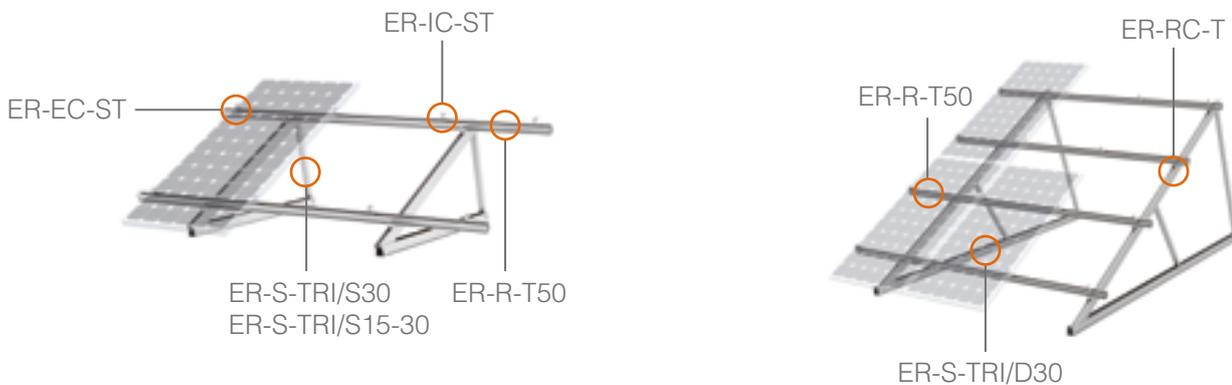

Main Benefits

Quick installation

Completely pre-assembled, the SolarTripod supports simply need to be unfolded and secured to the roof structure for installation. For most installations the legs require only 2 fixing points each and the rails can overcome large spans. All these features result in a fast, easy and cost efficient installation, crucial for commercial projects.

Suitable for corrosive environments

As the materials used in this product are stainless steel (SUS304) and 10µm anodised aluminium it can be installed even in the harshest corrosive environments.

Maximising installation size and output on small roofs

The DoubleTripod has two rows of PV-panels in portrait orientation. This allows you to perfectly utilise narrow roof sections while doubling the installation size and output, where you would normally only be able to fit one row of panels.

Simplicity

Bill of materials can be confusing and complicated. On a basic BOM for SolarTripod you will only find 6 components, keeping it simple and transparent for all parties to better understand and work with the product.

10 Year
Warranty*

Commercial

Residential

Available
accessories

Grounding/earthing
Cable clips
Cable trays
Rail caps

PV-ezRack Solar Tripod

ER-S-TRI/S30



Support Single Tripod 30 degree

- Base Support standard
70 x 1200mm (2-3/4" x 3' 11-1/4")
- Base Support for AU
70 x 1350mm (2-3/4" x 4' 5-5/32")
- Upper Support
75 x 1250mm (2-61/64" x 4' 1-7/32")
- Al-tube 35.5 x 645mm
(1-25/64" x 2' 1-25/64")
- Round Head rivet
Ø10 x 56mm (25/64" x 2-13/64")
- Round Head rivet nut
- Flat head rivet
Ø10 x 47mm (25/64" x 1-27/32")
- Hexagon Socket bolt
M10 x 65mm (25/64" x 2-9/16")
- Hex nut M10mm (25/64")
- Washer M10mm (25/64")
- Flat washer M10mm (25/64")
- U Bracket

ER-S-TRI/D30



Support Double Tripod 30 degree

- Base Support
70 x 3000mm (2-3/4" x 9' 10-7/64")
- Upper Support
75 x 2823mm (2-61/64" x 9' 3-9/64")
- Al-tube 35.5 x 500mm
(1-25/64" x 1' 7-11/16")
- Al-tube 35.5 x 1290mm
(1-25/64" x 4' 2-25/32")
- Round Head rivet
Ø10 x 56mm (25/64" x 2-13/64")
- Round Head rivet nut
- Flat head rivet
Ø10 x 47mm (25/64" x 1-27/32")
- Hexagon Socket bolt
M10 x 65mm (25/64" x 2-9/16")
- Hex nut M10mm (25/64")
- Washer M10mm (25/64")
- Flat washer M10mm (25/64")
- U Bracket

ER-S-TRI/S15-30



Adjustable Tripod

- Base Support
70 x 1350mm (2-3/4" x 4' 5-5/32")
- Upper Support
75 x 1250mm (2-61/64" x 4' 1-7/32")
- Leg Tube 358mm (1' 2-3/32")
- Leg Strug 348mm (1' 1-45/64")
- Bushing Ø16 x 7mm (5/8" x 9/32")
- Fixing block with two holes
- Set Screw ØM8 x 12mm
- Hexagon Socket bolt
M10 x 65mm (25/64" x 2-9/16")
- Hex nut M10mm (25/64")
- Washer M10mm (25/64")
- Flat washer M10mm (25/64")
- U Bracket

ER-R-T50



T-Rail 50

- With a standard lengths of
2560mm (8' 4-25/32")
3405mm (11' 2-1/16")
4200mm (13' 9-23/64")

ER-SP-T50



Splice for T-Rail 50

- Splice with standard length of
300mm (11-13/16")
- Self-Tapping Screw ST6.3x22
(1/4" x 55/64")

ER-RC-T



Rail Clamp for T-Rail

- Rail Clamp 50 x 30 x 11.8mm
(1-31/32" x 1-3/16" x 15/32")
- Hex Socket Head Bolt
M8 x 30mm (5/16" x 1-3/16")
- Z-Module
- Spring Washer M8 (5/16")

ER-IC-ST



Inter Clamp, Standard

- Inter Module Clamp 28mm (1-7/64"),
35mm (1-3/8"), 40mm (1-37/64"),
46mm (1-13/16"), 50mm (1-31/32"),
57mm (2-1/4")
- 28mm (1-7/64") with Hex Socket Head
Bolt A2-70 M8x40mm (5/16" x 1-37/64")
- 35mm (1-3/8") with Hex Socket Head
Bolt A2-70 M8x45mm (5/16" x 1-37/65")
- 40mm (1-37/64") with Hex Socket Head
Bolt A2-70 M8x50mm (5/16" x 2-10/64")
- 46mm (1-13/16") with Hex Socket Head
Bolt A2-70 M8x55mm (5/16" x 2-11/64")
- 50mm (1-31/32") with Hex Socket Head
Bolt A2-70 M8x60mm (5/16" x 2-5/3")
- 57mm (2-1/4") with Hex Socket Head
Bolt A2-70 M8x70mm (5/16" x 2-3/4")
- Z-Module
- Lock Washer 8.4mm (21/64")

ER-EC-ST



Inter Clamp, Standard

- End Module Clamp
28mm (1-7/64")
30mm (1-3/16")
32mm (1-17/64")
35mm (1-3/8")
38mm (1-1/2")
40mm (1-37/64")
42mm (1-21/32")
46mm (1-13/16")
48mm (1-57/64")
50mm (1-31/32")
57mm (2-1/4")
- Z-Module
- Hex Socket Head Bolt A2-70
M8 x 28mm (5/16" x 1-1/10")
- Lock Washer 8.4mm (21/64")

ER-RC-T/A



Positioning Rail Clamp for T-Rail

- Positioning Rail Clamp 50 x 27.25 x
11.5mm (1-5/64" x 1-5/64" x 29/64")
- Hex Socket Head Bolt
M8 x 30mm (5/16" x 1-3/16")
- Spring Washer M8 (5/16")
- Z-Module

ER-RC-T/G



Rail Clamp for T-Rail with grounding/earthing pins

- Rail Clamp with pins 50 x 30 x 11.8mm
(1-31/32" x 1-3/16" x 15/32")
- Hex Socket Head Bolt M8 x 30mm
(5/16" x 1-3/16")
- Spring Washer M8 (5/16")
- Z-Module

PV-ezRack SolarMatrix

Ballasted flat roof system with maximum roof utilisation ratio

Clenergy PV-ezRack SolarMatrix is a non-penetrative mounting system for commercial concrete flat roof installations. Through its flexible and scalable design it enables perfect utilisation of roof surface available. The tilt angles range from 5° to 20° with the panels positioned in landscape orientation. A combination of high quality aluminium and stainless steel components make a robust, reliable system with excellent corrosion resistance.

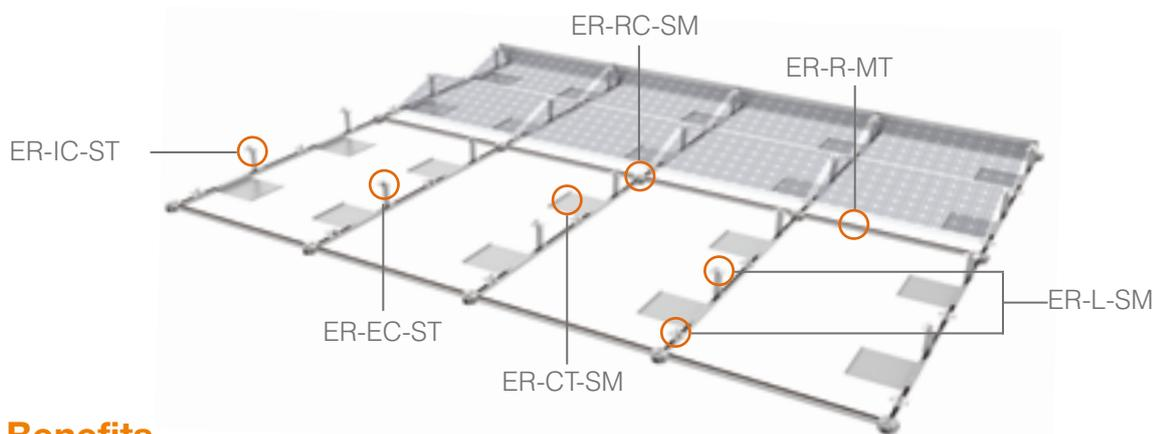

Main Benefits

No roof penetration

Using ballast trays with mostly concrete ballast blocks, SolarMatrix is held securely in place without the need for roof penetration, ensuring that watertightness of the building remains intact.

Maximum roof utilisation ratio

SolarMatrix allows maximum flexibility. Even the smallest roof section can be used for generating power and the modular design allows for easy layout customisation.

Good corrosion resistance

The panels are mounted on stainless steel front and back legs, secured on the anodised aluminium base MT-Rails with our Diamond Modules.

Quick and easy installation

A modular design and Diamond Module connection provide a quick, easy and safe installation method. Through its design, the Diamond Module safely clicks into its required position when turned inside of the MT-rail. It can be inserted into the rail at any given point, and secured with just three hand grips.

**10 Year
Warranty***

Commercial

Residential

**Available
accessories**

**Grounding/earthing
Cable clips**

PV-ezRack SolarMatrix

ER-R-MT/2560



MT-rail

- Project specific customised lengths

ER-SP-MT



Splice for MT Rail

- Hex Socket Head Bolt A2-70 M8 x 20mm (5/16" x 25/32")
- Diamond Module
- Stainless Steel Splice

ER-RC-SM



Rail Cross Connector

- Cross Connector-Base
- Cross Connector-Top
- Washer 10mm (25/64")
- Hex Socket Head Bolt A2-70 10mm (25/64")

ER-CT-SM



Ballast Tray

- Hex Socket Head Bolt A2-70 M8 x 20mm (5/16" x 25/32")
- Diamond Module

ER-L-SM



Front and Back Leg

- Front and Back Leg 5°
- Front and Back Leg 10°
- Front and Back Leg 15°
- Front and Back Leg 20°
- Hex Socket Head Bolt A2-70 M8 x 20mm (5/16" x 25/32")
- Diamond Module

ER-WD-SM



Wind Deflectors

- Wind Deflectors 5°
- Wind Deflectors 10°
- Wind Deflectors 15°
- Wind Deflectors 20°
- Lock Card
- Hex Socket Head Bolt A2-70 M8 x 75mm (5/16" x 2-61/64")
- Hex Socket Head Bolt A2-70 M8 x 20mm (5/16" x 25/32")
- Hex Nut M8mm (5/16") DIN 934 A2
- Diamond Module

ER-IC-SM



Inter Clamp

- Inter Module Clamp add 28mm (1-7/64")
35mm (1-3/8"), 40mm (1-37/64"), 46mm (1-13/16"), 50mm (1-31/32"), 57mm (2-1/4")
- 28mm (1-7/64") with Hex Socket Head Bolt A2-70 M8x40mm (5/16" x 1-37/64")
- 35mm (1-3/8") with Hex Socket Head Bolt A2-70 M8x45mm (5/16" x 1-49/64")
- 40mm (1-37/64") with Hex Socket Head Bolt A2-70 M8x50mm (5/16" x 1-31/32")
- 46mm (1-13/16") with Hex Socket Head Bolt A2-70 M8x55mm (5/16" x 2-11/64")
- 50mm (1-31/32") with Hex Socket Head Bolt A2-70 M8x60mm (5/16" x 2-23/64")
- 57mm (2-1/4") with Hex Socket Head Bolt A2-70 M8x70mm (5/16" x 2-3/4")

ER-EC-SM



End Clamp

- End Module Clamp
28mm (1-7/64")
30mm (1-3/16")
32mm (1-17/64")
35mm (1-3/8")
38mm (1-1/2")
40mm (1-37/64")
42mm (1-21/32")
46mm (1-13/16")
48mm (1-57/64")
50mm (1-31/32")
57mm (2-1/4")
- Hex Socket Head Bolt A2-70 M8 x 28mm (5/16" x 1-1/10")
- Lock Washer 8.4mm (21/64")

PV-ezRack SolarMatrix Pro

Innovative ballasted flat roof system for concrete membrane roofs

SolarMatrix Pro is a unique and innovative flat mounting system designed for concrete membrane roofs. It provides tilt angles from 10° to 25°. The distinctive feature of this product is that it allows access to the roof surface for maintenance under the solar arrays. As such, the arrays don't need to be removed if the roof or membrane requires servicing. This is achieved through a smart pivoting system which allows for what is possibly the easiest installation on the market for ballasted systems. Added value is provided through an aesthetically pleasing appearance.

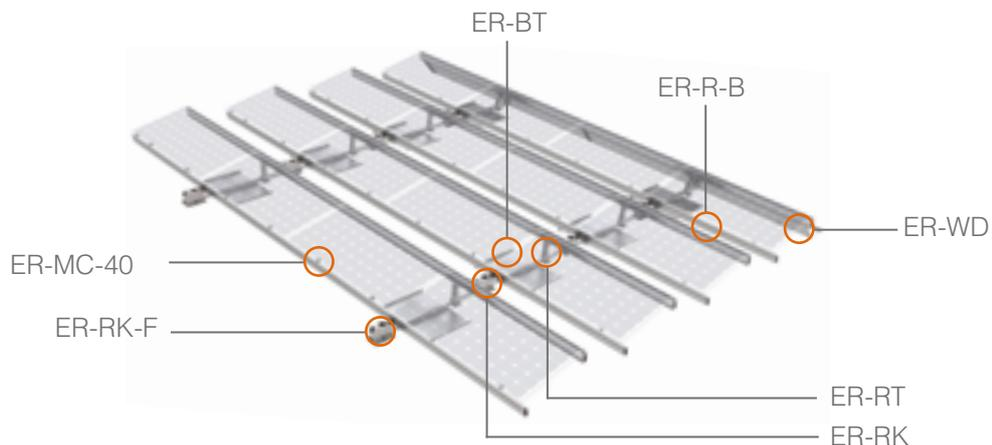

Main Benefits

No roof penetration

Using ballast trays with mostly concrete ballast blocks, SolarMatrix Pro is held securely in place without the need for roof penetration, ensuring that watertightness of the building remains intact.

Easy and quick installation through pivoting

The two legs (Kedge) can hold up to four panels, greatly reducing labour time. Module clamps secure the PV panels from the back which is easily accessible through the pivoting function of the legs. Panels are held securely in vertical position using an auto lock function until the cabling and earthing work is completed. The array can then be unlocked, simply tilted by hinge into their final position, and locked in without a need for a single bolt, nut or tool. All of these features make the installation a very easy process.

Free roof access for maintenance

In case of roof maintenance, the pivoting function can be easily activated simply with a screw driver. Panels can then be tilted to vertical position allowing free access to the roof or membrane.

Excellent corrosion resistance

The standard SolarMatrix Pro only uses aluminium and stainless steel. Rails and clamps are entirely made of structural grade AL6005-T5 aluminium. The legs, or 'Rail Kedges', are powder coated cast aluminium ADC 12.

**10 Year
Warranty***

Utility

Commercial

Available accessories

**Grounding/earthing
Cable clips
Rail Caps**

PV-ezRack SolarMatrix Pro

ER-RK



Rail Kedge

- Rail Kedge-L
- Rail Kedge-R
- Pedal
- Bottom Rail Clamp Pro A
- Bottom Rail Clamp Pro B
- Rail Kedge Tube-1
- Rail Kedge Tube-2
- Rail Kedge Tube-3
- Plinth-1-L
- Plinth-1-R
- Plinth-2-L
- Plinth-2-R
- Spring
- Sleeve
- Pedal Bolt
- Snap-head bolt M10 (25/64")
- Snap-head bolt
M8 x 60mm (5/16" x 2-23/64")
- Hex Socket Head Bolt
M8 x 25mm (5/16" x 63/64")
- Lock washer M8 (5/16")
- Lock washer M10 (25/64")

ER-RK-F



Rail Kedge Front Unit

- Rail Kedge-L
- Rail Kedge-R
- Pedal
- Bottom Rail Clamp Pro A
- Bottom Rail Clamp Pro B

ER-RT



Rectangular Tube

- Rectangular Tube
35 x 50mm (1-3/8" x 1-31/32")

ER-SP-B



Rectangular Tube

- Splice
- Tek Screws

ER-R-B



B-Rail

- B-Rail for 2, 3 and 4 modules

ER-RC-B/RK



Rail Clamp of the back side of the Rail Kedge

- Top Rail Clamp-A
- Top Rail Clamp-B
- Snap-head bolt M10 (25/64")
- Nut M10 (25/64")
- Lock washer M10 (25/64")
- Washer M10 (25/64")

ER-MC-40

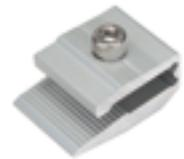

Module Clamp 40mm (1.6")

- Module Clamp 40mm (1-37/64")
- Hex Socket Head Bolt M8 x 25mm
(5/16" x 63/64")

PV-ezRack SolarMatrix Pro

ER-MC-S



Space Clamp

- Module Space Clamp 20mm (25/32")
- Hex Socket Head Bolt M8 x 25mm (5/16" x 63/64")

ER-BT-640/600



Ballast Tray 640 x 600mm (2' 1-13/64" x 1' 11-5/8 ") for Rectengular tube 35 x 50mm (1-3/8" x 1-31/32")

- Ballast Tray Pro 640 x 600 x 2mm (2' 1-13/64" x 1' 11-5/8 " x 5/64")
- Ballast Tray Pro 640 x 800 x 2mm (2' 1-13/64" x 2' 7-1/2" x 5/64")

ER-WD



Wind Deflector

- Wind Deflector Left, 15°, 990mm (3' 2-31/32") panel
- Wind Deflector Middle-Left, 15°, 990mm (3' 2-31/32") panel
- Wind Deflector Middle-Right, 15°, 990mm (3' 2-31/32") panel
- Wind Deflector Right, 15°, 990mm (3' 2-31/32") panel

ER-C-WD



Clamp for Wind Deflector

- Clamp for Wind Deflector
- Hex Socket Head Bolt M8 x 25mm (5/16" x 63/64")

PV-ezRack

PostMount 2-A, 3-A and 4-A

Robust pole mount system with adjustable angle for two, three and four panels

PV-ezRack PostMount-A delivers flexible and durable designs to mount from two to four panels per post. It's ideal for remote off-grid applications such as water pumps or small residential and commercial systems. The panel tilt is easily adjustable between 0° and 60° throughout the year and comes with hassle-free mounting thanks to patented components such as the PV-ezRack rails and clamps. The combination of high quality aluminium, stainless steel and galvanised steel components make this a robust, reliable system with excellent corrosion resistance.

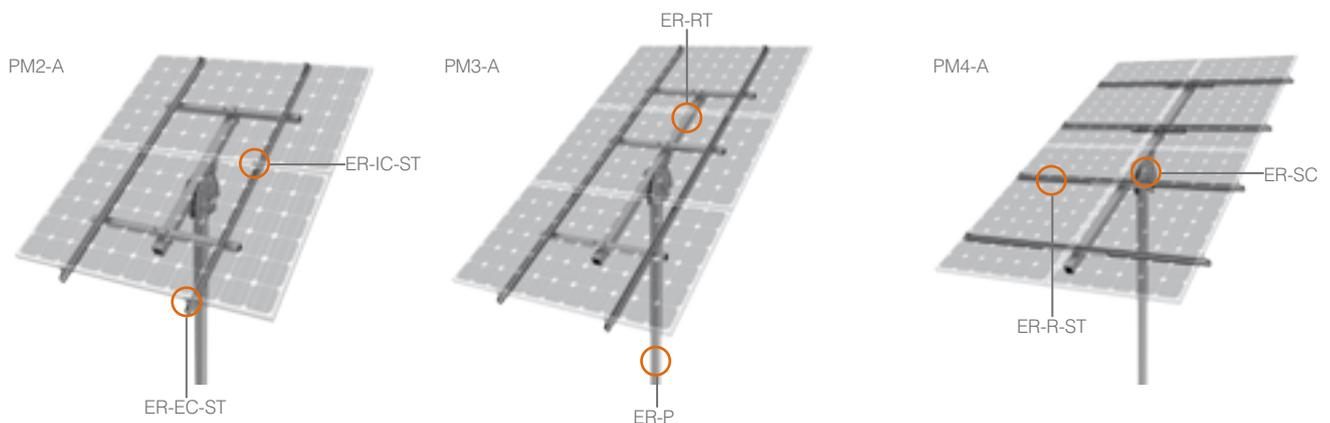

Main Benefits

Suitable for every soil condition

With its concrete foundation, PostMount can be installed on even or uneven ground or on a slope, making it suitable for any soil type and a wide range of applications.

Adjustable tilt angle

The steel cap (post head) is designed to tilt panels between 0° and 60° to ensure that you get the required power output you need - anywhere, anytime. Changing the angle merely requires a single pair of spanners.

Robust and reliable

Mounted on aluminium rails the panels are supported by robust galvanised steel landscape and master tubes secured with stainless steel bolts. The post is fixed into a concrete foundation.

Quick and easy installation

Innovative and internationally patented, the Z-Module technology is used in almost all PV-ezRack components. The Z-Module provides a quick, easy and safe installation method and can be inserted into the rail at any given point, secured with just three hand grips.

**10 Year
Warranty***

Commercial

Residential

**Available
accessories**

**Grounding/earthing
Cable clips**

PV-ezRack

PostMount 2-A, 3-A and 4-A

ER-P



Pole

- PM2-A 83 x 2400mm (3-17/64" x 7' 10-31/64")
- PM3-A 102 x 2600mm (4-1/64" x 8' 6-23/64")
- PM4-A 102 x 2700mm (4-1/64" x 8' 10-19/64")

ER-R-ST

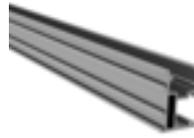

Standard Rail

- With a standard length of 2560mm (8' 4-25/32")
- 3150mm (10' 4-1/64")
- 3405mm (11' 2-1/16")
- 4200mm (13' 9-23/64")

ER-RT-A



Rectangular Tube-Adjustable

- PM2-A 60 x 40 x 481mm (2-23/64" x 1-37/64" x 1' 6-15/16")
- PM3-A 70 x 50 x 496mm (2-3/4" x 1-31/32" x 7-17/32")
- PM4-A 70 x 50 x 496mm (2-3/4" x 1-31/32" x 7-17/32")

ER-RT



Rectangular Tube-Master (for PostMount 2, 3 & 4)

- PM2-A 1200 x 60 x 60mm (3' 11-1/4" x 2-23/64" x 2-23/64")
- PM3-A 1700 x 70 x 70mm (5' 6-59/64" x 2-3/4" x 2-3/4")
- PM4-A 2800 x 70 x 70mm (9' 2-15/64" x 2-3/4" x 2-3/4")

ER-AB



Angle Bracket 63x63x500mm (2.5"x 2.5"x 19.7") (for PostMount 2 and 4)

- U Bolt M10x100mm (25/64" x 3-15/16")
- Nut M10 (25/64")
- Washer 10mm (25/64")
- Hex Socket Head Bolt M8 x 20mm (5/16" x 25/32")
- Washer 8mm (5/16")
- Z-Module

ER-SC



Steel Cap

- PM2-A Ø85mm (3-11/32")
- PM3-A Ø103mm (4-1/16")
- PM4-A Ø103mm (4-1/16")
- Set Screw M12x20mm (15/32" x 25/32")
- Hex Socket Head Bolt M14 x 110mm (35/64" x 4-21/64")
- Nut M14 (35/64")
- Washer 14mm (35/64")
- Lock Washer 14mm (35/64")

ER-IC-ST



Inter Clamp, Standard

- Inter Module Clamp 28mm (1-7/64"), 35mm (1-3/8"), 40mm (1-37/64"), 46mm (1-13/16"), 50mm (1-31/32"), 57mm (2-1/4")
- 28mm (1-7/64") with Hex Socket Head Bolt A2-70 M8x40mm (5/16" x 1-37/64")
- 35mm (1-3/8") with Hex Socket Head Bolt A2-70 M8x45mm (5/16" x 1-49/64")
- 40mm (1-37/64") with Hex Socket Head Bolt A2-70 M8x50mm (5/16" x 1-31/32")
- 46mm (1-13/16") with Hex Socket Head Bolt A2-70 M8x55mm (5/16" x 2-11/64")
- 50mm (1-31/32") with Hex Socket Head Bolt A2-70 M8x60mm (5/16" x 2-23/64")
- 57mm (2-1/4") with Hex Socket Head Bolt A2-70 M8x70mm (5/16" x 2-3/4")
- Z-Module
- Lock Washer 8.4mm (21/64")

ER-EC-ST



End Clamp, Standard

- End Module Clamp 28mm (1-7/64"), 30mm (1-3/16"), 32mm (1-17/64"), 35mm (1-3/8"), 38mm (1-1/2"), 40mm (1-37/64"), 42mm (1-21/32"), 46mm (1-13/16"), 48mm (1-57/64"), 50mm (1-31/32"), 57mm (2-1/4")
- Z-Module
- Hex Socket Head Bolt A2-70 M8 x 28mm (5/16" x 1-1/10")
- Lock Washer 8.4mm (21/64")

PV-ezRack

PostMount 6-A and 8-A

Robust pole mount system with adjustable angle for six and eight panels

PV-ezRack PostMount-A delivers flexible and durable designs to mount six or eight panels per post. It is ideal for remote off-grid applications such as water pumps or small residential and commercial systems. The panel tilt is easily adjustable between 0° and 60° throughout the year and comes with hassle-free mounting thanks to patented components such as the PV-ezRack rails and clamps. The combination of high quality aluminium, stainless steel and galvanised steel components make this a robust, reliable system with excellent corrosion resistance.

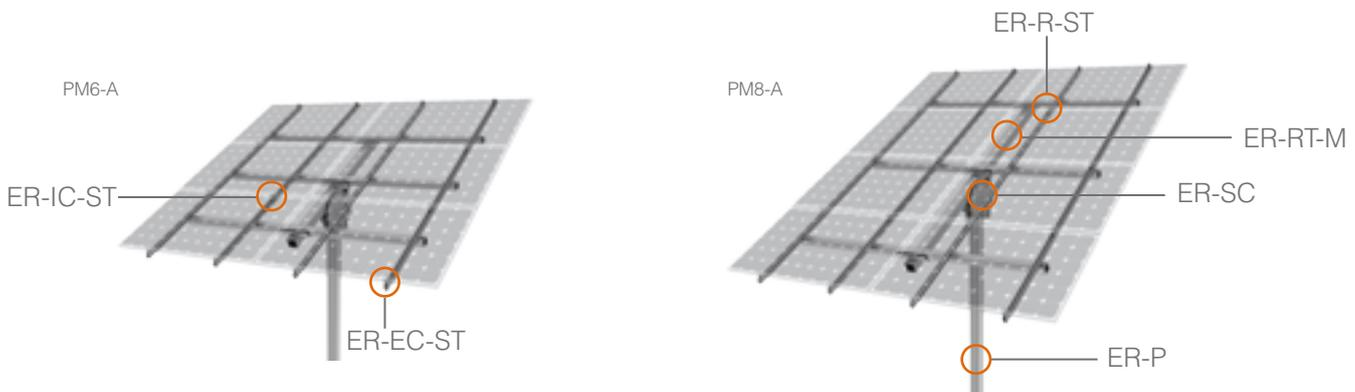

Main Benefits

Suitable for every soil condition

With its concrete foundation, PostMount can be installed on even or uneven ground or on a slope, making it suitable for any soil type and a wide range of applications.

Adjustable tilt angle

The steel cap (post head) is designed to tilt panels between 0° and 60° to ensure that you get the required power output you need - anywhere, anytime. Changing the angle merely requires a single pair of spanners.

Robust and reliable

Mounted on aluminium rails the panels are supported by robust galvanised steel landscape and master tubes secured with stainless steel bolts. The post is fixed in to a concrete foundation.

Quick and easy installation

Innovative and internationally patented, the Z-Module technology is used in almost all PV-ezRack components. The Z-Module provides a quick, easy and safe installation method and can be inserted in to the rail at any given point, secured with just three hand grips.

**10 Year
Warranty***

Commercial

Residential

**Available
accessories**

**Grounding/earthing
Cable clips
Isolator bracket
Rail cap**

PV-ezRack

PostMount 6-A and 8-A

ER-P



Pole

- PM6-A 152 x 3000mm (5-63/64" x 9' 10-7/64")
- PM8-A 152 x 3100mm (5-63/64" x 10' 2-3/64")

ER-R-ST

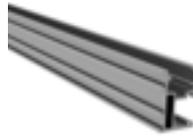

Standard Rail

- With a standard length of 2560mm (8' 4-25/32")
- 3150mm (10' 4-1/64")
- 3405mm (11' 2-1/16")
- 4200mm (13' 9-23/64")

ER-RT-A



Rectangular Tube-Adjust

- PM6-A, PM8-A Rectangular Tube-Adjust 100 x 50 x 506mm (3-15/16" x 1' 1-31/32" x 1' 7-59/64")

ER-RT



Rectangular Tube-Master

- PM6-A 100 x 100 x 1700mm (3-15/16" x 3-15/16" x 5' 6-59/64")
- PM8-A 100 x 100 x 1980mm (3-15/16" x 3-15/16" x 6' 5-61/64")

ER-RT-L



Rectangular Tube-Landscape

- PM6-A 70 x 70 x 2646mm (2-3/4" x 2-3/4" x 8' 8-11/64")
- PM8-A 80 x 80 x 2646mm (3-5/32" x 3-5/32" x 8' 8-11/64")

ER-SC



Steel Cap Ø156mm (6.1")

- PM2-A Ø55mm (2-11/64")
- PM3-A Ø103mm (4-1/16")
- PM4-A Ø103mm (4-1/16")
- Set Screw M12 x 20mm (15/32" x 25/32")
- Hex Socket Head Bolt M14 x 110mm (35/64" x 4-21/64")
- Nut M14mm (35/64")
- Washer 14 (35/64")
- Lock Washer 14 (35/64")

ER-IC-ST



Inter Clamp, Standard

- Inter Module Clamp 28mm (1-7/64"), 35mm (1-3/8"), 40mm (1-37/64"), 46mm (1-13/16"), 50mm (1-31/32"), 57mm (2-1/4")
- 28mm (1-7/64") with Hex Socket Head Bolt A2-70 M8x40mm (5/16" x 1-37/64")
- 35mm (1-3/8") with Hex Socket Head Bolt A2-70 M8x45mm (5/16" x 1-49/64")
- 40mm (1-37/64") with Hex Socket Head Bolt A2-70 M8x50mm (5/16" x 1-31/32")
- 46mm (1-13/16") with Hex Socket Head Bolt A2-70 M8x55mm (5/16" x 2-11/64")
- 50mm (1-31/32") with Hex Socket Head Bolt A2-70 M8x60mm (5/16" x 2-23/64")
- 57mm (2-1/4") with Hex Socket Head Bolt A2-70 M8x70mm (5/16" x 2-3/4")
- Z-Module
- Lock Washer 8.4mm (21/64")

ER-EC-ST



End Clamp, Standard

- End Module Clamp 28mm (1-7/64"), 30mm (1-3/16"), 32mm (1-17/64"), 35mm (1-3/8"), 38mm (1-1/2"), 40mm (1-37/64"), 42mm (1-21/32"), 46mm (1-13/16"), 48mm (1-57/64"), 50mm (1-31/32"), 57mm (2-1/4")
- Z-Module
- Hex Socket Head Bolt A2-70 M8 x 28mm (5/16" x 1-1/10")
- Lock Washer 8.4mm (21/64")

PV-ezRack SolarTerrace II-A

Pre-assembled, durable ground mount frame with ramming

PV-ezRack SolarTerrace II-A is a pre-assembled ground mount system suitable for commercial and utility scale installations. This quality frame is trimmed at every angle for fast deployment reducing labour costs. It was designed with a unique post profile which allows reduced embedment and therefore saves on material and labour. Furthermore it has an industry leading 80µm hot dip galvanisation and 10µm anodisation thickness as standard which ensures a long life cycle. These features, combined with its high grade of pre-assembly make SolarTerrace II-A one of the best ground mount system you can find.

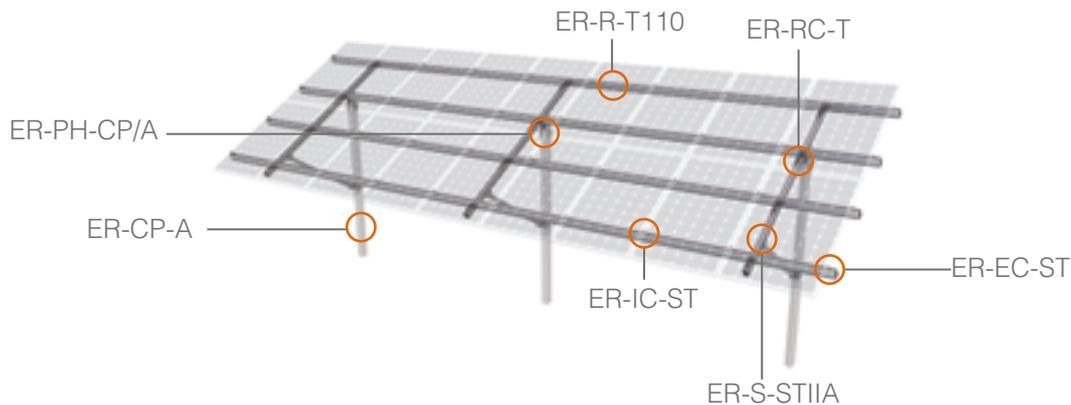

Main Benefits

Reduced labour costs

Through our unique, patented component design and pre-assembled supports with pre-installed positioning clamps labour time and costs are greatly reduced.

Reduced component costs

Our unique C-Post was designed specifically for ramming. This results in an increased friction against up-lift and it therefore requires less embedment as conventional standard posts or I-beams, which reduces not only labour time for ramming but also material costs.

Wide range of adjustments

As ramming can never be 100% accurate the Post head is designed with sufficient horizontal rotation and vertical adjustments. This combined with a generous design tolerance levels makes it easy to get the panels perfectly aligned even if the ramming isn't 100%.

Simplicity

Sometimes bill of materials can be confusing and complicated. Not with Clenergy, on a BOM for STII-A you will only find 9 components. Keeping it simple and transparent helps all parties to understand and work with the product better.

**10 Year
Warranty***

Utility

Commercial

Available accessories

Grounding/earthing
Cable clips
Cable trays
Inverter/joint box bracket
Rail and Girder cap

PV-ezRack SolarTerrace II-A

ER-CP-A



C-Post A

- Foundation C-Post 140 x 95 mm (5-37/64" x 3-47/64")

ER-PH-CP/A



Post Head for C-Post A

- Clasp AL/6005-T5
- V-Spring
- T-Head 142 x 170 x 127mm (5-19/32" x 6-11/16" x 5")
- T-Head Base 142 x 170 x 140.25mm (5-19/32" x 6-11/16" x 5-33/64")
- Hex Socket Head Bolt M12 x 35mm (15/32" x 1-3/8")
- Hex Socket Head Bolt M12 x 130mm (15/32" x 5-1/8")
- Flat Washer 12mm (15/32")
- Spring Washer 12mm (15/32")
- Hexagonal Nut

ER-PB-CP/A



Post Brace for C-Post A

- Hinge Leaf
- Post Joint
- Rivet 2
- Hex Socket Head Bolt M10 x 30mm (25/64" x 1-3/16")
- Hex Socket Head Bolt M14 x 100mm (35/64" x 3-15/16")
- Spring Washer 12mm (15/32")
- Flat Washer 12 (15/32")
- Hexagonal Nut M14 (35/64")

ER-S-STIIA



Support (pre-assembled)

- Tri Groove Beam
- H-Joint
- Hex Socket Head Bolt M14 x 115mm (35/64" x 4-17/32")
- Hex Socket Head Bolt M14 x 100mm (35/64" x 3-15/16")
- Hex Socket Head Bolt M12 x 30mm (15/32" x 1-3/16")
- Spring Washer 12mm (15/32")
- Joint Shoe 60 x 73 x 116.6mm (2-23/64" x 2-7/8" x 4-19/32")
- Tube Support
- Flange Facing Nut M12 (15/32")
- Spring Washer 12mm (15/32")
- Flat Washer 14 (35/64")
- Hexagonal Nut M14 (35/64")
- Corrugated H-Joint
- Corrugated Shim

ER-IC-ST/U18



Inter Clamp, Standard

- Inter Module Clamp 28mm (1-7/64"), 35mm (1-3/8"), 40mm (1-37/64"), 46mm (1-13/16"), 50mm (1-31/32"), 57mm (2-1/4")
- 28mm (1-7/64") with Hex Socket Head Bolt A2-70 M8x40mm (5/16" x 1-37/64")
- 35mm (1-3/8") with Hex Socket Head Bolt A2-70 M8x45mm (5/16" x 1-49/64")
- 40mm (1-37/64") with Hex Socket Head Bolt A2-70 M8x50mm (5/16" x 1-31/32")
- 46mm (1-13/16") with Hex Socket Head Bolt A2-70 M8x55mm (5/16" x 2-1/64")
- 50mm (1-31/32") with Hex Socket Head Bolt A2-70 M8x60mm (5/16" x 2-23/64")
- 57mm (2-1/4") with Hex Socket Head Bolt A2-70 M8x70mm (5/16" x 2-3/4")
- Z-Module
- Lock Washer 8.4mm (21/64")

ER-EC-ST



End Clamp, Standard

- End Module Clamp 28mm (1-7/64"), 30mm (1-3/16"), 32mm (1-17/64"), 35mm (1-3/8"), 38mm (1-1/2"), 40mm (1-37/64"), 42mm (1-21/32"), 46mm (1-13/16"), 48mm (1-57/64"), 50mm (1-31/32"), 57mm (2-1/4")
- Z-Module
- Hex Socket Head Bolt A2-70 M8 x 28mm (5/16" x 1-1/10")
- Lock Washer 8.4mm (21/64")

ER-RC-T



Rail Clamp for T-Rail

- Rail Clamp 50 x 30 x 11.8mm (1-31/32" x 1-3/16" x 15/32")
- Hex Socket Head Bolt M8 x 30mm (5/16" x 1-3/16")
- Z-Module
- Spring Washer M8 (5/16")

ER-R-T110



T-Rail 110

- T-Rail 65 x 110mm (2-9/16" x 4-21/64")
- Length from 2000mm (6' 6-47/24") to 6100mm (20' 5/32")
- Standard Lengths 4200mm (13' 9-23/64") and 5200mm (17' 23/32")

ER-SP-T110



Splice for T-Rail 110

- Splice 45.7 x 105.6mm (1-51/64" x 4-1/15")
- Flange Face Self-Tapping Screw
- Self tapping screw M6.3 x 22mm (1/4" x 55/64")

ER-RC-T/A



Positioning Rail Clamp for T-Rail

- Positioning Rail Clamp 50 x 27.25 x 11.5mm (1-5/64" x 1-5/64" x 29/64")
- Hex Socket Head Bolt M8 x 30mm (5/16" x 1-3/16")
- Spring Washer M8 (5/16")
- Z-Module

ER-RC-T/G



Rail Clamp for T-Rail with grounding/earthing pins

- Rail Clamp with pins 50 x 30 x 11.8mm (1-31/32" x 1-3/16" x 15/32")
- Hex Socket Head Bolt M8 x 30mm (5/16" x 1-3/16")
- Spring Washer M8 (5/16")
- Z-Module

PV-ezRack SolarTerrace III-A

Universal ground mount frame for corrosive environments and for tough soil conditions

Manufactured from high quality structural grade and anodised aluminium PV-ezRack SolarTerrace III-A is the perfect mounting solution for corrosive environments. The support legs can be installed either with concrete ballast footing or on ground screws which makes it suitable for almost every soil condition. Its user friendly high level of prefabrication makes it easy to install and therefore practical for smaller commercial and even for residential installations. STIII-A is also suitable for fixing thin film panels.



Main Benefits

Durable even in harsh environments

STIII-A contains only 6005-T5 Aluminium alloy and 304 stainless steel (316 on request), which makes it suitable for even the toughest environments, such as corrosive sites close to coastlines.

Support leg is delivered in one piece

The support legs of the STIII-A are completely pre-assembled, they only need to be opened up and secured to the foundation. They even have the positioning rail clamps pre-installed, so you don't need to measure and mark the rail positions anymore. The combination of these features is saving valuable time in assembly and logistics, making it one of the fastest system on the market.

Suitable for all soil and ground types

The support legs can be installed either with a concrete ballast footing or with ground screws. This makes STIII-A suitable for the most challenging soil conditions where ramming is not possible.

Simplicity

Sometimes bill of materials can be confusing and complicated. Not with Clenergy, on a BOM for STIII-A you will only find 6 components: support legs, rails, rail clamps, splices, mid and end clamps. Keeping it simple and transparent helps all parties to understand and work with the product better.

**10 Year
Warranty***

Commercial

Residential

Utility

**Available
accessories**

Grounding/earthing

Cable clips

Cable trays

Inverter/joint box bracket

Rail cap

PV-ezRack SolarTerrace III-A

ER-S-STIIIA



SolarTerrace III-A Support (pre-assembled)

- Back Leg
- N-Beam Joint
- S-Anchor Plate
- Enforcement Tube
- Hexagon Bolt M12 x 25mm (15/32"x 63/64")
- Lock Washer 12.4 (31/64")
- Flange Facing Nut M12 (15/32")
- Hexagon Bolt M12 x 90mm (15/32"x 3-35/64")
- Hexagon Bolt M12 x 80mm (15/32"x 3-5/32")
- Hexagon Nut M12 (15/32")
- Flat Washer 12.4 (34/64")
- Hexagon Nut M16 (5/8")
- Lock Washer 16.4mm (46/64")
- Flat Washer 16.4mm (46/64")
- N-anchor Plate
- Front Leg
- S-Beam Joint
- Tri Groove Beam

ER-IC-ST/U18



Inter Clamp, Standard

- Inter Module Clamp 28mm (1-7/64"), 35mm (1-3/8"), 40mm (1-37/64"), 46mm (1-13/16"), 50mm (1-31/32"), 57mm (2-1/4")
- 28mm (1-7/64") with Hex Socket Head Bolt A2-70 M8x40mm (5/16" x 1-37/64")
- 35mm (1-3/8") with Hex Socket Head Bolt A2-70 M8x45mm (5/16" x 1-49/64")
- 40mm (1-37/64") with Hex Socket Head Bolt A2-70 M8x50mm (5/16" x 1-31/32")
- 46mm (1-13/16") with Hex Socket Head Bolt A2-70 M8x55mm (5/16" x 2-11/64")
- 50mm (1-31/32") with Hex Socket Head Bolt A2-70 M8x60mm (5/16" x 2-23/64")
- 57mm (2-1/4") with Hex Socket Head Bolt A2-70 M8x70mm (5/16" x 2-3/4")
- Z-Module
- Lock Washer 8.4mm (21/64")

ER-EC-ST



End Clamp, Standard

- End Module Clamp 28mm (1-7/64"), 30mm (1-3/16"), 32mm (1-17/64"), 35mm (1-3/8"), 38mm (1-1/2"), 40mm (1-37/64"), 42mm (1-21/32"), 46mm (1-13/16"), 48mm (1-57/64"), 50mm (1-31/32"), 57mm (2-1/4")
- Z-Module
- Hex Socket Head Bolt A2-70 M8 x 28mm (5/16"x 1-1/10")
- Lock Washer 8.4mm (21/64")

ER-RC-T



Rail Clamp for T-Rail

- Rail Clamp 50 x 30 x 11.8mm (1-31/32" x 1-3/16" x 15/32")
- Hex Socket Head Bolt M8 x 30mm (5/16" x 1-3/16")
- Z-Module
- Spring Washer M8 (5/16")

ER-R-T110



T-Rail 110mm

- T-Rail 65 x 110mm (2-9/16" x 4-21/64")
- Length from 2000mm (6' 6-47/24") to 6100mm (20' 5/32")
- Standard Lengths 4200mm (13' 9-23/64") and 5200mm (17' 23/32")

ER-SP-T110



Splice for T-Rail 110

- Splice 45.7 x 105.6mm (1-51/64" x 4-1/15")
- Flange Face Self-Tapping Screw
- Self tapping screw M6.3 x 22mm (1/4" x 55/64")

ER-RC-T/A

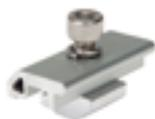

Positioning Rail Clamp for T-Rail

- Positioning Rail Clamp 50 x 27.25 x 11.5mm (1-5/64" x 1-5/64" x 29/64")
- Hex Socket Head Bolt M8 x 30mm (5/16" x 1-3/16")
- Spring Washer M8 (5/16")
- Z-Module

ER-RC-T/G



Rail Clamp for T-Rail with grounding/earthing pins

- Rail Clamp with pins 50 x 30 x 11.8mm (1-31/32" x 1-3/16" x 15/32")
- Hex Socket Head Bolt M8 x 30mm (5/16" x 1-3/16")
- Spring Washer M8 (5/16")
- Z-Module

PV-ezRack SolarTerrace V

Utility scale ground mount frame with time saving smart design

PV-ezRack SolarTerrace V is developed for utility scale PV-deployments with panels in landscape orientation. The system offers a wide range of adjustability, easy deployment and enables the implementation of large arrays. STV is a simple and robust structure so it can be installed even with untrained labour forces. All these features result in fast, easy and cost efficient installation. Main aluminium components have a standard 10µm anodisation.

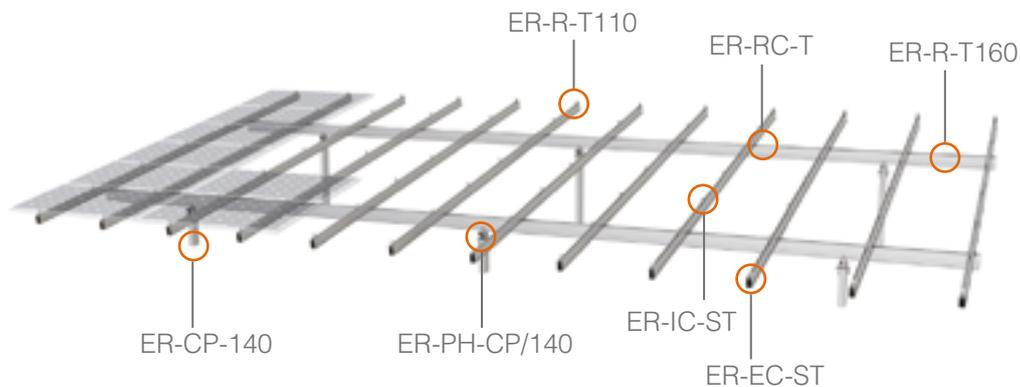

Main Benefits

Post-head adjustability

The smart design of the Post head provides adjustments in all directions to balance out inaccuracies which often occur through the nature of the ramming process. These generous adjustments allow easier and quicker installation.

Easy deployment

The connection between the main beams (Clipped T-rail 160) and the Post head is using special, spring supported rail clamps which easily slide and clip on to the bottom of the rail eliminating the often used and time consuming nut and bolt connection.

Utility optimised large arrays

STV is designed for utility scale applications and therefore offers large arrays, huge horizontal spans combined with up to 6 landscape panels (72 cells) in one row. Furthermore the design allows the panel rows to be pre-assembled to the rails off-site in controlled environment. All this saves valuable installation time on-site and increases efficiency during installation.

Simplicity

Sometimes bill of materials can be confusing and complicated. Not with Clenergy, on a basic BOM for STV you will only find 8 components. Keeping it simple and transparent helps all parties to understand and work with the product better.

**10 Year
Warranty***

Commercial

Residential

Available accessories

Grounding/earthing

Cable clips

Rail caps

Inverter/joint box bracket

PV-ezRack SolarTerrace V

ER-R-T160



Clipped T-Rail 160

- Clipped T-Rail 92 x 160mm (3-5/8" x 6-19/64")
- Length up to 6100mm (20' 5/32")

ER-SP-T160



Splice for Clipped T-Rail 160

- Splice for Clipped T-Rail 160
- Flange Face Self-Tapping Screw (with washer) ST6.3x22mm (1/4" x 55/64")

ER-CP-140



C-Post 140

- C-Post 70 x 140mm (2-3/4" x 5-33/64")

ER-PH-CP/140



Post Head for C post 140

- Mounting Base for Clipped T-160 Rail
- Rail clamp for Clipped T-160 Rail
- Snap-head bolt M8 x 40mm (5/16" x 1-37/64")
- Hexagon nut with flange M8 (5/16")
- Washer M8.5 x 20mm (21/34" x 25/32")
- ezClip Spring
- Corrugated shim
- Washer 12mm (15/32")
- Plain washer 12mm (15/32")
- Hexagon nut M12 (15/32")
- Bushing Ø18.5 x 35.5mm (47/64" x 1-25/64")
- Upper T-Head
- Hexagonal bolt M12 x 25mm (15/32" x 63/64")
- Lower T-Head
- Hexagonal bolt M12 x 110mm (15/32" x 4-21/64")

ER-PH-CP/140/EW



Post Head for C post 140/EW

- Mounting Base for Clipped T-160 Rail
- Rail clamp for Clipped T-160 Rail
- Snap-head bolt M8 x 40mm (5/16" x 1-37/64")
- Hexagon nut with flange M8 (5/16")
- Washer M8.5 x 20mm (21/34" x 25/32")
- ezClip Spring
- Corrugated shim
- Washer 12mm (15/32")
- Plain washer 12mm (15/32")
- Hexagon nut M12 (15/32")
- Bushing Ø18.5 x 35.5mm (47/64" x 1-25/64")
- Upper T-Head
- Hexagonal bolt M12 x 25mm (15/32" x 63/64")
- Lower T-Head
- Hexagonal bolt M12 x 110mm (15/32" x 4-21/64")

ER-CP-140A



C-Post 140A

- C-Post 70 x 140mm (2-3/4" x 5-33/64")

ER-R-T110



T-Rail 110mm

- T-Rail 65 x 110mm (2-9/16" x 4-21/64")
- Length from 2000mm (6' 6-47/24") to 6100mm (20' 5/32")
- Standard Lengths 4200mm (13' 9-23/64") and 5200mm (17' 23/32")

ER-IC-ST/U18



Inter Clamp, Standard

- Inter Module Clamp 28mm (1-7/64"), 35mm (1-3/8"), 40mm (1-37/64"), 46mm (1-13/16"), 50mm (1-31/32"), 57mm (2-1/4")
- 28mm (1-7/64") with Hex Socket Head Bolt A2-70 M8x40mm (5/16" x 1-37/64")
- 35mm (1-3/8") with Hex Socket Head Bolt A2-70 M8x45mm (5/16" x 1-49/64")
- 40mm (1-37/64") with Hex Socket Head Bolt A2-70 M8x50mm (5/16" x 1-31/32")
- 46mm (1-13/16") with Hex Socket Head Bolt A2-70 M8x55mm (5/16" x 2-11/64")
- 50mm (1-31/32") with Hex Socket Head Bolt A2-70 M8x60mm (5/16" x 2-23/64")
- 57mm (2-1/4") with Hex Socket Head Bolt A2-70 M8x70mm (5/16" x 2-3/4")
- Z-Module
- Lock Washer 8.4mm (21/64")

ER-EC-ST



End Clamp, Standard

- End Module Clamp 28mm (1-7/64"), 30mm (1-3/16"), 32mm (1-17/64"), 35mm (1-3/8"), 38mm (1-1/2"), 40mm (1-37/64"), 42mm (1-21/32"), 46mm (1-13/16"), 48mm (1-57/64"), 50mm (1-31/32"), 57mm (2-1/4")
- Z-Module
- Hex Socket Head Bolt A2-70 M8 x 28mm (5/16" x 1-1/10")
- Lock Washer 8.4mm (21/64")

ER-RC-T



Rail Clamp for T-Rail

- Rail Clamp 50 x 30 x 12.3mm (1-31/32" x 1-3/16" x 31/64)
- Hex Socket Head Bolt M8 x 30mm (5/16" x 1-3/16")
- Z-Module

ER-RC-T/G



Rail Clamp for T-Rail with grounding/earthing pins

- Rail Clamp with pins 50 x 30 x 11.8mm (1-31/32" x 1-3/16" x 15/32")
- Hex Socket Head Bolt M8 x 30mm (5/16" x 1-3/16")
- Spring Washer M8 (5/16")
- Z-Module

PV-ezRack ThinFilm

ER-R-TFT



ThinFilm Triangle Rail

- Triangle Rail
- Rubber Pad

ER-R-TF



ThinFilm Rail

- Film Rail
- Rubber Pad

ER-SP-TFT



Splice for ThinFilm Triangle Rail

- Triangle Splice
- Self tapping screw

ER-SP-TF



Splice for ThinFilm Rail

- Splice for ThinFilm Rail
- Hexagon socket head Bolt
M8 x 20mm (5/16" x 25/32")

ER-RC-TFT



Rail Clamp, for ThinFilm Triangle Rail

- Fixture Block
- Z-module
- Hex Socket Head Bolt
M8 x 40mm (5/16" x 1-37/64")

ER-IC-TF



Inter Clamp, ThinFilm

- Middle Cap
- Main Clasp/Claw
- Clasp/Claw
- Force Spring
- Rubber Pad
- Hex Socket Head Bolt
M8 x 18mm (5/16" x 45/64")
- Spring

ER-EC-TF



End Clamp, ThinFilm

- Middle Cap
- Main Clasp/Claw
- Clasp/Claw
- Force Spring
- Rubber Mat
- Hex Socket Head Bolt
M8 x 18mm (5/16" x 45/64")
- Spring

ER-EC-FL/5



End Clamp for 5mm Frameless Module, Length 80,120,150 and 200mm

- Laminate End Clamp-Upper Part, for Unframed Height 5mm
- Laminate End Clamp-Lower Part, for Unframed Height 5mm
- Upper Rubber Pad
- Lower Rubber Pad
- Washer 8
- Hexagon Socket Head Bolt
M8 x 35mm (1-3/8")
- Z-Module

ER-IC-FL/5



Inter Clamp for 5mm Frameless Module, Length 80,120,150 and 200mm

- Laminate Inter Clamp-Upper Part, for Unframed Height 5mm
- Laminate Inter Clamp-Lower Part, for Unframed Height 5mm
- Upper Rubber Pad
- Lower Rubber Pad
- Washer 8
- Hexagon Socket Head Bolt
M8 x 35mm (1-3/8")
- Z-Module

ER-EC-FL/6.8



End Clamp, Laminate, for Unframed Height 6.8mm (17/64")

- Laminate End Clamp-Upper Part, for Unframed Height 6.8mm
- Laminate End Clamp-Lower Part, for Unframed Height 6.8mm
- Upper Rubber Pad
- Lower Rubber Pad
- Washer 8
- Hexagon Socket Head Bolt
M8 x 35mm (1-3/8")
- Z-Module

ER-IC-FL/6.8



Inter Clamp, Laminate, for Unframed Height 6.8mm (17/64")

- Laminate Inter Clamp-Upper Part, for Unframed Height 6.8mm
- Laminate Inter Clamp-Lower Part, for Unframed Height 6.8mm
- Upper Rubber Pad
- Lower Rubber Pad
- Washer 8
- Hexagon Socket Head Bolt
M8 x 35mm (1-3/8")
- Z-Module

Accessories

Accessories - Earthing / Grounding components

EZ-GL-ST



Grounding Lug (standard)

- Grounding Lug L25
- Hexagon Socket Head Bolt M8 x 25mm (5/16" x 63/64")
- Z-Mouldle L20
- Spring Washer M8.4 (21/64")
- Flat Washer M8.4 (21/64")
- Grounding Lug Bolt M6 x 14mm (3/16" x 35/64")

EZ-GC-ST



Grounding Clamp (standard)

Accessories - Cable clips and trays

EZ-CC-R/ST/6



Cable Clip for ST- and PRO-Rail - hold up to 6 cables

EZ-CC-PV/2



Universal Cable Clip for PV Panels for holding 2 cables

- Universal Cable Clip for PV Panels for holding 2 cables

EZ-CC-PV/4



Universal Cable Clip for PV Panels for holding 4 cables

- Universal Cable for PV Panels for holding 4 cables 31.6 x 18.2 x T0.5mm (1-1/4" x 23/32" x T1/64")

EZ-C-CD/T



Clamp for Cable Duct on T-Rail

- Clamp for Cable Duct on T-rail
- T-head bolt M8 x 25mm (5/16" x 63/64")
- Plain washer 8mm (5/16")
- Washer 8mm (5/16")
- Hexagon nut M8 (5/16")
- Set screw M8 x 12mm (5/16" x 15/32")

EZ-CD-102



Cable Duct 102

EZ-CO-CD/102



Cover for Cable Duct 102

Accessories - Rail caps

EZ-CAP-ST



Cap for Standard Rail

EZ-CAP-B



Cap for B-Shape Rail

ER-CAP-G/A



Cap for Square Girder

EZ-CAP-T50



Cap for T-Rail 50

- Cap for T50 Rail 54.5 x 50mm (2-9/64" x 1-31/32")

ER-CAP-T110



Cap for T-Rail 110

Accessories

Accessories - Brackets for inverter / combiner box

EZ-UB-STIIIA



SolarTerrace III-A, Bracket kit for Inverter / Combiner Box

- U-Fixing Bracket for Tube 60 x 60mm (2-23/64" x 2-23/64")
- T-head bolt M8 x 25mm (5/16" x 63/64")
- Plain washer large 8 x 24mm (5/16" x 53/64")
- Washer 8mm (5/16")
- Hexagon nut M8 (5/16")
- Self-drilling screw ST6.3 x 25mm (1/4" x 63/64")

EZ-UB-STIIA



SolarTerrace II-A, Bracket kit for Inverter / Combiner Box

- U-Fixing Bracket for Tube 60 x 60mm (2-23/64" x 2-23/64")
- T-head bolt M8 x 25mm (5/16" x 63/64")
- Plain washer large 8 x 24mm (5/16" x 53/64")
- Washer 8mm (5/16")
- Hexagon nut M8 (5/16")

EZ-RT-60/60/740



Slotted Al-Tube for Bracket kit for Inverter / Combiner Box

- Slotted Al-Tube 60 x 60 x 740mm (2-23/64" x 2-23/64" x 2' 1-13/64")

ER-R-C41/61/800



C-Channel for Bracket kit for Inverter / Combiner Box

- 41 x 62 x 800mm (1-39/64" x 2-7/16" x 2' 7-1/2")

Accessories - Rubber pads

EZ-RB-65/45/12

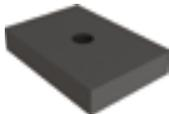

EPDM rubber pad

- EPDM rubber pad 65 x 45 x 12mm (2-9/16" x 1-49/64" x 15/32")

EZ-RB-ST



Rubber Pad

- 50 x 25 x 2.2mm (1-31/32" x 63/64" x 3/32")

EZ-RB-65/20000/2



EPDM strip

- EPDM strip 65 x 20000 x 2mm (2-9/16" x 65' 7-13/32" x 5/64")

Accessories - Other

EZ-AD-C110



SolarRoof Adapter for Corrugated Iron Roof

- AL Adapter 110mm x 124mm (4-21/64" x 4-7/8")
- EPDM rubber pad
- Z-Module and bolt

EZ-CD-102



Isolator Bracket

- Isolator Bracket
- Hexagon Socket Head Bolt M8 x 25mm (5/16" x 63/64")
- Z Module L20
- Spring Washer M8 (5/16")
- Flat Washer M8 (5/16")

EZ-AD-GSS76/CP140



Adapter between Ground screw S76 and C-Post 140

- U-Profile Bracket
- Arc Fixed Block
- Hexagonal bolt M12 x 120mm (15/32" x 5-1/64")
- Washer 12mm (15/32")
- Plain washer 12mm (15/32")
- Hexagon nut M12 (15/32")

EZ-RE-200



Roof Hook Extender

- 200mm Roof Hook Extender
- Hex Socket Head Bolt
- Hex Nut

ER-R-MT/2560



MT-rail

- With a standard length of 2560mm (8' 4-25/32")

EZ-Z-STBW



Z-Module assembly with bolt and washer

- Z-Module
- M8 x 25mm (5/16" x 63/64") A2 70
- Washer 8.4mm (21/64") DIN 9021 A2
- Lock Washer 8mm (5/16") A2

ER-DM-MT8



Diamond module M8 with Hexagon Socket bolt M8x20 (for AU)

EZ-Z-ST



Z-Module



Worldwide network



Clenergy America

5755 Oberlin Drive, Suite 328, San Diego CA 92121
Tel: +1 858 790 8066

E-mail: sales@clenergy.us www.clenergy.us

Clenergy Australia

Unit 11, 20 Duerdin St, Clayton VIC 3168, Australia
Tel: +61 3 9239 8088 Fax: +61 3 9239 8024

E-mail: sales@clenergy.com.au www.clenergy.com.au

Clenergy China

999-1009 Min'an Rd, Huoju Hi-tech Ind. Dev. Zone
Xiang'an District 361101, Xiamen, Fujian, China

Tel: +86 592 311 0088 Fax: +86 592 599 5028
E-mail: sales@clenergy.com.cn www.clenergy.com.cn

Clenergy Europe

Clenergy Court, Blisworth Hill Farm Stoke Road, Blisworth
Northampton, NN7 3DB, UK

Tel: +44 1604 857 674 Fax: +44 1604 858 620
E-mail: sales_uk@clenergy.com www.clenergy.uk.com

Clenergy Japan

SOHO STATION 401, 24-8 Yamashita-cho, Naka-ku
Yokohama, 231-0023 Japan

Tel: +81 45 228 8226 Fax: +81 45 228 8316
E-mail: sales@clenergy.co.jp www.clenergy.jp

Clenergy Malaysia (Regional Office)

Suite 8.01, Level 8, Menara IGB, Mid Valley City
Lingkaran Syed Putra, 59200, Kuala Lumpur, Malaysia

Tel: +60 3 2202 4268 Fax: +60 3 2202 4001
E-mail: sales@clenergy.my www.clenergy.my



**10 Year
Warranty***