

## HNS026RB OWNER'S MANUAL

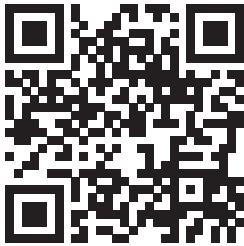

Scan our QR code with your phone to go directly to our website for technical information



The HNS026RB Remote Button enables multi-way dimming and ON/OFF with the S-Click Digital Dimmers™ HNS616DT and HNS626DT or multi-way ON/OFF with the S-Click 3-Wire timer switches HNS446TM and HNS456TM.

An inbuilt LED indicator can be configured two ways by connecting Neutral to the HNS026RB. The LED indicator can be permanently ON, or ON while the button is pressed. The HNS026RB will operate without neutral connected but the LED indicator will not function.

Multiple HNS026RB can be connected in parallel to a single dimmer or a single 3-wire timer provided the total length of the remote connection does not exceed 50 metres.

### 1. FEATURES

- Multi-way dimming and ON/OFF switching for S-Click Digital Dimmers.
- Multi-way ON/OFF switching for S-Click 3-Wire Timer range.
- Suits HNS616DT and HNS626DT Digital Dimmers™ only.
- Suits HNS446TM and HNS456TM timers and switches only.
- Neutral not required for button only operation.
- Optional LED Indicator operation requires Neutral.
- Suits CABAC, Clipsal and HPM stype wall plates.
- NOT FOR MAINS SWITCHING.

### 2. OPERATING CONDITIONS

- Operating Voltage: 220 - 240Va.c. 50Hz
- Operating Temperature: 0 to +50 °C
- Compliance Standard: AS/NZS 60669.2.1, CISPR15
- Power Rating: Based upon connected Dimmer or Timer

Note: Operation at temperature, voltage or load outside of the specifications may cause permanent damage to the unit.

### 3. LOAD COMPATIBILITY

- S-Click Digital Dimmers™: HNS616DT and HNS626DT.
- S-Click Timers and Switches: HNS446TM and HNS456TM.

### 4. INSTALLATION INSTRUCTIONS

**WARNING:** The HNS026RB Remote Button is to be installed as part of a fixed wire electrical installation. By law such installations must be made by an electrical contractor or similarly qualified person.

- **Single Core: 50m** (connect Active and Neutral (if required) locally provided they are on the same phase as the dimmer or timer).
- **Twin Core: 20m** ( if the remote does not fully function or there is false switching, only connect the Remote through the twin, and connect Active and Neutral (if required) locally provided they are on the same phase as the dimmer or timer).

Note: This manual was correct at the time of manufacture. For the latest version of the manual and any technical or safety updates refer to the website [www.sclick.com.au](http://www.sclick.com.au) or scan the QR code with a mobile phone.

## 4.1 WIRING

- Disconnect power at the circuit breaker before any electrical work.
- Clip the button on to the HNS026RB. Ensure that the button is oriented so that the LED light pipe is aligned with the hole in the button, before attaching it to the wall plate. Refer to Figure 1 and 2 below.
- Reconnect power at the circuit breaker and affix Solid State Device Warning Sticker at switchboard.

NOTE: The HNS026RB is designed for indoor use. It is not rated for outdoor installation.

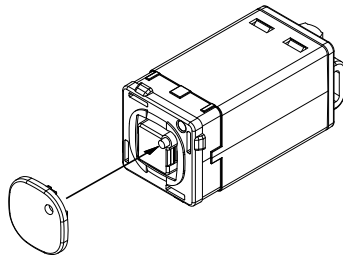

Fig 1: Installing Button to unit

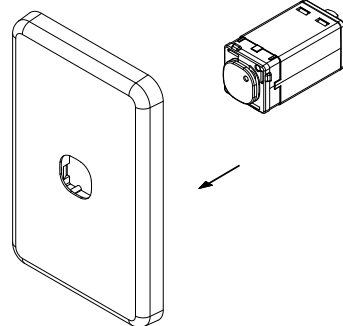

Fig 2: Attaching unit to wall plate

## 4.2 WIRING FOR LED AND BUTTON OPERATION - NEUTRAL PRESENT

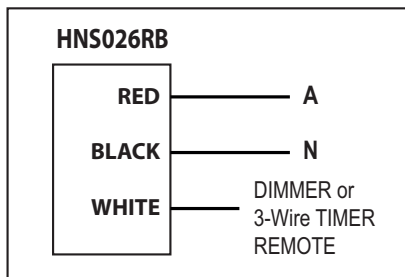

Fig 3: LED Indicator always ON

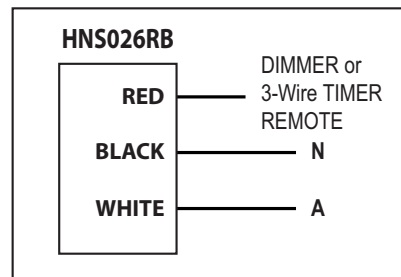

Fig 4: LED Indicator ON with button press

## 4.2 WIRING FOR BUTTON ONLY OPERATION - NO NEUTRAL REQUIRED

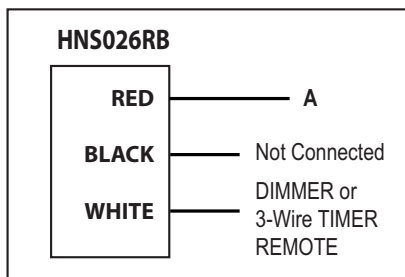

Fig 5: Button only operation

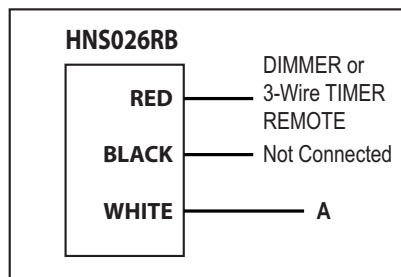

Fig 6: Button only operation

## 5. IMPORTANT SAFETY WARNINGS

### 5.1 LOW READING DURING INSULATION BREAKDOWN TEST

- The HNS026RB is a solid state device. Therefore a low reading may be observed when conducting insulation breakdown testing on the circuit.

### 5.2 CLEANING

- Clean only with a damp cloth. Do not use abrasives or chemicals.

## 6. WARRANTY AND DISCLAIMER

Legend Corporation Limited warrants the product against manufacturing and material defect from the date of invoice to the initial purchaser for a period of 12 months. During the warranty period Legend Corporation Limited will replace products that prove to be defective where the product has been correctly installed and maintained and operated within the specifications defined in the product data sheet and where the product is not subject to mechanical damage or chemical attack. The warranty is also conditional on the unit being installed by a licensed electrical contractor. No other warranty is expressed or implied. Legend Corporation Limited shall not be liable for any direct, indirect, incidental or consequential damages.