

MESWC
MESWCFAN
MESWCHEAT
MESWCLIGHT
MESW32C
MESW32COVEN
MESW32CHOB
MESWCI
MESWCDP
MESWCBPR
MESWC3*

MESWC (Cat's Eye) switch mechanism are used in conjunction with Snow Leopard, Clouded Leopard, Leopard and Cheetah switch plates

Note: MESW switch mechanism are used in conjunction with Flat Cat, Puma and Cougar switch plates.

*Multiple print options available - see catalogue or website for further detail.

Cleaning Guide:

Spraying cleaning products on to electrical products is not recommended.

It is important to ensure that switches are turned off before cleaning.

Do not use any cleaning sprays - only wipe down with damp cloth or rub with dry cloth. (Do not use an abrasive cloth as it may scratch the plastic).

Do not use harsh chemical cleaners as these can break down the plastic and cause it to crack.



Meerkat Range of Switch Mechanisms

For use in conjunction with SNOW LEOPARD, CLOUDED LEOPARD and LEOPARD

- MESWC (was LESWM) - approved to AS/NZS60669-1.
- MESW32C (was LESW32M) and MESW32COVEN (was LESWOV32M) approved to AS/NZS3133.
- Designed to clip into Snow Leopard, Clouded Leopard and Leopard switch plates, also fits all Trader Ranges and many others.
- Uses brass tunnel terminal that have the screws backed out for easier installation of cabling. Switches are single pole two way with looping terminal and suit 4 x 1.5mm² cables with 4.1mm bore.
- Slotted head terminal screws, and backed out for easy installation.
- Cat's Eye dolly styling.
- Covers, plates and dollies are made from UV stabilised polycarbonate to avoid discolouring to yellow.
- Please check availability.



Catalogue Number	Description
MESWC	Switch Mechanism 16AX/20A 250V~ Cat's Eye
MESWCFAN	Switch Mechanism 16AX/20A 250V~ Cat's Eye (Labelled Fan)
MESWCHEAT	Switch Mechanism 16AX/20A 250V~ Cat's Eye (Labelled Heat)
MESWCLIGHT	Switch Mechanism 16AX/20A 250V~ Cat's Eye (Labelled Light)
MESW32C	Switch Mechanism 32A 250V~ Cat's Eye
MESW32COVEN	Switch Mechanism 32A 250V~ Cat's Eye (Labelled Oven)
MESW32CHOB	Switch Mechanism 32A 250V~ Cat's Eye (Labelled Hob)
MESWCI	Intermediate Switch Mechanism 10AX 250V~ Cat's Eye
MESWCDP	Double Pole Switch Mechanism 10AX 250V~ Cat's Eye
MESWCBPR	Switch Mechanism Bell Press Return 10AX/16A 250V Cats Eye
MESWC3	Switch Mechanism 3-Position 10AX 250V~ Cat's Eye

- For colours and finishes see Meerkat Rocker Matrix on following pages.
- Colours available: White (Standard), Black (BK), Matt White (MW), Matt Black (MBK) and Silver (SV). Check for availability.

The MEERKAT Switch Mechanism (MESWC) was previously (LESWM) and is universal to all Snow Leopard, Clouded Leopard, Leopard and Cheetah switch plates.

SNOW LEOPARD  CLOUDED LEOPARD  LEOPARD 

Certification Number: MESWC: GMA-103194-EA-011 /
MESW32C: GMA-508325 / GMA-501682 / GMA-507879-EA

GSM Electrical (Australia) Pty Ltd

Level 2, 142-144 Fullarton Road, Rose Park SA 5067
P: 1300 301 838 F: 1300 301 778 E: service@gsm.com.au
www.gsm.com.au



MESW
MESWFAN
MESWHEAT
MESWLIGHT
MESW20
MESW32
MESW32OVEN
MESW32HOB
MESWI
MESWDP
MESWBPR
MESWDP20
MESWDP20HOB
MESWDP20OVEN
MESW3*

MESW switch mechanism are used in conjunction with Flat Cat, Puma and Cougar switch plates

Note: MESWC (Cat's Eye) switch mechanism are used in conjunction with Snow Leopard, Leopard and Cheetah switch plates

*Multiple print options available - see catalogue or website for further detail.

Cleaning Guide:

Spraying cleaning products on to electrical products is not recommended. It is important to ensure that switches are turned off before cleaning. Do not use any cleaning sprays - only wipe down with damp cloth or rub with dry cloth. (Do not use an abrasive cloth as it may scratch the plastic). Do not use harsh chemical cleaners as these can break down the plastic and cause it to crack.



Meerkat Range of Rocker Switch Mechanisms

For use in conjunction with *FLAT CAT, PUMA and COUGAR*

- MESW (was COSWM) - approved to AS/NZS3133.
- Designed to clip into Flat Cat, Puma and Cougar switch plates, also fits all Trader Ranges and many others.
- Uses brass tunnel terminal that have the screws backed out for easier installation of cabling. Switches are single pole two way with looping terminal and suit 4 x 1.5mm² cables with 4.1mm bore.
- Slotted head terminal screws, and backed out for easy installation.
- Covers, plates and dollies are made from UV stabilised polycarbonate to avoid discolouring to yellow.
- Please check availability.



Catalogue Number	Description
MESW	Switch Mechanism 10AX/16A 250V~
MESWFAN	Switch Mechanism 10AX/16A 250V~ (Labelled Fan)
MESWHEAT	Switch Mechanism 10AX/16A 250V~ (Labelled Heat)
MESWLIGHT	Switch Mechanism 10AX/16A 250V~ (Labelled Light)
MESW20	Switch Mechanism 16AX/20A 250V~
MESW32	Switch Mechanism 32A 250V~
MESW32OVEN	Switch Mechanism 32A 250V~ (Labelled Oven)
MESW32HOB	Switch Mechanism 32A 250V~ (Labelled Hob)
MESWI	Intermediate Switch Mechanism 10AX 250V~
MESWBPR	Switch Mechanism Bell Press Return 10AX/16A 250V~
MESWDP	Double Pole Switch Mechanism 10AX 250V~
MESWDP20	Double Pole Switch Mechanism 20A 250V~
MESWDP20HOB	Double Pole Switch Mechanism 20A 250V~ (Labelled Hob)
MESWDP20OVEN	Double Pole Switch Mechanism 20A 250V~ (Labelled Oven)
MESW3	Switch Mechanism 3-Position 10AX 250V~

- For colours and finishes see Meerkat Rocker Matrix on following pages.
- Colours available: White (Standard), Black (BK), Matt White (MW), Matt Black (MBK) and Green (G). Check for availability.

The MEERKAT Rocker Switch Mechanism (MESW) was previously (COSWM) and is universal to all Flat Cat, Puma and Cougar switch plates.

FLAT CAT  **PUMA**  **COUGAR** 

Certification Number: MESW: GMA-501682-EA / GMA-501835-EA / GMA-508487-EA MESWBPR: GMA-508434-EA

GSM Electrical (Australia) Pty Ltd
Level 2, 142-144 Fullarton Road, Rose Park SA 5067
P: 1300 301 838 F: 1300 301 778 E: service@gsme.com.au
www.gsme.com.au





PART NO.	DESCRIPTION	SNOW LEOPARD	CLOUDED LEOPARD	LEOPARD	FLAT CAT	PUMA	COUGAR
MESWC	Switch Mechanism 16AX/20A 250V~	✓		✓			
MESWCBK	Switch Mechanism 16AX/20A 250V~ Cat's Eye Black	✓		✓			
MESWCMW	Switch Mechanism 16AX/20A 250V~ Cat's Eye Matt White		✓				
MESWCMBK	Switch Mechanism 16AX/20A 250V~ Cat's Eye, Matt Black		✓				
MESWCSV	Switch Mechanism 16AX/20A 250V~ Cat's Eye Silver	✓					
MESWCFAN	Switch Mechanism 16AX/20A 250V~ Cat's Eye (Labelled Fan)	✓		✓			
MESWCHEAT	Switch Mechanism 16AX/20A 250V~ Cat's Eye (Labelled Heat)	✓		✓			
MESWCLIGHT	Switch Mechanism 16AX/20A 250V~ Cat's Eye (Labelled Light)	✓		✓			
MESW32C	Switch Mechanism 32A 250V~ Cat's Eye	✓		✓			
MESW32CBK	Switch Mechanism 32A 250V~ Cat's Eye Black	✓		✓			
MESW32CMW	Switch Mechanism 32A 250V~ Cat's Eye, Matt White		✓				
MESW32CMBK	Switch Mechanism 32A 250V~ Cat's Eye, Matt Black		✓				
MESW32CSV	Switch Mechanism 32A 250V~ Cat's Eye, Silver	✓					
MESW32COVEN	Switch Mechanism 32A 250V~ Cat's Eye (Labelled Oven)	✓		✓			
MESW32CHOB	Switch Mechanism 32A 250V~ Cat's Eye (Labelled HOB)	✓		✓			
MESWCI	Intermediate Switch Mechanism 10AX 250V~ Cat's Eye	✓		✓			
MESWCIBK	Intermediate Switch Mechanism 10AX 250V~ Cat's Eye Black	✓		✓			
MESWCIMW	Intermediate Switch Mechanism 10AX 250V~ Cat's Eye, Matt White		✓				
MESWCIMBK	Intermediate Switch Mechanism 10AX 250V~ Cat's Eye, Matt Black		✓				
MESWCISV	Intermediate Switch Mechanism 10AX 250V~ Cat's Eye Silver	✓					
MESWCDP	Double Pole Switch Mechanism 10AX 250V~ Cat's Eye	✓		✓			
MESWCDPBK	Double Pole Switch Mechanism 10AX 250V~ Cat's Eye, Black	✓		✓			
MESWCDCPMW	Double Pole Switch Mechanism 10AX 250V~ Cat's Eye, Matt White		✓				
MESWCDCPMBK	Double Pole Switch Mechanism 10AX 250V~ Cat's Eye, Matt Black	✓	✓				
MESWCDCPSV	Double Pole Switch Mechanism 10AX 250V~ Cat's Eye Silver	✓					

ALL GREEN BASED MECHS ARE 16AX/20AMP STANDARD



ME = Meerkat

SW = Switch

C = Cat's Eye

BK = Black

MW= Matt White

MBK = Matt Black

SV = Silver



PART NO.	DESCRIPTION	SNOW LEOPARD	CLOUDED LEOPARD	LEOPARD	FLAT CAT	PUMA	COUGAR
MESWC3	Switch Mechanism 3-Position 10AX 250V~ Cat's Eye	✓		✓			
MESWC3BK	Switch Mechanism 3-Position 10AX 250V~ Cat's Eye, Black	✓		✓			
MESWC3MW	Switch Mechanism 3-Position 10AX 250V~ Cat's Eye, Matt White		✓				
MESWC3MBK	Switch Mechanism 3-Position 10AX 250V~ Cat's Eye, Matt Black		✓				
MESWC3AOM	Switch Mechanism 3-Position 10AX 250V~ Cat's Eye AUTO/OFF/MAN	✓		✓			
MESWC3AOMBK	Switch Mechanism 3-Position 10AX 250V~ Cat's Eye AUTO/OFF/MAN, Black	✓		✓			
MESWC3AOMMW	Switch Mechanism 3-Position 10AX 250V~ Cat's Eye AUTO/OFF/MAN, Matt White		✓				
MESWC3AOMMBK	Switch Mechanism 3-Position 10AX 250V~ Cat's Eye AUTO/OFF/MAN, Matt Black		✓				
MESWC3S00	Switch Mechanism 3-Position 10AX 250V~ Cat's Eye SENSOR/OFF/ON	✓		✓			
MESWC3S00BK	Switch Mechanism 3-Position 10AX 250V~ Cat's Eye SENSOR/OFF/ON, Black	✓		✓			
MESWC3S00MW	Switch Mechanism 3-Position 10AX 250V~ Cat's Eye SENSOR/OFF/ON, Matt White		✓				
MESWC3S00MBK	Switch Mechanism 3-Position 10AX 250V~ Cat's Eye SENSOR/OFF/ON, Matt Black		✓				
MESWC3UOD	Switch Mechanism 3-Position 10AX 250V~ Cat's Eye UP/OFF/DOWN	✓		✓			
MESWC3U0DBK	Switch Mechanism 3-Position 10AX 250V~ Cat's Eye UP/OFF/DOWN, Black	✓		✓			
MESWC3U0DMW	Switch Mechanism 3-Position 10AX 250V~ Cat's Eye UP/OFF/DOWN, Matt White		✓				
MESWC3U0DMBK	Switch Mechanism 3-Position 10AX 250V~ Cat's Eye UP/OFF/DOWN, Matt Black		✓				
MESWCBPR	Switch Mechanism Bell Press Return 10AX/16A 250V~ Cat's Eye	✓		✓			
MESWCBPRBK	Switch Mechanism Bell Press Return 10AX/16A 250V~ Cat's Eye, Black	✓		✓			
MESWCBPRMW	Switch Mechanism Bell Press Return 16AX/20A 250V~ Cat's Eye, Matt White		✓				
MESWCBPRMBK	Switch Mechanism Bell Press Return 16AX/20A 250V~ Cat's Eye, Matt Black		✓				

ME = Meerkat

SW = Switch

C = Cat's Eye

BK = Black





MW= Matt White

MBK = Matt Black

SV = Silver





PART NO.	DESCRIPTION	SNOW LEOPARD	CLOUDED LEOPARD	LEOPARD	FLAT CAT	PUMA	COUGAR
 MESW	Switch Mechanism 10AX/16A 250V~				✓	✓	✓
 MESWBK	Switch Mechanism 10AX/16A 250V~ Black				✓	✓	
 MESWMW	Switch Mechanism 10AX/16A 250V~ Matt White				✓		
 MESWMBK	Switch Mechanism 10AX/16A 250V~ Matt Black				✓		
 MESWFAN	Switch Mechanism 16A 250V~ (Labelled Fan)				✓	✓	✓
 MESWHEAT	Switch Mechanism 16A 250V~ (Labelled Heat)				✓	✓	✓
 MESWLIGHT	Switch Mechanism 16A 250V~ (Labelled Light)				✓	✓	✓
 MESWGR	Switch Mechanism 10AX/16A 250V~ Green				✓	✓	✓
 MESW20	Switch Mechanism 16AX/20A 250V~				✓	✓	✓
 MESW20BK	Switch Mechanism 16AX/20A 250V~ Black				✓		
 MESW20MW	Switch Mechanism 16AX/20A 250V~ Matt White				✓	✓	
 MESW20MBK	Switch Mechanism 16AX/20A 250V~ Matt Black				✓		
 MESWDP20	Double Pole Switch Mechanism 20A 250V~				✓	✓	✓
 MESWDP20BK	Double Pole Switch Mechanism 20A 250V~ Black				✓	✓	
 MESWDP20HOB	Double Pole Switch Mechanism 20A 250V~ (Labelled HOB)				✓	✓	✓
 MESWDP20HOB BK	Double Pole Switch Mechanism 20A 250V~ (Labelled HOB) Black				✓	✓	
 MESWDP20OVEN	Double Pole Switch Mechanism 20A 250V~ (Labelled OVEN)				✓	✓	✓
 MESWDP20OVEN BK	Double Pole Switch Mechanism 20A 250V~ (Labelled OVEN) Black				✓	✓	
 MESW32	Switch Mechanism 32A 250V~				✓	✓	
 MESW32BK	Switch Mechanism 32A 250V~ Black				✓	✓	
 MESW32MW	Switch Mechanism 32A 250V~ Matt White				✓		
 MESW32MBK	Switch Mechanism 32A 250V~ Matt Black				✓		
 MESW32OVEN	Switch Mechanism 32A 250V~ (Labelled Oven)				✓	✓	✓
 MESW32HOB	Switch Mechanism 32A 250V~ (Labelled HOB)				✓	✓	✓

ALL GREEN BASED MECHS ARE 16AX/20AMP STANDARD



ME = Meerkat SW = Switch C = Cat's Eye BK = Black MW = Matt White MBK = Matt Black SV = Silver G = Green



PART NO.	DESCRIPTION	SNOW LEOPARD	CLOUDED LEOPARD	LEOPARD	FLAT CAT	PUMA	COUGAR
MESWI	Intermediate Switch Mechanism 10AX 250V~				✓	✓	✓
MESWIBK	Intermediate Switch Mechanism 10AX 250V~ Black				✓	✓	
MESWIMW	Intermediate Switch Mechanism 10AX 250V~ Matt White				✓		
MESWIMBK	Intermediate Switch Mechanism 10AX 250V~ Matt Black				✓		
MESWDP	Double Pole Switch Mechanism 10AX 250V~				✓	✓	✓
MESWDPBK	Double Pole Switch Mechanism 10AX 250V~ Black				✓	✓	
MESWDPMW	Double Pole Switch Mechanism 10AX 250V~ Matt White				✓		
MESWDPMBK	Double Pole Switch Mechanism 10AX 250V~ Matt Black				✓		
MESW3	Switch Mechanism 3-Position 10AX 250V~				✓	✓	✓
MESW3BK	Switch Mechanism 3-Position 10AX 250V~ Black				✓	✓	
MESW3MW	Switch Mechanism 3-Position 10AX 250V~ Matt White				✓		
MESW3MBK	Switch Mechanism 3-Position 10AX 250V~ Matt Black				✓		
MESW3AOM	Switch Mechanism 3-Position 10AX 250V~ AUTO/OFF/MAN				✓	✓	✓
MESW3AOMBK	Switch Mechanism 3-Position 10AX 250V~ AUTO/OFF/MAN, Black				✓	✓	
MESW3AOMMW	Switch Mechanism 3-Position 10AX 250V~ AUTO/OFF/MAN, Matt White				✓		
MESW3AOMMBK	Switch Mechanism 3-Position 10AX 250V~ AUTO/OFF/MAN, Matt Black				✓		
MESW3SOO	Switch Mechanism 3-Position 10AX 250V~ SENSOR/OFF/ON				✓	✓	✓
MESW3SOOBK	Switch Mechanism 3-Position 10AX 250V~ SENSOR/OFF/ON, Black				✓	✓	
MESW3SOOMW	Switch Mechanism 3-Position 10AX 250V~ SENSOR/OFF/ON, Matt White				✓		
MESW3SOOMBK	Switch Mechanism 3-Position 10AX 250V~ SENSOR/OFF/ON, Matt Black				✓		
MESW3UOD	Switch Mechanism 3-Position 10AX 250V~ UP/OFF/DOWN				✓	✓	✓
MESW3UODBK	Switch Mechanism 3-Position 10AX 250V~ UP/OFF/DOWN, Black				✓	✓	
MESW3UODMW	Switch Mechanism 3-Position 10AX 250V~ UP/OFF/DOWN, Matt White				✓		
MESW3UODMBK	Switch Mechanism 3-Position 10AX 250V~ UP/OFF/DOWN, Matt Black				✓		
MESWBPR	Switch Mechanism Bell Press Return 10AX/16A 250V~				✓	✓	✓
MESWBPRBK	Switch Mechanism Bell Press Return 10AX/16A 250V~ Black				✓	✓	
MESWBPRMW	Switch Mechanism Bell Press Return 10AX/16A 250V~ Matt White				✓		
MESWBPRMBK	Switch Mechanism Bell Press Return 10AX/16A 250V~ Matt Black				✓		

**MENRD
MENGR
MENOR
MENRD24
MENGR24
MENOR24**

*See current catalogue for further detail

Cleaning Guide:

Spraying cleaning products on to electrical products is not recommended. It is important to ensure that switches are turned off before cleaning.

Do not use any cleaning sprays - only wipe down with damp cloth or rub with dry cloth. (Do not use an abrasive cloth as it may scratch the plastic).

Do not use harsh chemical cleaners as these can break down the plastic and cause it to crack.



Meerkat Range of Neon Mechs

- Colours available are Green, Orange (Amber) and Red.
- Neons draw approximately 250-275mW at 250V.
- Neutral and Active can be connected to either terminal.
- Terminal bores of 4.1mm \varnothing accommodate 4 x 1.5mm² or 3 x 2.5mm² cables
- Note: Inductive loads occasionally cause neons to glow in OFF position. To overcome this, place a 47k Ω , 0.5W 240V resistor across the terminals.
- 24 Volt neons are also available in the same colours and housings and are suitable for specific load signaling applications.
- Identification for 250V shown on lens.
- 24V version shows 24V on lens as well as large label on base for identification.
- Neons can operate in both a.c. or d.c. conditions.



MENRD



MENGR



MENOR



MENOR24

Catalogue Number	Description
MENRD	Neon Indicator Mechanism 250V Red
MENGR	Neon Indicator Mechanism 250V Green
MENOR	Neon Indicator Mechanism 250V Orange
MENRD24	Neon Indicator Mechanism 24V Red
MENGR24	Neon Indicator Mechanism 24V Green
MENOR24	Neon Indicator Mechanism 24V Orange

Certification:
TBC

GSM Electrical (Australia) Pty Ltd
Level 2, 142-144 Fullarton Road, Rose Park SA 5067
P: 1300 301 838 F: 1300 301 778 E: service@g sme.com.au

www.gsme.com.au



Data Specification Sheet
June 2021

MERJ5CM
MERJ6CM
MERJ6CMBK
MERJ45PH8P4C

*See current catalogue for further detail

Note:
MERJ5CM was CORJ5CM
MERJ6CM was CORJ6CM

Cleaning Guide:

Spraying cleaning products on to electrical products is not recommended. It is important to ensure that switches are turned off before cleaning.

Do not use any cleaning sprays - only wipe down with damp cloth or rub with dry cloth. (Do not use an abrasive cloth as it may scratch the plastic).

Do not use harsh chemical cleaners as these can break down the plastic and cause it to crack.



Meerkat Range of Data Mechs

MERJ5CM - Cat5e Data Jack Clip in Mech

- Approved to AS/CA S008
- Clips into standard plate aperture
- Terminates with both the Krone# and 110 tools
- Colour: White



MERJ6CM - Cat6 Data Jack Clip in Mech (White)
MERJ6CMBK - Cat6 Data Jack Clip in Mech (Black)

- Approved to AS/CA S008
- Clips into standard plate aperture
- Terminates with both the Krone# and 110 tools



MERJ45PH8P4C

- Approved to AS/CA S008
- Clips into standard plate aperture
- Terminates with the Krone#
- Has phone symbol on front of jack
- Contains four (4) contact termination points
- Colour: White



#Krone is a registered trademark of Krone G.m.b.H

THIS TERMINATION INSTRUCTION IS FOR MERJ5CM AND MERJ6CM ONLY

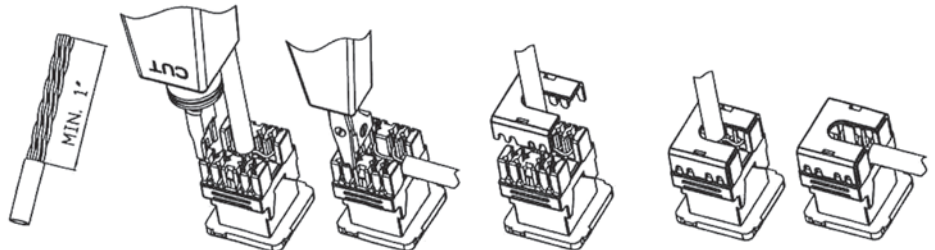

STEP 1:

Strip off at least 1 inch of jacket from end of cable.

STEP 2:

Insert wires into IDC's according to the desired wiring configuration (T568B/T568A). Terminate wires using punch down tool. Make sure the tool is set to trim excess wire as shown.

*Do not untwist the wire pairs until the punch down tool has trimmed them flush.

STEP 3:

Place termination cap on jack and press cap to make sure it is fully seated.

STEP 4:

Adjust the cable to a suitable position in the opening of the cap.

Catalogue Number	Description
MERJ5CM	Data Outlet Clip in Mech - Cat5e
MERJ6CM	Data Outlet Clip in Mech - Cat6 - White
MERJ6CMBK	Data Outlet Clip in Mech - Cat6 - Black
MERJ45PH8P4C	RJ45 Cat3 Phone Jack

Note: MERJ5CM was CORJ5CM / MERJ6CM was CORJ6CM

Certification:

Test Reports: Austest 0318GSM_CORJ5CM_S008
Test Reports: Austest 0321GSM_CORJ6CM_S008
Test Report : Australian Communications Laboratory
Pty Ltd ACL 1270 (for MERJ45PH8P4C)

GSM Electrical (Australia) Pty Ltd

Level 2, 142-144 Fullarton Road, Rose Park SA 5067
P: 1300 301 838 F: 1300 301 778 E: service@gsm.com.au

www.gsm.com.au



METVFPCM
METVFFCMFX
METVFFA90FX

*See current catalogue for further detail

Cleaning Guide:

Spraying cleaning products on to electrical products is not recommended. It is important to ensure that switches are turned off before cleaning.

Do not use any cleaning sprays - only wipe down with damp cloth or rub with dry cloth. (Do not use an abrasive cloth as it may scratch the plastic).

Do not use harsh chemical cleaners as these can break down the plastic and cause it to crack.



Meerkat Range of TV Mechs

METVFPCM

- TV Socket F Type to PAL Modular Clip
- Clip in mechanism is made from UV stabilised polycarbonate to avoid discolouring to yellow
- Colour: White



METVFFCMFX

- TV Socket, F to F Type Connection Modular Clip Foxtel Approved F30561
- Clip in mechanism is made from UV stabilised polycarbonate to avoid discolouring to yellow
- Colour: White



METVFFA90FX

- TV Socket, F to F Type Connection Adapter 90° Foxtel Approved F30573



Catalogue Number	Description
METVFPCM	TV Socket F Type to PAL Modular Clip
METVFFCMFX	TV Socket, F to F Type Connection Modular Clip Foxtel Approved
METVFFA90FX	TV Socket, F to F Type Connection Adapter 90° Foxtel Approved

MEHDMIFR
MEHDMI1
MEHDMI2

*See current catalogue for further detail



Meerkat HDMI® Accessories

The Trader HDMI connectors and cables are manufactured and tested in accordance with the HDMI 2.0 specification

- HDMI 2.0 is backwards compatible with earlier versions of the HDMI specification
- Bandwidth up to 18Gbps
- Resolutions up to 4K@50/60 (2160p), which is 4 times the clarity of 1080p/60 video resolution
- Up to 32 audio channels
- Up to 1536kHz audio sample frequency
- Simultaneous delivery of dual video streams to multiple users on the same screen
- Simultaneous delivery of multi-stream audio to multiple users (Up to 4)
- Support for the wide angle theatrical 21:9 video aspect ratio
- Dynamic synchronization of video and audio streams

MEHDMIFR

- HDMI® Flat Ribbon - Fem to Fem 12.5cm



MEHDMI1

- HDMI® Socket Cable - Fem to Fem 18cm
With 1 clip



MEHDMI2

- HDMI® Cable - Fem to Fem 2.5m
With 2 clips



Catalogue Number	Description
MEHDMIFR	HDMI® Flat Ribbon 12.5cm
MEHDMI1	HDMI® Socket Cable Connection Fem/Fem with 1 Clip, 18cm
MEHDMI2	HDMI® Socket Cable Connection Fem/Fem with 2 Clips, 2.5m

Fan Controller + Capacitor

MEFC

MEFC2

Fan Controller (less capacitor)

MEFCM

Capacitor Only

MEFCCAP

MEFC2CAP

Knob Styles available include:

MEFCKBMW

MEFCKBFW

MEFCKBBK

MEFCKBMBK

Cleaning Guide:

Spraying cleaning products on to electrical products is not recommended. It is important to ensure that switches are turned off before cleaning.

Do not use any cleaning sprays - only wipe down with damp cloth or rub with dry cloth. (Do not use an abrasive cloth as it may scratch the plastic).

Do not use harsh chemical cleaners as these can break down the plastic and cause it to crack.



Meerkat Fan Controllers

MEFC Fan Controller Capacitor: 1.6uF to 2.3uF 75VA capacitor 3 speed, 250V~ 3A M5

MEFC2 Fan Controller Capacitor: 1.8uF to 2.7uF 75VA capacitor, 3 speed, 250V~ 3A M5

The MEFC and MEFC2 fan controllers are set up for use with a wide range of existing ceiling fans. They clip into many Australian wall plates and look their best in the TRADER range. They also suit other plates in the market that use the common Clipsal* style aperture.

The design of the controllers suits standard layouts with the capacitor positioned below the mech and behind the wall plate. The two different capacitors provide speed control for the most common style of AC motors in the market.

Various knob finishes are available to suit replacement into different wall plate ranges.

Please note the fan controller knobs do not fit Clipsal* fan controller shafts, as there is a size difference.

Fan Controllers (less capacitor) and Capacitors are also available as spare parts, refer to table below.



MEFC
Supplied with standard white knob



MEFC2
Supplied with standard white knob



Example above shows Trader's Leopard Range (LESWPV1G) with MEFCKB standard white knob supplied

Alternative colours and knob finishes available:



MEFCKBMW
Matt White



MEFCKBFW
Feral White



MEFCKBBK
Black



MEFCKBMBK
Matt Black

Catalogue Number	Description
MEFC	Fan Controller, 1.6uF to 2.3uF 75VA capacitor, 3 speed, 250V~ 3A M5
MEFC2	Fan Controller, 1.8uF to 2.7uF 75VA capacitor, 3 speed, 250V~ 3A M5
MEFCM	Fan Controller Mechanism (less capacitor) 3 speed, 250V~ 3A M5
MEFCCAP	Capacitor 1.6uF to 2.3uF 75VA for MEFC Fan Controller 280V AC
MEFC2CAP	Capacitor 1.8uF to 2.7uF 75VA for MEFC2 Fan Controller 280V AC

*The Clipsal brand and associated products are registered trademarks of Schneider Electric (Australia) Pty Ltd. GSM Electrical (Australia) Pty Ltd, the TRADER brand and it's products, have no endorsement or affiliation with Schneider Electric Pty Ltd.

Certification Number: GMA-506952-EA

GSM Electrical (Australia) Pty Ltd

Level 2, 142-144 Fullarton Road, Rose Park SA 5067

P: 1300 301 838 F: 1300 301 778 E: service@gsme.com.au

www.gsme.com.au



Data Specification Sheet
March 2021

**MEPBM
MEPBMBK
MEPBMMW
MEPBMMBK**



Cleaning Guide:

Spraying cleaning products directly on to electrical switches or power points (sockets) is not recommended.

It is important to ensure that switches are turned off before cleaning.

Do not use any cleaning sprays - only wipe down with damp cloth or rub with dry cloth. Do not use an abrasive cloth as it may scratch the plastic.

Do not use harsh chemical cleaners as these can break down the plastic and cause it to crack.



Meerkat Momentary Push Button

- 2 Amp 240V~
- This is a momentary push action switch. It makes contact when pushed in, and breaks contact when released. It does not have a snap action feel.
- Available with different print markings which can be ordered through the customer service team.
- Ideal for use in building / lighting control systems as an interface button.
- Suitable for use in all Trader switch plate ranges and most Clipsal* ranges too.
- Buttons can be labelled for identification. Contact TRADER for printing service.

Catalogue Number	Description
MEPBM	Push Button Switch, Momentary, 2A 250V~ White
MEPBMBK	Push Button Switch, Momentary, 2A 250V~ Black
MEPBMMW	Push Button Switch, Momentary, 2A 250V~ Matt White
MEPBMMBK	Push Button Switch, Momentary, 2A 250V~ Matt Black

*The Clipsal brand and associated products are Trademarks of Schneider Electric (Australia) Pty Ltd. and used for reference only

Certification Number: SAA-1730190-EA

GSM Electrical (Australia) Pty Ltd
Level 2, 142-144 Fullarton Road, Rose Park SA 5067
P: 1300 301 838 F: 1300 301 778 E: service@gsm.com.au
www.gsm.com.au



Data Specification Sheet
March 2022

MEPBE



MEERKAT
MEPBE

USED IN CONJUNCTION WITH:
MEPBMW Push Button
Multi-Way Remote
Dimming and On/Off
Switching



BUTTON CAPS:

MEBUMW
MEBUMBK
MEBUC
MEBUCBK
MEBUCMW
MEBUCMBK

Cleaning Guide:

Spraying cleaning products directly on to electrical switches or power points (sockets) is not recommended.

It is important to ensure that switches are turned off before cleaning.

Do not use any cleaning sprays - only wipe down with damp cloth or rub with dry cloth. Do not use an abrasive cloth as it may scratch the plastic.

Do not use harsh chemical cleaners as these can break down the plastic and cause it to crack.



Push Button Switching

MEPBE Push Button, Electronic On/Off Switch, 3-wire

FEATURES

- Soft touch push button ON/ OFF switch.
- Blue LED indicates device status.
- Returns to OFF after loss of power.
- Compatible with a wide range of load types including wire wound transformers & fan motors.
- Compatible with Trader and Clipsal* Style wall plates.
- Multi-Way Switching when used in conjunction with the MEPBMW Multi-Way Remote Dimmer & ON/OFF Push Button.
- Supplied with MEBU Gloss White & Gloss Black buttons, suits Puma, Cougar & Flat Cat gloss finishes.

OPERATING CONDITIONS

- Operating Voltage: 230 – 240V a.c. 50Hz
- Maximum Load: 1200W / 500VA (see table below)
- Maximum Current Capacity: 5A
- Terminals: Screw Terminals suit 0.5mm² to 1.5mm² stranded cable (bootlace terminal recommended)
- Operating Temperature: 0 to +50 °C
- Compliance Standard: CISPR15, AS/NZS 3100, AS/NZS 60669.2.1

Note: Operation at temperature, voltage or load outside of the specifications may cause permanent damage to the unit.

LOAD COMPATIBILITY

LOAD TYPE	COMPATIBILITY
Incandescent / 240V Halogen	1200W
Fluorescent Tube with Electronic Ballast	500VA
Fluorescent Tube with Iron Core Ballast	500VA
Compact Fluorescent	500VA
Electronic Transformer	500VA
LED	500VA
Wirewound Transformer	500VA
Fan Motors	500VA
Heating Elements	1200W

WHITE, BLACK, MATT WHITE & MATT BLACK BUTTONS AVAILABLE:

MEBUMW & MEBUMBK (curved button for Flat Cat),
MEBUC & MEBUCBK (flat button for Leopard and Snow Leopard),
MEBUCMW & MEBUCMBK (flat button for Clouded Leopard)



WIRING INSTRUCTIONS

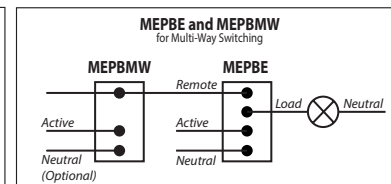
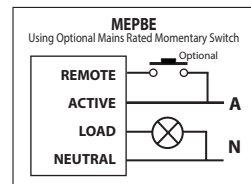

Catalogue Number	Description
MEPBE	Push Button, Electronic On/Off Switch, 3-wire
MEBUMW	Curved Button for MEPBE, MEPBMW & DIMPBD, for use with Flat Cat Matt White
MEBUMBK	Curved Button for MEPBE, MEPBMW & DIMPBD for use with Flat Cat Matt Black
MEBUC	Flat Button Gloss White for DIMPBD, MEPBE, MEPBMW for use & best aperture fit with Leopard & Snow Leopard White.
MEBUCBK	Flat Button Gloss Black for DIMPBD, MEPBE, MEPBMW use & best aperture fit with Leopard & Snow Leopard Black.
MEBUCMW	Flat button for MEPBE, MEPBMW & DIMPBD for use & best aperture fit with Clouded Leopard Matt White. Not suitable for Flat Cat.
MEBUCMBK	Flat button for MEPBE, MEPBMW & DIMPBD for use & best aperture fit with Clouded Leopard Matt Black. Not suitable for Flat Cat.

*The Clipsal brand and associated products are Trademarks of Schneider Electric (Australia) Pty Ltd. and used for reference only.

Certification Number: GMA-504067-EA

GSM Electrical (Australia) Pty Ltd

Level 2, 142-144 Fullarton Road, Rose Park SA 5067

P: 1300 301 838 F: 1300 301 778 E: service@gsme.com.au

www.gsme.com.au



MEPBMW



MEERKAT
MEPBMW

CAN BE USED IN CONJUNCTION WITH:
MEPBE Electronic Switch



DIMPBD Digital Switched Dimmer



BUTTON CAPS:

MEBUMW
MEBUMBK
MEBUC
MEBUCBK
MEBUCMW
MEBUCMBK

Cleaning Guide:

Spraying cleaning products directly on to electrical switches or power points (sockets) is not recommended.

It is important to ensure that switches are turned off before cleaning.

Do not use any cleaning sprays - only wipe down with damp cloth or rub with dry cloth. Do not use an abrasive cloth as it may scratch the plastic.

Do not use harsh chemical cleaners as these can break down the plastic and cause it to crack.



Push Button Switching & Dimming

MEPBMW Push Button, Multi-Way Remote Dimming and On/Off Switching

The MEPBMW Remote Button enables Multi-Way dimming and ON/OFF switching with the DIMPBD Digital Dimmer. It can also be used in conjunction with MEPBE switch for Multi-Way ON/OFF control switching only. An inbuilt LED indicator can be configured two ways by connecting Neutral to the MEPBMW:

1. The LED indicator can be permanently "ON".
2. Or "ON" while the button is pressed.

The MEPBMW will operate without neutral connected but the LED indicator will not function.

Multiple MEPBMW push button mechanisms can be connected in parallel to a single DIMPBD dimmer or a MEPBE electronic switch, provided the total length of the remote connection does not exceed 50 metres.

It operates as a 'slave' button and provides full functionality to the master module that it is connected to.

LOAD COMPATIBILITY

- For use with MEPBE or DIMPBD mechs only (NOT FOR STANDALONE MAINS SWITCHING).

FEATURES

- Enables Multi-Way dimming and ON/OFF switching for DIMPBD Digital Dimmers.
- Enables Multi-Way ON/OFF switching for MEPBE Electronic Switches.
- Neutral not required for button only operation (no illumination).
- Optional LED Indicator operation requires Neutral.
- Suits Trader and Clipsal* style wall plates.
- Supplied with MEBU Gloss White & Gloss Black buttons, suits Puma, Cougar & Flat Cat gloss finishes.

OPERATING CONDITIONS

- Operating Voltage: 230 - 240Va.c. 50Hz.
- Power Rating: Based upon connected Dimmer or Electronic Switch.
- Connection Type: Flying leads with bootlace terminals.
- Operating Temperature: 0 to +50 °C.
- Compliance Standard: AS/NZS 60669.2.1, CISPR15.

Note: Operation at temperature, voltage or load outside of the specifications may cause permanent damage to the unit.

WHITE, BLACK, MATT WHITE & MATT BLACK BUTTONS AVAILABLE:

MEBUMW & MEBUMBK (curved button for Flat Cat),

MEBUC & MEBUCBK (flat button for Leopard and Snow Leopard),

MEBUCMW & MEBUCMBK (flat button for Clouded Leopard)



WIRING INSTRUCTIONS

WIRING FOR LED AND BUTTON OPERATION - NEUTRAL PRESENT

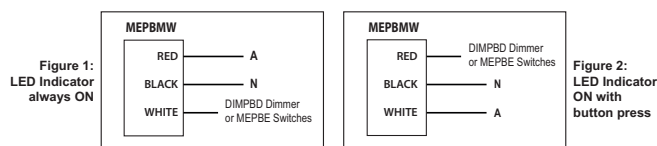

WIRING FOR BUTTON ONLY OPERATION - NO NEUTRAL REQUIRED

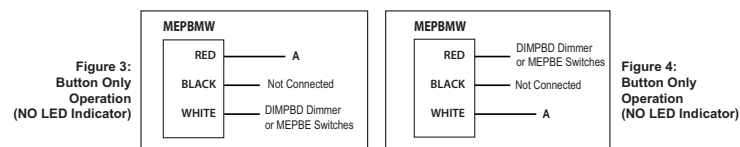

WIRING MULTIPLE REMOTE BUTTONS WITH DIMPBD DIMMERS

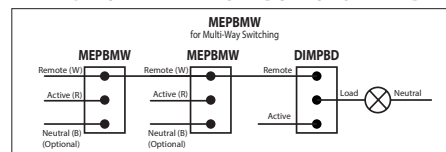

- Multiple Remote Buttons can be used, provided the total remote wiring length does not exceed 50 metres.
- Either LED ON or Button only wiring configurations can be used.

*The Clipsal brand and associated products are Trademarks of Schneider Electric (Australia) Pty Ltd. and used for reference only.

Certification Number: GMA-503779-EA

GSM Electrical (Australia) Pty Ltd

Level 2, 142-144 Fullarton Road, Rose Park SA 5067

P: 1300 301 838 F: 1300 301 778 E: service@gsme.com.au

www.gsme.com.au



METVBFM3790

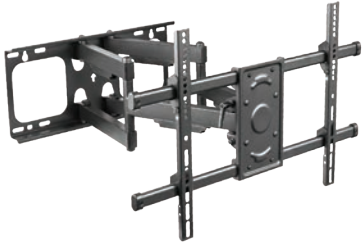

Cleaning Guide:

Spraying cleaning products directly on to electrical switches or power points (sockets) is not recommended.

It is important to ensure that switches are turned off before cleaning.

Do not use any cleaning sprays - only wipe down with damp cloth or rub with dry cloth. Do not use an abrasive cloth as it may scratch the plastic.

Do not use harsh chemical cleaners as these can break down the plastic and cause it to crack.



Meerkat TV Bracket, Full Motion to suit most 37-90 inch TVs

The METVBFM3790 offers heavy duty support for large TVs as well as the ability to swivel, allowing you to achieve any number of desired viewing angles. The unit suits most TVs measuring between 37 inches and 90 inches. It boasts a 65kg load rating and is VESA compatible.

Features and Benefits

- Suitable for most large TV's 37 - 90 inch
- Heavy duty 65kg load rating
- VESA Compatible: 200x200, 300x300, 400x200, 400x400, 600x400
- Built in level adjustment + or -3 degree
- Includes cable management
- Suitable for mounting on Solid Walls or Double Studs (406mm/450mm)

Specifications:

- Suits 37 – 90" Screen Size
- Max Weight Capacity 65kg
- Max VESA Size 600 x 400
- Profile 69 - 635mm
- Tilt Range +5° to -15°
- Swivel Range +60° to -60°
- Screen Level +3° to -3°
- Double Stud 406mm/450mm
- Product Weight 10.26kg

EXTRAS INCLUDED



Puma Double Power Point
PUPP2G



Puma Entertainment plate
PUENTP3G

Note:

Please check the weight and mounting hole distance of your TV before selecting a suitable mounting bracket.

Catalogue Number	Description
METVBFM3790	Television Bracket Full Motion Suitable for 37 to 90 inch flat or curved TV's Max weight 65kg

Certification Number: TBC

GSM Electrical (Australia) Pty Ltd

Level 2, 142-144 Fullarton Road, Rose Park SA 5067

P: 1300 301 838 F: 1300 301 778 E: service@g sme.com.au

www.g sme.com.au



MENLML

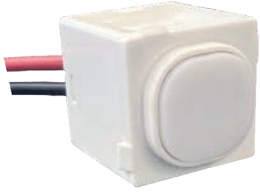

Cleaning Guide:

Spraying cleaning products directly on to electrical switches or power points (sockets) is not recommended.

It is important to ensure that switches are turned off before cleaning.

Do not use any cleaning sprays - only wipe down with damp cloth or rub with dry cloth. Do not use an abrasive cloth as it may scratch the plastic.

Do not use harsh chemical cleaners as these can break down the plastic and cause it to crack.



Meerkat Nightlight Push Button Mech, Multi Level Control, 230-250V~

Push-Button Multi-level nightlight for access areas, passageways, corridors, utility rooms.

Provides sufficient light to see outlines of objects.

Made compact for a reason:

- Fits all Trader apertures, switches and power points with removable extra switch mechanisms: Snow Leopard, Clouded leopard, Leopard, Puma, Flat Cat and Cougar ranges.
- Three levels of brightness, push-button activated:

Level 1: (Press once)

Brightness: 160 lux max (no lumens. Lumens cannot be measured due to light output too low)

Light temperature: 1800-2000 K warm white

Power: 250V 0.4W 0.00016A

Level 2: (Press twice)

Brightness: 440 lux max

Light temperature: 1800-2000 K warm white

Power: 250V 0.4W 0.0016A

Level 3: (Press three times)

Brightness: 800 lux max

Light temperature: 1800-2000 K warm white

Power: 230-250V 0.4W 0.0016A

- Original State, OFF: (Press four times)
- Standby Power in Original State, OFF: 250V 0.3W 0.0012A

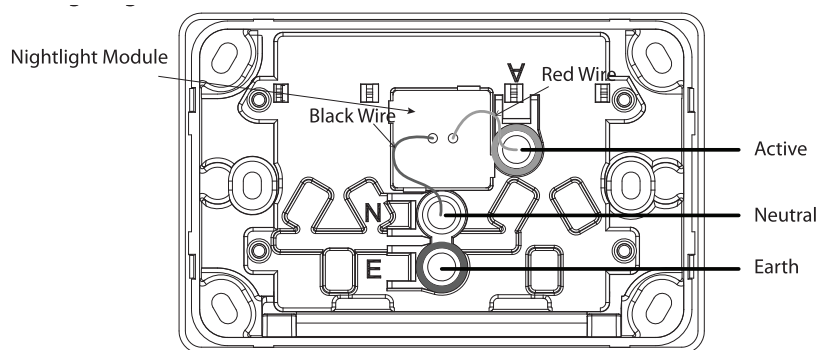

Catalogue Number	Description
MENLML	Nightlight Push Button Mech, Multi Level Control, 230-250V~

Certification Number: GMA-511872

GSM Electrical (Australia) Pty Ltd

Level 2, 142-144 Fullarton Road, Rose Park SA 5067

P: 1300 301 838 F: 1300 301 778 E: service@gsm.com.au

www.gsm.com.au



**MESPBT
MESPP**

Page 1 of 2



Cleaning Guide:

Spraying cleaning products directly on to electrical switches or power points (sockets) is not recommended.

It is important to ensure that switches are turned off before cleaning.

Do not use any cleaning sprays - only wipe down with damp cloth or rub with dry cloth. Do not use an abrasive cloth as it may scratch the plastic.

Do not use harsh chemical cleaners as these can break down the plastic and cause it to crack.



Meerkat Speaker Set, Bluetooth, 2 Speakers, 1 x Active / 1 x Passive, 6.5 inch 8 Ohm 30 Watts each

Innovative Bluetooth Ceiling Speaker System (MESPBT), allows music and audio streaming wirelessly via phone or tablet devices. Additional passive speakers (MESPP) available separately to expand the system. (Maximum of 4 speakers)

- Easy installation and fast Bluetooth connection (V4.2)
- Amplifier contained within the active speaker.
- Three additional terminals on the active speaker allow expansion to a max 4-speaker system (1 x active speaker plus 3 x passive speakers)
- Speaker grilles can be painted (remove from speaker)
- Can be installed in a fire-rated ceiling, fire-hood required
- Can be hard-wired to CD player and Blu-Ray player devices via RCA cable
- Not suitable for bathroom or wet areas
- 200mm mounting hole
- 30mm thick panel max.

MESPP Box Content:

- 1 Master 2-way active speaker with amplifier
- 1 15V dc 220-240V ac power supply
- 1 x 2-way Passive speaker
- 10 metre speaker cable
- 2 speaker grilles
- A cardboard cutting template is included in the box.

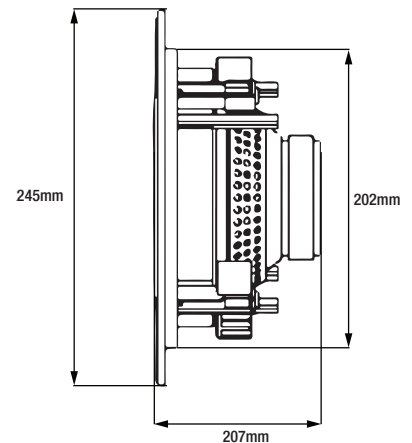

MESPP



MESPBT



Catalogue Number	Description
MESPBT	Speaker Bluetooth 6.5 inch 30 Watt, 2 Speakers
MESPP	Speaker Passive 6.5 inch 30 Watts

Certification Number: TBC

GSM Electrical (Australia) Pty Ltd

Level 2, 142-144 Fullarton Road, Rose Park SA 5067

P: 1300 301 838 F: 1300 301 778 E: service@gsm.com.au

www.gsm.com.au



**MESPBT
MESPP**

Page 2 of 2



Cleaning Guide:

Spraying cleaning products directly on to electrical switches or power points (sockets) is not recommended.

It is important to ensure that switches are turned off before cleaning.

Do not use any cleaning sprays - only wipe down with damp cloth or rub with dry cloth. Do not use an abrasive cloth as it may scratch the plastic.

Do not use harsh chemical cleaners as these can break down the plastic and cause it to crack.



Meerkat Speaker Set, Bluetooth, 2 Speakers, 1 x Active / 1 x Passive, 6.5 inch 8 Ohm 30 Watts each

Active speaker:

- Power RMS: 30 Watts per speaker
- Power Max approx.: Max peak power 50W
- Impedance: 8 Ohm
- Frequency response: 100Hz-20kHz
- SPL@1W/1m:86dB (Sensitivity: 86dB 1W/1m)
- Woofer Diameter: 165mm (6.5")
- Tweeter: 25.4mm (1") Silk Dome
- Overall Diameter: 245mm
- Depth: 112.5mm
- Mounting hole diameter: 202mm
- Mounting depth from flange: 105mm
- Weight: Approx: 3kg
- Amplifier: Class D
- Stereo Amplifier: Yes
- Output Speaker channels total:
(1 active + 3 passive)
- Plug power pack input: 220-240V ac 50/60Hz
- Amplifier input from power pack: 15V dc 2A
- Bluetooth System: V4.2 EDR
- Bluetooth range: Up to 10 metres
- Uniquely addressable: Yes
- Auxiliary connection: Yes
- Standby power: Max 1.65W
- Speaker cable length supplied: 10 metres
- IP Rating: N/A
- Speaker cone colour: Black
- Speaker cover colour: White

Passive speaker:

- Power RMS: 30 Watt per speaker
- Power Max approx.: Max peak power 50W
- Impedance: 8 Ohm
- Frequency response: 100Hz-20kHz
- SPL@1W/1m: 86dB
- Woofer Diameter: 165mm (6.5")
- Tweeter: 25.4mm (1") Silk Dome
- Overall Diameter: 245mm
- Depth: 112.5mm
- Mounting hole diameter: 202mm
- Mounting depth from flange: 105mm
- Weight: Approx: 3kg
- Auxiliary connection: No
- Speaker cable length supplied: 10 metres
- IP Rating: N/A
- Speaker cone colour: Black
- Speaker cover colour: White

Catalogue Number	Description
MESPBT	Speaker Bluetooth 6.5 inch 30 Watt, 2 Speakers
MESPP	Speaker Passive 6.5 inch 30 Watts

Certification Number: TBC

GSM Electrical (Australia) Pty Ltd

Level 2, 142-144 Fullarton Road, Rose Park SA 5067

P: 1300 301 838 F: 1300 301 778 E: service@gsm.com.au

www.gsm.com.au

