

**FIRE TEK Smoke alarm**  
755RLPSMA4  
240 V a.c. Mains Power Photoelectric Smoke Alarm with Rechargeable Battery Backup

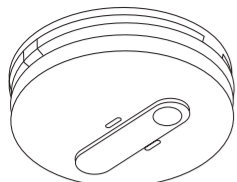

**More information is available**



[https://download.schneider-electric.com/files?p\\_Doc\\_Ref=EAV8159103](https://download.schneider-electric.com/files?p_Doc_Ref=EAV8159103)

Scan the QR code for more information about your Clipsal smoke alarm:

- What smoke alarms can and cannot do
- Developing and practising a plan of escape
- What to do if an alarm sounds.

**Operating elements**

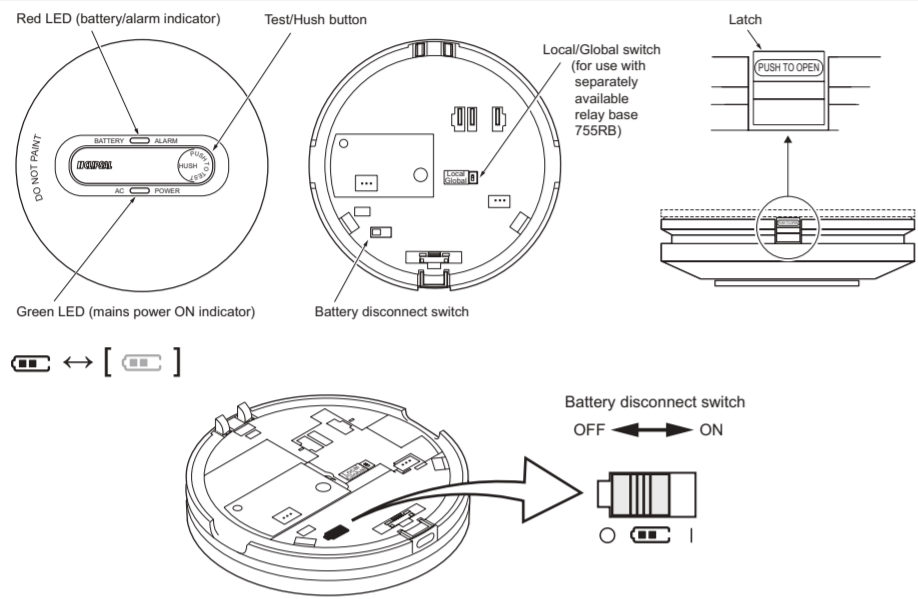

**Installation location**

Install more than 1 m away from air conditioner/heater vents and fans, electrical sources, appliances and fittings.

Do not install in garages, kitchens, bathrooms or any area with high levels of moisture, dirt or insects.

For garages: A heat alarm is more suitable as it is not affected by particulates.

Dead air space (do not install in these locations)

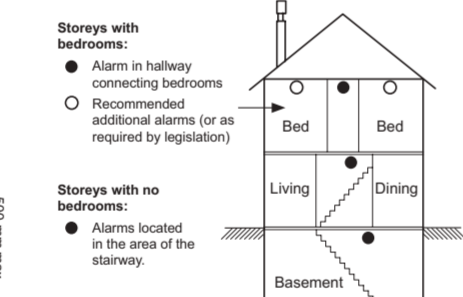
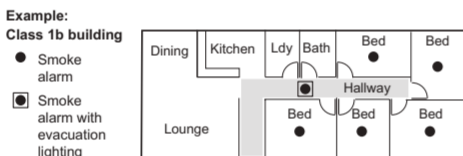
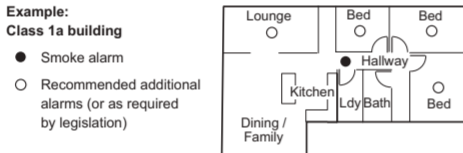
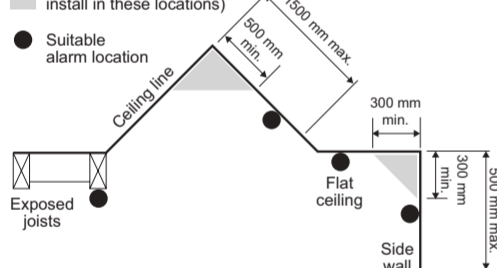

**Installation**

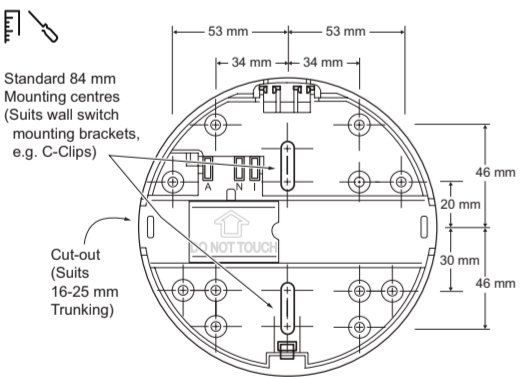

Note: Ensure that the alarm base is mounted flat against the mounting surface.

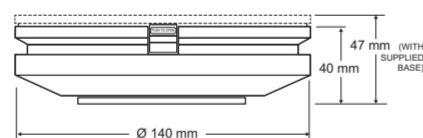

**Single alarm**

Terminal markings:

- A: Active/Line (Red)
- E-Loop: Earth Wire
- N: Neutral (Black)
- I-Connect: Interconnect



**Interconnected alarms**

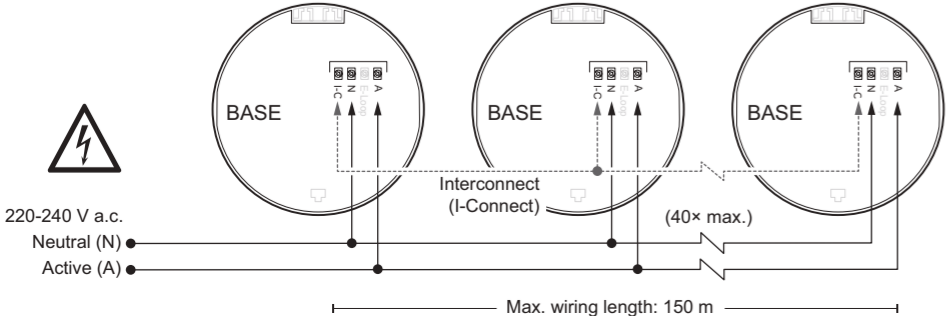

**Operating the smoke alarm**

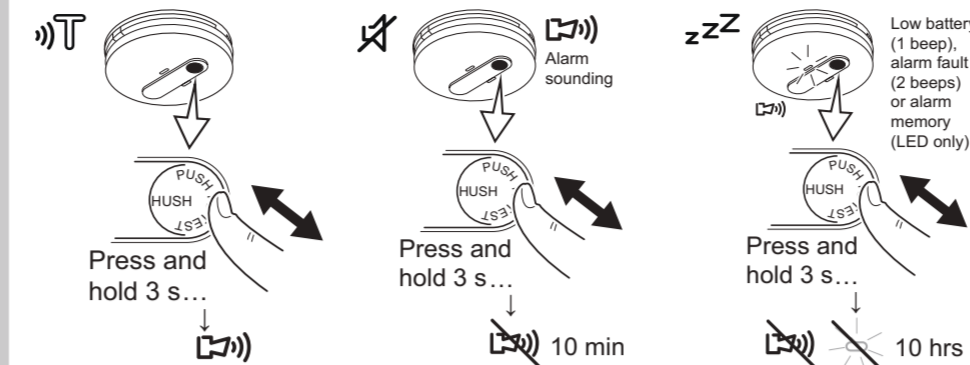

**General information**

- Leave these instructions with the occupant, to be retained for the life of the alarm.
- This smoke alarm must be installed by a licenced electrician.
- Do not remove dust cover until 24 hours after all construction has been completed. Construction dust and chemicals can cause contamination and false alarms.
- Important: Dust cover must be removed before smoke alarm will operate correctly.

**For your safety**

**⚠ DANGER**

**EQUIPMENT INSTALLATION HAZARD**

RISK OF ELECTRIC SHOCK, EXPLOSION OR ARC FLASH

- This product must only be installed and serviced by appropriately qualified and/or licenced electrical personnel.
- This product must only be used for the purpose described in these instructions and must be installed in accordance with the wiring rules and regulations in that location.
- Isolate the electrical supply before doing any work on this product.
- Ensure the product has been correctly installed and tested for safe operation before reconnecting the electrical supply.

Failure to follow these instructions will result in death or serious injury.

**⚠ CAUTION**

**EQUIPMENT INSTALLATION HAZARD**

- Ensure active and neutral from mains power are wired to the correct terminals.
- Ensure the green LED is ON when mains power is supplied.
- Ensure the red LED is not flashing quickly.
- Test each interconnected unit 1 by 1. Press and hold the Test button until second burst of 3 beeps has finished. If any unit fails to alarm, check all wiring and connections.

Failure to follow these instructions may result in injury or equipment damage.

**Operating elements**

**Activating the battery for use or disconnecting for transport/storage**

- Ensure that the battery disconnect switch is set to the battery ON position after installation. The rechargeable batteries are not connected, nor can the unit be closed onto the base, until the switch has been moved to the Battery ON position.

**Choosing the installation location**

- Prior to installing, ensure there are no obstructions in ceiling mounting locations, such as pipes or cables.

**NOTICE**

**EQUIPMENT INSTALLATION COMPLIANCE**

This smoke alarm must be installed in accordance with the National Construction Code and any local state legislation requirements.

Failure to follow these instructions may result in a non-compliant installation.

**Installing the smoke alarm**

- Only install smoke alarm indoors in a stand-alone or interconnected set up (see *Interconnecting smoke alarms*).
- Use minimum cable width 1 mm² for all wiring, including interconnect wiring where used.
- Do not remove the dust cover until you are ready to test the unit. See ⇒

**Mounting the smoke alarm**

**Connecting the smoke alarm**

**Interconnecting smoke alarms**

**⚠ CAUTION**

**EQUIPMENT INSTALLATION HAZARD**

- All interconnected smoke alarms must be supplied from the same circuit.
- A common Neutral must be used for the Interconnect to operate.
- DO NOT connect the Interconnect wire to Active or Neutral.
- Maximum of 40 interconnected smoke alarms.
- Only Clipsal smoke alarms are compatible for interconnection with this alarm.

Failure to follow these instructions may result in injury or equipment damage.

- Maximum wire length between first and last alarm is 150 m.

**Wireless interconnection**

An optional wireless base (Catalogue No. 755RFB2) may be purchased separately if wired interconnection is not possible.

- A maximum of 40 smoke alarms can be interconnected using wireless bases.

**Operating the smoke alarm**

**Testing the smoke alarm**

**⚠ CAUTION**

**DO NOT USE OPEN FLAME**

Never use an open flame of any type to test your alarm.

Failure to follow this instruction may result in injury or equipment damage.

- Test the smoke alarm once per month to ensure proper operation.
- If no alarm sounds, check that the battery disconnect switch is in the ON position. (See ⇒ → ) If the battery disconnect switch is in the ON position and the alarm still doesn't sound, replace the smoke alarm.
- If the smoke alarm is installed in a mobile home, test weekly and before every journey.
- IMPORTANT: If premises are unoccupied for a more than a few days, a battery test must be undertaken upon return. If the low battery warning sounds, connect mains power (220-240 V a.c.) to the premises or mobile home and allow the built-in battery to recharge.
- Check that all interconnected smoke alarms operate during the test.

**Interconnected smoke alarms**

- Test each alarm in an interconnected group.
- For each alarm test, ensure that all interconnected alarms operate.

**Silencing the smoke alarm (Hush feature)**

- When the Test/Hush button is pressed during an alarm event, the smoke alarm is not sensitive to smoke for 10 minutes, after which the alarm resumes normal operation.
- During this hush time, the red LED flashes once every 8 seconds.
- Wait 10 minutes before performing any additional testing to avoid any abnormal alarm responses.

**Snoozing low battery, fault and alarm memory indications**

- When the backup battery gets low, the red LED flashes once every 40 seconds, together with a beep sound. You can snooze the low battery indication for 10 hours by pressing the Test/Hush button for 3 seconds.

**Alarm fault**

- When an alarm fault is detected, the red LED flashes once every 40 seconds, together with 2 beeps. You can snooze the alarm fault indication for 10 hours by pressing the Test/Hush button for 3 seconds.

**Alarm memory**

- In an interconnected alarm group, the red LED on the triggered alarm flashes once every 2 seconds for 72 hours after the alarm beeping has stopped, so that you can identify the unit as the alarm that was triggered. Press the Test/Hush button for 3 seconds to snooze the flashing LED for 10 hours. The snooze function for the alarm memory can be repeated as often as desired up to the 72 hour limit.

**LED and sound indications**

Operating mode	Red LED	Sound	Duration
<b>Normal mode / Standby mode</b>	1 flash every 40 s	OFF	—
<b>ALARM MODE</b>			
Local alarm	1 flash every 1 s	Continuous siren	—
Interconnected alarm	OFF	Continuous siren	—
<b>Test mode</b>	1 flash every 1 s	Siren (3 s)	—
<b>Hush mode</b>	1 flash every 8 s	OFF	10 min
<b>ALARM MEMORY (triggered alarm only)</b>			
Normal	1 flash every 2 s after alarm stops	OFF	Total 72 hrs
Hushed during alarm	1 flash every 2 s after Hush started	OFF	Total 72 hrs
Snooze	See Snooze Mode		
<b>Low battery mode</b>	1 flash every 40 s	1 beep every 40 s	Until battery voltage reaches 7.5 V or above
<b>Fault mode</b>	2 flashes every 40 s	2 beeps every 40 s	Until fault has been cleared
<b>SNOOZE MODE</b>			
Low battery	1 flash every 24 s	OFF	10 hrs
Fault	1 flash every 24 s	OFF	10 hrs
Alarm memory	1 flash every 40 s	OFF	10 hrs
<b>Green LED</b>			
Mains power ON	ON	—	—

**Troubleshooting**

Problem	Cause and Resolution
<b>ALARM SOUNDS AND SILENCING</b>	
Alarm sounds and the red LED is blinking rapidly	Smoke has activated the smoke alarm. Vacate the building immediately and call the Fire and Emergency Services. See <i>False Alarm</i> section.
Alarm sounds but the red LED is OFF	Smoke has activated an interconnected alarm, located somewhere else in the building. Vacate the building immediately and call the Fire and Emergency Services. See <i>False alarm</i> section.
Smoke alarm is sounding, it stops when Test/Hush is pressed	Hush or silence feature has been activated for 10 minutes providing the smoke density does not increase. Ensure you are safe and have put out the source of the smoke. See <i>False alarm</i> section.
Red LED is flashing every 2 seconds	Alarm memory has been activated, indicating that this alarm was the triggered alarm in the group. LED stops flashing after 72 hours. Press Test/Hush to snooze the LED indication for 10 hours.
Smoke alarm is sounding and does not stop when Test/Hush is pressed	Smoke density is too high for the Hush or Silence feature to activate. Vacate the building immediately and call the Fire and Emergency Services. See <i>False alarm</i> section.
When Test/Hush button is pressed for three seconds alarm sounds briefly	The smoke alarm horn is indicating that all electronic circuitry, horn and battery are working. Normal test condition. Test regularly to ensure proper operation.
When Test/Hush button is pressed for three seconds alarm does not sound	The smoke alarm may not be operating correctly. Check and ensure that the green LED is ON and the red LED flashes once every 40 seconds. If the problem persists contact an electrician for replacement.
<b>BEEPING</b>	
One audible beep every 40 seconds	Low battery warning. Test and check the mains power connection. Ensure the battery disconnect switch is in the ON position.
Two audible beeps every 40 seconds	The smoke alarm may not be operating correctly. Clean smoke alarm according to the <i>Maintenance, Repairs and Service</i> section. If problem persists, contact an electrician for replacement.
<b>POWER</b>	
Green LED off	Mains power may be disconnected. Check mains power ON. Main circuit breaker may have tripped. Wiring could be wrong.
Red LED flashes very quickly (3 times per second)	Neutral connection is bad or wiring is wrong. Check wiring and connection of smoke alarms with flashing red LED and rectify wiring issue immediately.

**False Alarm**

In the event of a false alarm in an interconnected group, it is important to identify the triggering alarm(s). These alarms may need to be cleaned, serviced or replaced if necessary.

When alarms are sounding without any smoke present:

- Identify which smoke alarm(s) are being triggered – Look for the alarm(s) with sound and red LED flashing.
- Unclip all identified smoke alarms. Any remaining interconnected alarms will stop alarming in 1 minute.

- If the alarming stops before you have identified the alarms that are being triggered, look for any alarms with the red LED flashing once every 2 seconds. This flashing can be snoozed for 10 hours by pressing the Test/Hush button for 3 seconds. The snooze function can be repeated as often as desired up to the 72 hour limit.

- Clean affected smoke alarms in accordance with the *Maintenance, Repairs and Service* section.

- Re-install and test all the smoke alarms.

If all of the above fails, contact a licenced electrician for replacement.

**Maintenance, Repairs and Service**

**Maintenance**

It is recommended that the smoke alarm is inspected monthly to ensure it is free from dirt, dust and insects. The alarm can be vacuumed or brushed with a soft brush to remove dust, dirt or kitchen grease that has accumulated. Apply a small amount of insect surface spray to a cloth and wipe around alarm/s every 3-6 months to mitigate insect ingress.

**ALWAYS TEST THE SMOKE ALARM AFTER CLEANING**

**Repairs and Service**

**NOTICE**

**EQUIPMENT MAINTENANCE INSTRUCTIONS**

- Test this smoke alarm regularly to ensure the unit is functional and that the battery is in good condition.
- Replace the smoke alarm 10 years after date of manufacture.
- Do not open the smoke alarm casing or repair the smoke alarm yourself. There are no user-serviceable parts inside.

Failure to follow these instructions may result in equipment malfunction or failure.

**Disposal**

As the smoke alarm does not contain any radioactive material, disposal with normal rubbish is permitted in Australia and New Zealand.

Before disposal, move the battery disconnect switch to the disconnect position. This will prevent the low battery warning beep when the battery eventually discharges.

**Technical data**

Main Power Source	220–240 V a.c., 50 Hz
Secondary Power Source	Rechargeable lithium battery
Operating Current	≤40 mA
Battery Life	10 years
Sensing Type	Photoelectric. This alarm contains NO radioactive material.
Operating Temperature	0 °C to 45 °C
Ambient Humidity	5% to 95%
Interconnecting	Wired: 40 alarms over 150 metres maximum Wireless: 40 alarms maximum
Terminal Provisions	Active, Neutral, Loop and Interconnect terminals, each accommodates 2 × 1.5 mm²
Horn Level	85 dB at three metres minimum
Approvals	Activfire SAI Global RCM
Complies with	AS 3786: 2014, AS/NZS 60065 and AS/NZS 60950.1

It is recommended to dispose of this device at an authorised electronic waste collection point. Professional recycling protects people and the environment against potential negative effects.

**Trademarks and certifications**

Schneider Electric acknowledges that the Australian Standard Certified Product logo is a trademark of SAI Global, and that the Activfire Certified logo is a trademark of CSIRO.



**Warranty**

We warrant this product to be free from defects in materials and workmanship for a period of 5 (five) years from the date of installation.

**Customer care**

If you have technical questions, please contact the Customer Care Centre in your country.

**Australia**

**Schneider Electric (Australia) Pty Ltd**  
Customer Care Australia: 13 73 28  
e: [customercare.au@schneider-electric.com](mailto:customercare.au@schneider-electric.com)  
[www.schneider-electric.com.au](http://www.schneider-electric.com.au)

**New Zealand**

**Schneider Electric (NZ) Ltd**  
After hours service: 0800 735 4357 (NZ only)  
Customer Care NZ: 0800 652 999  
e: [sales@nz.schneider-electric.com](mailto:sales@nz.schneider-electric.com)  
[www.schneider-electric.com](http://www.schneider-electric.com)