

## 5.0 Assembly

1. Strip insulated wires from cores as shown.
2. Slip cable nut, thrust washer, cable seal, gland nut & body where relevant over the flexible cable.
3. Connect the Earth (Green/Yellow or Green) wire to terminal E  with green indication.
4. Connect the Active (Brown or Red) wire to the terminal marked 'A' for single phase or for 3 phase connect phase wires to 'L1' or 'L2' or 'L3' as appropriate.
5. Connect the Neutral (Blue or Black) wire to the terminal marked 'N'.
6. Flip up or clamp down the cord clamp around the outer sheath of the cable and tighten screw (Note: there must be at least 10mm of sheath beyond the end of the cord clamp).
7. Double check the wires are fitted to the correct terminals as illustrated and the terminal screws are tight.
8. Place the housing assembly into the sleeve and lock ring, slide the plug body into place and firmly screw parts together.
9. Slip the cable seal, thrust washer and cable nut where relevant down the cable and then tighten the gland nut &/or cable nut to ensure a proper seal of the cable into the body.

## 6.0 Cleaning and Maintenance

Some chemicals are not recommended for use with this product. For more details on which substances can be used in relation to this product please refer to [Schneider-Electric.com](http://Schneider-Electric.com)

## 7.0 Warranty Statement

1. The benefits conferred herein are in addition to, and in no way shall be deemed to derogate; either expressly or by implication, any or all other rights and remedies in respect to the Schneider Electric product, which the consumer has under the Commonwealth Trade Practices Act or any other similar State or Territory Laws.
2. The warrantor is Schneider Electric.
3. This Schneider Electric product is guaranteed against faulty workmanship and materials for a period of two (2) years from the date of installation.
4. Schneider Electric reserves the right, at its discretion, to either repair free of parts and labour charges, replace or offer refund in respect to any article found to be faulty due to materials, parts or workmanship.
5. This warranty is expressly subject to the Schneider Electric product being installed, wired, tested, operated and used in accordance with the manufacturer's instructions.
6. All costs of a claim shall be met by Schneider Electric, however should the product that is the subject of the claim be found to be in good working order all such costs shall be met by the claimant.
7. When making a claim the consumer shall forward the Schneider Electric product to the nearest office of Schneider Electric with adequate particulars of the defect within 28 days of the fault occurring. The product should be returned securely packed, complete with details of the date and place of purchase, description of load, and circumstances of malfunction.

## 8.0 Technical and Sales Support

For assistance with technical problems, contact your nearest Schneider Electric sales representative.

Australia  
Schneider Electric (Australia) Pty  
33-37 Port Wakefield Rd, Gepps Cross,  
5094, South Australia  
Freephone 1300 20 25 25 Telephone +61 8 8269 0511  
Freefax 1300 20 25 56 Fax +61 8 8340 1724  
Technical Support 1300 722 247  
[www.schneider-electric.com.au](http://www.schneider-electric.com.au)

New Zealand  
Schneider Electric (NZ) Ltd  
38 Business Parade South, Highbrook,  
East Tamaki, Manukau 2013  
Telephone +64 9-829 0490  
Fax +64 9-829 0491  
Customer Care Tel. 0800 652 999  
[www.schneider-electric.co.nz](http://www.schneider-electric.co.nz)

**Schneider Electric (Australia) Pty Ltd**

Contact us: [schneider-electric.com.au/contact](http://schneider-electric.com.au/contact)

**National Customer Care Enquiries:**

Tel 1300 369 233

Fax 1300 369 288

**[schneider-electric.com.au](http://schneider-electric.com.au)**

Schneider Electric (Australia) Pty Ltd reserves the right to change specifications, modify designs and discontinue items without incurring obligation and whilst every effort is made to ensure that descriptions, specifications and other information in this catalogue are correct, no warranty is given in respect thereof and the company shall not be liable for any error therein.

© 2011 Schneider Electric. All Rights Reserved.  
Trademarks are owned by Schneider Electric Industries SAS or its affiliated companies.

CLIPCOM 00000 April 2015

**Schneider**  
 **Electric**™

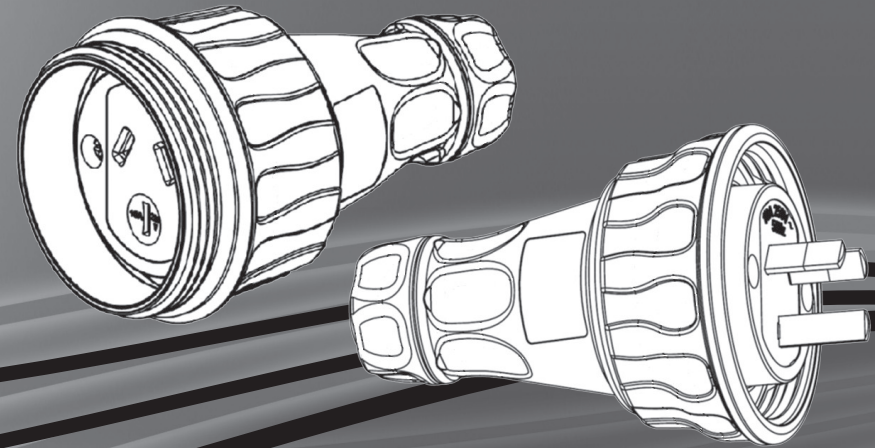

**IP66 Plugs & Socket  
Connectors**  
EY56P, EY56CSC  
Series

Easy56 

Installation Instructions

REGISTERED TRADE MARK

# 1.0 Introduction

This document is intended as a reference guide to installing a Schneider Electric Easy56 EY56Pxxx Plug or EY56CSCxxx Socket Connector.

This document is intended to provide accurate information. No responsibility is assumed by Schneider Electric for any consequences arising from use of this document.

# 2.0 Safety

## **⚠ DANGER**

### HAZARD OF ELECTRIC SHOCK, EXPLOSION, OR ARC FLASH

- This equipment must only be installed and serviced by appropriately qualified and/or licensed electrical personnel
- Isolate the electrical supply before doing any work on this equipment
- Ensure that the product has been correctly installed and tested for safe operation before reconnecting the electrical supply
- All wires are clamped between the moving nut and the fixed pin. DO NOT wrap wires under head of screw.

**Failure to follow these instructions will result in death or serious injury.**

Note: Severe penalties apply if electrical equipment is not installed and serviced by appropriately qualified and/or licensed electrical personnel.

A qualified person is one who has skills and knowledge related to the construction, installation and operation of electrical equipment and has received safety training to recognize and avoid the hazards involved.

# 3.0 Single Phase 10A & 15A Plug & Socket Connector Detail

RECOMMENDED FLEXIBLE CORD SIZE		
Catalogue Number	Diameter (mm)	Cord Size Range
EY56P310, EY56CSC310	Min 6.8	0.75mm <sup>2</sup> ORDINARY DUTY
	Max 10.6	1.0mm <sup>2</sup> HEAVY DUTY
EY56P315, EY56CSC315	Min 7.4	1.5mm <sup>2</sup> ORDINARY DUTY
	Max 10.6	1.5mm <sup>2</sup> HEAVY DUTY

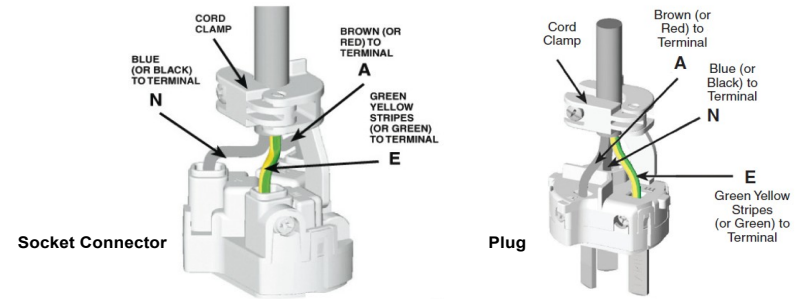
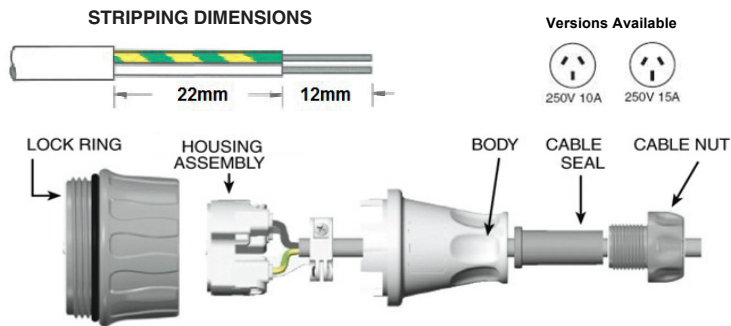

# 4.0 Single Phase 20A & 32A and 3 Phase 10A to 32A Plug Detail

## 4.1 Gland Size Selection & removal of rings

For 10A to 20A (EY56P320, EY56P410, EY56P420, EY56P510 & EY56P520)

For 32A (EY56P332, EY56P432 & EY56P532)

Cable Size mm <sup>2</sup>	Number of cores in cable				
	3	4	5	6	7
1.0	0	1	1	1	2
1.5	1	1	2	2	3
2.5	2	2	2	3	3
4.0	2	3	3		

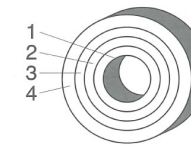

Cable Size mm <sup>2</sup>	Number of cores in cable		
	3	4	5
4.0	1	1	2
6.0	2	2	3
10.0	4	4	5
16.0	5	5	

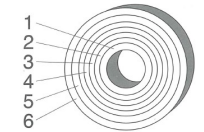

Remove all the rings up to and including the number corresponding to the selected cable size. To remove the rings use a knife or small pliers:



## 4.2 Stripping Details for All Conductors Including Earth

**For 10A to 20A (EY56P320, EY56P410, EY56P420, EY56P510 & EY56P520)**

Recommended for use with 1mm<sup>2</sup> 3 core to 4mm<sup>2</sup> 5 core ordinary duty circular flex.

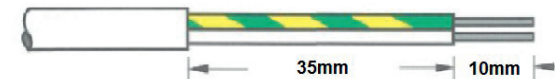

**For 32A (EY56P332, EY56P432 & EY56P532)**

Recommended for use with 4mm<sup>2</sup> 3 core to 16mm<sup>2</sup> 4 core ordinary duty circular flex.

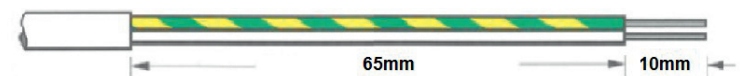

## 4.3 Terminal locations & plug layout

