

Wireless Alarm System User Manual

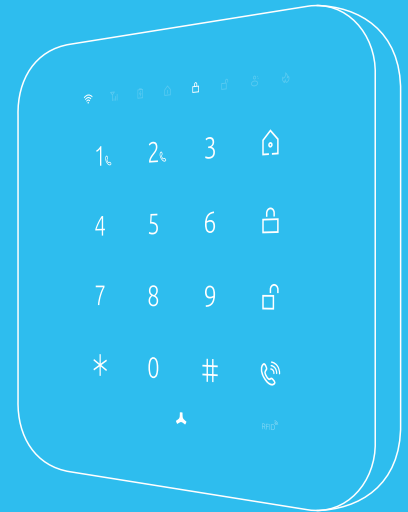

17 Millicent Street, Burwood, VIC 3125 Australia
Tel: 1300 772 776
info@intellink.com.au
intellink.com.au



Content

- 01 Product list
- 02 Features
- 03 Working Status of Control Panel
 - [Quick Start Guide](#)
- 06 Installation of The Control Panel
 - [Included Accessories](#)
- 09 PIR Motion Detector
- 12 Door/Window Sensor
- 14 [Connect Alarm System to the App](#)
- 14 [Mobile App Setup](#)
- 18 [Alarm System Dashboard](#)
- 21 [How to Use the Alarm Keypad](#)
- [Accessories Management](#)
- 23 Accessories Enrollment
- 25 Configure the Accessories
- 26 Zone Setup
- 27 [Recent Activity](#)
- 28 [Notification Rules](#)
- 29 [Electrical Facility Control](#)
- 30 [Phone Remote Control Setup](#)
- 31 Device Setup
- 36 Programming by Alarm Keypad
- 37 Other App Setting
- 38 Scene
- 40 Connecting Wired Accessories & Linkage Electronic Facilities
- 41 [SMS Text Operation](#)
- 42 [Specification](#)
- 45 [Q & A](#)

The dual network security system is built to offer convenient, real-time monitoring and flawless home security. It protects your home 24/7. The control panel is the brain of security alarm system, which is able to communicate with all wireless sensors. If an intrusion is detected or if an abnormal amount of smoke is detected, it triggers an immediate alarm and send you notification by SMS, push notification and calls. **SMS notifications, calls & monitoring station function requires SIM card which is not included in kit**

Product List

Please remove all supplied contents from packaging as below. If there're anything missing, please return to your place of purchase.

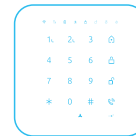

Control Panel

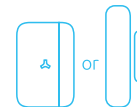

Door/Window Sensor



P.I.R. Motion Detector

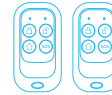

Remote Control



RFID Card



Wall-mounted Bracket



Bracket for Motion Detector



3M Double-sided Tape



Batteries



Plastic Plugs & Screws



User Manual



Power Adapter



Features



Totally Wireless,
DIY Installation



105dB Siren



24 Hours Protection



Entry/Exit Delay



Wi-Fi + GSM,
Double Safety



FHSS Frequency-Hopping
Spread Spectrum



Immediate
SMS Alerts



3 Groups of SMS
5 Groups of Phone Call
2 Groups of Central
Monitoring Station



6 Hours
Battery Back-up



10 Customizable
Keyfob Name



Added on up to
50pcs Sensors



Door Sensor
Monitoring



50 Zone Names



iOS & Android App,
Easy to Setup



Working Status of Control Panel

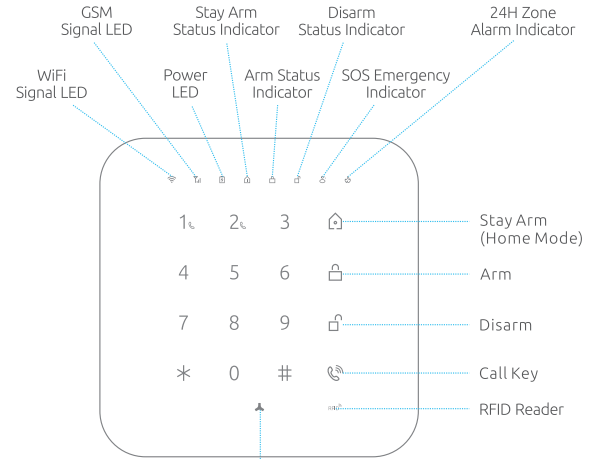





Wake up Key

Press "▲" icon to wake up the touch keypad

Zone Alarm Indicator

LED comes on when normal zone sensors are triggered.

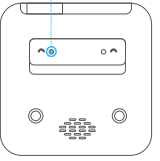
Escape Key

| No | Name | Function |
|----|--|--|
| 1 |  GSM Signal Status LED Indication | Flashes quickly: No SIM card or no signal Flashes normally: GSM network found |
| 2 |  Wi-Fi Status LED Indication | On: Wi-Fi network connected. Off: Wi-Fi network lost. Flashes quickly: Start setup with the app in smart configuration. Flashes slowly: Start setup with the app in AP configuration. |
| 3 |  Power LED Indication | On: Power on Off: Power off Flashes: System in low battery |
| 4 | <p>Button Tamper Button</p>  | <p>Tamper Button Press Once: Trigger tamper alarm</p> |
| 5 |  Touch Keypad | <p>Touch Keypad Password*0# : Delete all the enrolled accessories. Password*1# : Start enrollment with the new accessories. Press*and hold for 5 seconds : Start setup with the app. Password*3# : Reset the system to factory setting.</p> |

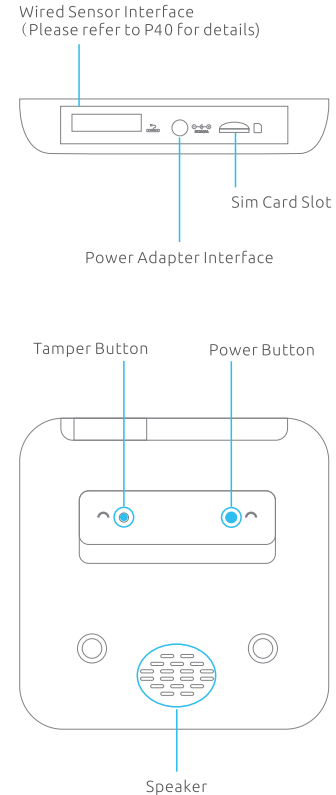



Quick Start Guide

1. Installation of The Control Panel

- Insert a SIM card and fix it.
- Insert power adapter's barrel plug to adapter socket.
- Press the switch button.
- Test the enrollment of accessories.

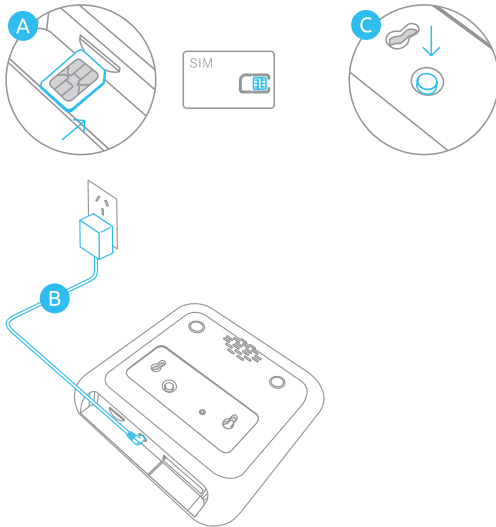

Important:

The sim card you have purchased may not ask for a PIN. However should your SIM card requested a PIN, you can switch off the PIN request by briefly using the SIM card in a mobile phone.

After testing, screw the mounting bracket to the wall, connect the panel to the bracket.

2. Using and Testing the Remote Control(s)



- Press the panic button " SOS ". A small display on the remote control will briefly light up. A loud alarm tone will immediately sound and the symbol on the control panel will flash red .
- Turn the alarm off again by pressing the disarm " 🔒 " button. Congratulations!
Your remote control(s) are working!

3. Using and Testing the Door Sensor



- Pull out insulating strip.



- Arm the system with " 🔒 " button.



- Now separate both parts of the sensor and hold them at least 2cm away from one another. A red light will briefly flash on the sensor



- As soon as the alarm sounds, disarm the control panel with " 🔓 " on the remote control. Congratulations.
The door sensor is now working!

4. Using and Testing the Motion Detector



A. Carefully open the cover of the motion sensor by pressing the clip and pull out insulating strip.



B. Fix the cover by the short screw.



C. Arm the system with “” button.



D. Now press the small, black button (program) on the rear of the motion sensor.



E. As soon as the alarm sounds, disarm the control panel with “” on the remote control. Congratulations.
The motion sensor is now working!



F. Using RFID Cards
You can disarm the security system by placing it close to the “RFID” area on the touch keypad. The RFID Cards can be featured of arming, disarming or both which can be selected on



Wireless P.I.R Motion Detector

Features

The passive infrared sensor with novel and beautiful style, perfect streamline can be easily installed. It is designed to detect human movement indoor. Adopted advanced fuzzy logic chip and intelligent analysis distinguish signal between body movement and interference to minimize false alarms. The built-in buzzer remind you low battery state and event of tamper alarm, which ensure your safety.

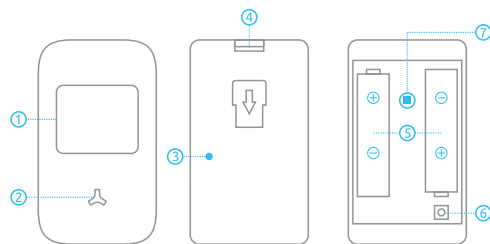

1. Detection Window
2. LED Indicator
3. Learning Button
4. Clip
5. Battery Compartment

6. Tamper Switch
7. Infrared Sensor

Infrared Sensor: Detects the infrared rays released by human body motion. Please do not touch the surface and keep it clean.

Tamper Switch: Once the case is opened, the tamper switch will be triggered, generating an alarm signal.

Status Indicator



LED Flashed Once:

Movement is detected, Tamper alarm.

LED Flashes Once each 3 seconds:

Low battery indication.

If it's in low battery state, please replace it immediately.

Installation & Walk Test

With the Detector powered on, the light should turn on immediately and will keep flashing while the sensor warms up, for approximately 15 seconds. It will then turn off.

Test Mode: After warm-up, walk through the coverage area and the light should turn on. This confirms that the movement is detected. The detector will recognize the movement 5 times. The interval time between each detection should be more than 2 seconds. Then it enters in sleeping mode.

Sleeping Mode: In this mode, the sensor detects motion constantly, but will only trigger the alarm on the first two detections. After 3 minutes, the sensor will reset ready to trigger the alarm. The mode helps save considerable amounts of energy when the house or apartment is inhabited and people are constantly moving around.

Walk Test:

After the sensor warm up, walk across detection area and watch the LED indicator to make sure it flashes once when detecting the movement.



Notice

1. Avoid mounting the detector close to places where heat changes fast or air stream flows frequently. (ie. Air conditioner, tube light, oven, waver, refrigerator etc.)
2. Avoid it facing to window which can be easily interfered by complicated environment. (ie. sunlight, crowds, or flowing cars etc.)
3. The product can reduce the possibility of accident, but the user is advised to take all necessary precautions for the safety and the protection of the property.

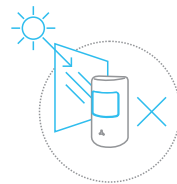

Detection Area

Top View

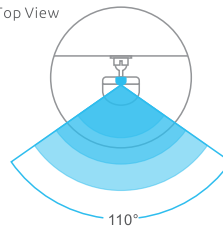

Side View

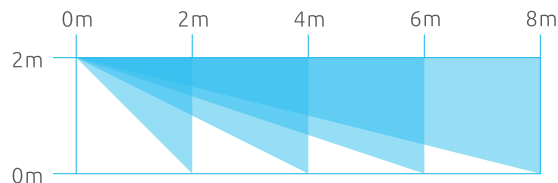
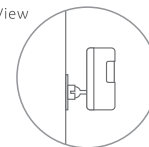



Wireless Door/Window Sensor

The Door/Window Sensor can be installed on doors, windows and any other objects that open and close.

The sensor transmits signal to control panel when the magnet mounted near the sensor is moved away.

The tamper protection ensures that sabotage attempts to move the sensor will result in an alarm activation.

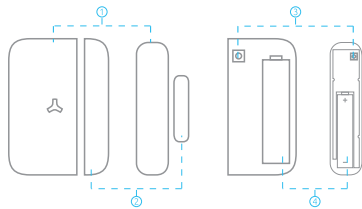
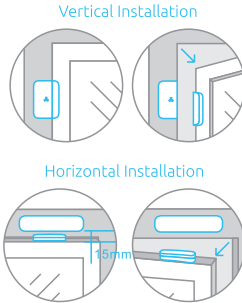

1. Transmitter
2. Open-close magnet
3. Tamper Switch
4. Battery Compartment

Tamper Alarm: Once intruder attempts to move the sensor, built-in buzzer beeps. The control panel will send tamper alarm message to user at the first time.

Working Status:



LED flashes once:

Door or window is opened, and the transmitter sends signal to the control panel. Tamper alarm.

LED Flashes Once each 3 seconds:
Low battery indication.

If it's in low battery state, please replace it immediately.

Installation:

1. Open the case and install the battery properly.
2. Sensor can be installed on door or window that open and close. Make sure the installed position have been already cleaned.
3. Remove the paper strip of the double-sided tape on the back of transmitter and magnet. Carefully mount the transmitter on the door frame and the magnet on the door.
4. Keep LED Indication light  at the right direction. Make sure the magnet is on the right of the transmitter.
5. Place the transmitter in the desired location, mount the magnet no more than 1cm away from the transmitter.
6. Avoid mounting sensors in areas with a large quantity of metal and electric wiring.

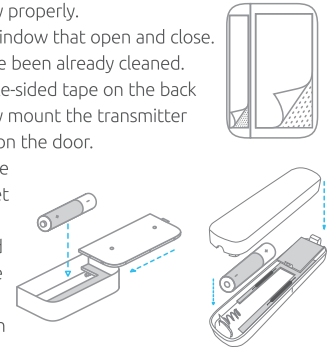

Note! The door sensor is set in Normal Zone1 as default. It will cause an immediate alarm if the magnet departs from the transmitter more than 2cm in arming state.

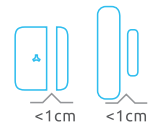

Download App

Please enter keyword **"IntelLink"** on your smart phone to download the App from the Apps store or Google Play.



IntelLink App

Wi-Fi Network: 2.4GHz (802.11 b/g/n).

iOS Requirements: iPhone 4S or newer running iOS 8 or higher.

ANDROID Requirements: Android 4.0 or newer.

Create an Account

Tap on **"Register"** and follow these steps to create an account for your devices.

Connect Alarm System to the App

Add Device

Tap on **"Add Device"** or **"+"**

A. Bluetooth Fast Pair

The app is searching for nearby Bluetooth devices.

1. Tap on **"Add"** to connect when the device photo show up.

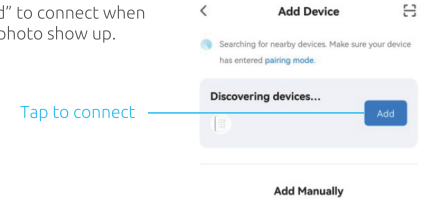

2. Enter Wi-Fi network and password, then tap on **"Next"**

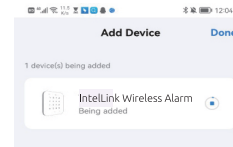
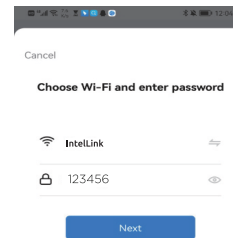

3. Device added successfully. Then you can rename the device and choose where you place the device.

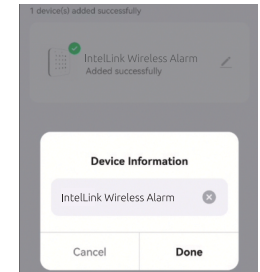

B. Configure by selecting the category

1. Tap on "Security" and choose IntelLink Wireless Alarm

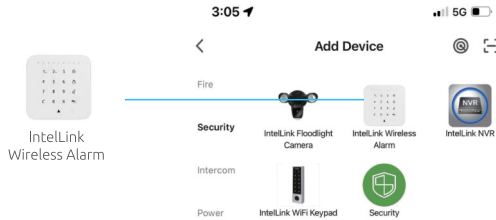

2. Select 2.4G Wi-Fi network and enter your Wi-Fi password.

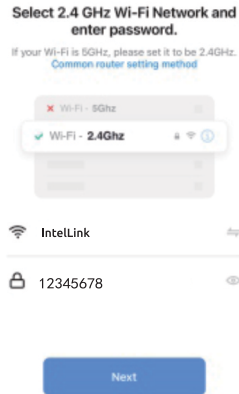

3. Turn on the device and confirm that Wi-Fi Status LED "Wi-Fi" of the device flash quickly.

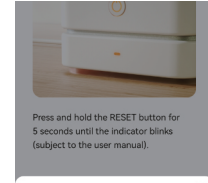

How to make Wi-Fi Status LED "Wi-Fi" flash quickly?
* Turn on the device, then press the "Wi-Fi" button for 5 seconds

Select the status of the indicator light or hear the beep:



4. Waiting for seconds while connecting.

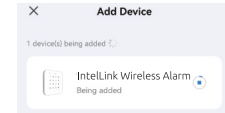
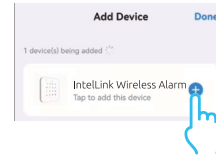

5. Device added successfully. Then you can rename the device and choose where you place the device.

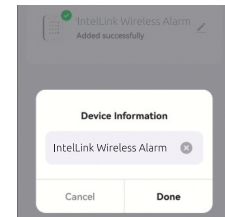



Alarm System Dashboard

Once the alarm system has been connected to your app, the dashboard will be displayed.

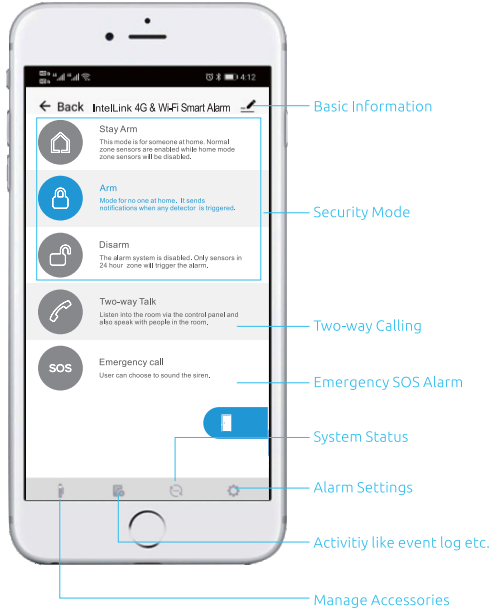

Basic Information

Security Mode

Two-way Calling

Emergency SOS Alarm

System Status

Alarm Settings

Activity like event log etc.

Manage Accessories

The Alarm System has three security modes and an emergency SOS button.



Arm

Arm the system when leaving your home. All sensors will be activated. Any sensors that are triggered will immediately sound the alarm.



Disarm

Disarm the system when entering your home. All sensors will be deactivated allowing you to move freely .



Two-way Talk

Listen into the room via the control panel and also speak with people in the room.



Stay Arm (Home Mode)

Sensors that are designated in the Home Zone are deactivated, allowing you to move freely in your home. the sensors in Normal Zone will remain active and if triggered, will immediately sound the alarm.



Emergency Call

Press the SOS button in the event of an emergency. This will trigger an immediate alarm even if the system is disarmed or in Home Mode. To stop the alarm, press the disarm button on the app or remote control.



Mute Mode

Press stay arm button, then press arm or disarm button within 3 seconds to enter into arming or disarming state in mute mode without disturbing someone.

(Note: Mute Mode only works for operation via Remote Control.)

4 Ways to Control the Alarm System

Using Touch Keypad

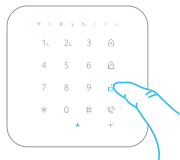

Tap on device "1", enter the device interface.

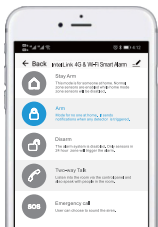

Using RFID Cards



Through the Remote Control (Press and hold the buttons for about 1 sec.)



You can arm, disarm and switch between security modes using:

- 1.Touch keypad on alarm control panel
- 2.RFID Cards
- 3.IntelLink Apps
- 4.Remote Control



How to Use the Alarm Keypad

Wake up Key

Press "▲" icon to wake up the touch keypad.

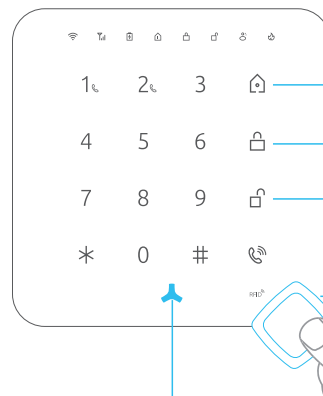

SOS Emergency Button
Press and hold activate key "▲" to immediately trigger the alarm.
(Mute Mode only works for operation via Remote Control.)

Stay Arm:

Press "▲" once, enter password 1234, then press "▲".

Arm:

Press "▲" once, then press "▲".

Disarm:

Press "▲" once, enter password 1234, then press "▲".

RFID Reader:

Place it close to the RFID reader to arm or disarm. The Function (Arm only, Disarm only, Arm or Disarm Switchable) can be setup on the app. See page 25.

Arming and Disarming

Disarming and arming stay always need a password. The default password is "1234" and can be changed by using the apps. (Check Page35, [Setting-Security Code For Disarming](#))



admin password



Make a call

Wake up the touch keypad, type in the phone number, and then press the Call Key "☎" to start the call.



Speed Dialing

The system allows you to program up to 2 frequently called phone numbers reduced to a single digit (1 or 2).

To store speed dial numbers:

Open the app, enter Alarm System Dashboard > [Setting](#) > [Store Alarm Phone Number](#) > [Speed Dial Numbers](#) > [Enter the numbers to store](#) > [Save](#)

To dial speed dial numbers:

Wake up the touch keypad, then press and hold the number 1☎ or 2☎, the number will be dialed immediately.



Note: If you enter the wrong numbers, tap the wake up key "☎" to erase the numbers and call again.



+ Accessories Management

Tap on "🔑 Accessories" icon then into accessories menu, you can customise the accessory name, select the zone type, and also delete the accessory from the app, if required.

Accessories Enrollment & Zone

You are able to pair up to 50 additional sensors, 50pcs RFID cards, 10 remote controls or keypads to the alarm system. Sensors that are included with the alarm system are already enrolled with the control panel. More accessories can be paired in two ways.

Press the enroll button .

Step 1, Press the enroll code on touch pad or select the "🔑 Accessories" on the dashboard to enter the Accessories Menu, then tap on "➕ Add" icon.

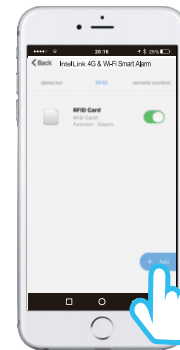

Input "XXXX*1#" (XXXX is password, the default password is 1234)



Step 2, Trigger the sensors one by one. How to trigger different accessories:

Sensors



Press the black button on the rear of the motion sensor.

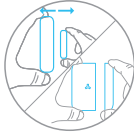

Move the transmitter away from the magnet.



Press any button on the remote control.

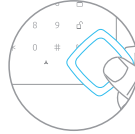

Place RFID card close to the RFID reader.

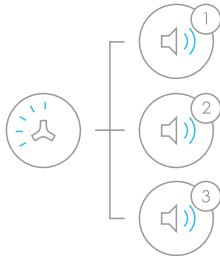

1 System beeps once, the LED light flashes once, the enrollment is successful.

2 If system beeps twice and the LED light flashes once, the accessories have been enrolled before.

3 If three beeps are heard and LED light flashes once, the storage is full.

(Note! Please don't press tamper switch to enroll or enroll accessory in low battery status. It will remain in enrolling mode for 30 seconds.)

Step 3, Press the enroll button again or press "X" icon on the app to exit the enrolling. The enrolled sensors will automatically appear in the Accessories menu in the app.

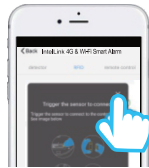

Configure the Accessories

Tap on "Accessories" icon on the dashboard to enter the Accessories menu.

You are able to enable and disable accessories from this page. We recommend that you give each accessory a unique name so it is easier to recognise the location should an alarm be triggered.

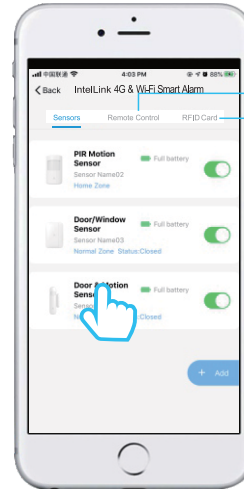

You can also assign each sensor to a Zone Type (see page 26) To configure any accessory, simple press the accessory name.

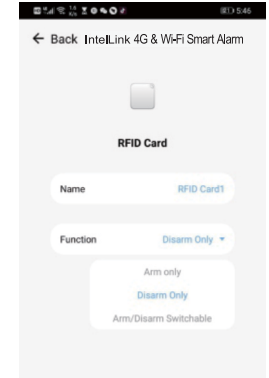

Name the Remote Control or RFID tags, so you will receive the alerts that tell you whose remote control or RFID tags has armed or disarmed the Alarm System.



Zone Setup

 : Full power,
 : Low Battery

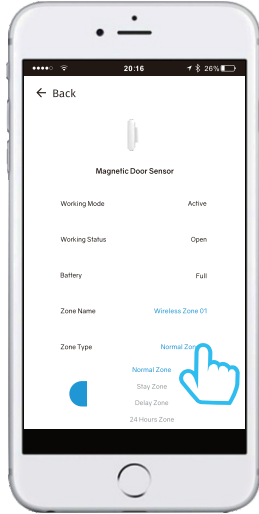

Normal Zone

The alarm is activated immediately when triggered.



Delay Zone

It allows a delay before entry or exit especially for sensors in single delay zone. But accessories in normal zone, home mode zone, and 24H zone will not be delayed.



Stay Zone

Press " " button, sensors in home mode zone are disabled then the users can move freely. While the sensors in normal zone will still activate an immediate alarm when triggered.



24 Hour Zone

No matter what state the alarm system is in, the accessories in 24 Hour zone are triggered, the control panel will get the signal and alarm immediately.



Recent Activity

The alarm system monitors your home for activity and sends you an app push notification, calling or SMS when sensors are triggered. All events can be checked by tapping on "[Recent Activity](#)".

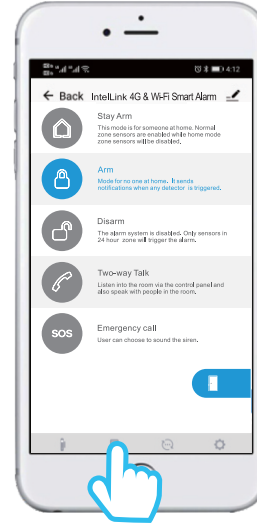

Notification Rules

| | Push Notification | SMS | Call | Mark |
|-------------------------|-------------------|-----|------|--|
| Smart Alarm WiFi ON | ✓ | ✗ | ✓ | Call phone number 1,2,3,4,5 If anyone pick up the phone, then it will stop calling next. If anyone disarm by clicking on button from notification window, then the call ends too. |
| Smart Alarm WiFi OFF | ✗ | ✓ | ✓ | Call phone number 1,2,3,4,5 If anyone pick up the phone, then it will stop calling next. |

Note: If no one pick the phone, the system will keep dialing for 3 times.

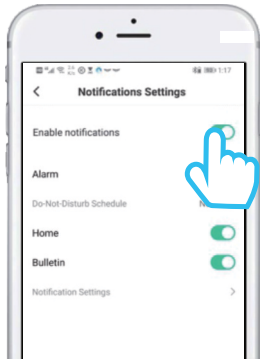

If "Me-Setting-App Notification" is disabled, then you will not receive app notification when events are detected but still have calling alert or SMS alerts.



Electrical Facility Control

Tap on "  " to turn on electronic facilities like lights, or fences to deter the intruder immediately in the event of alarm.

Note! Electrical Facility is Off as default. To activate electrical facility, AC power of control panel must be on.

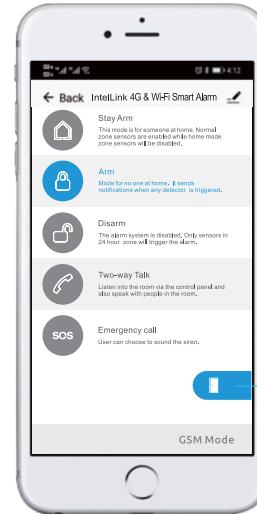

The alarm supports external sensors and door lock. You must switch the alarm power on to activate other external sensors connected.

Tap to unlock door/gate
See page 40 for connection details.



Phone Remote Control

In the event the alarm, the alarm system will call the preset phone number, user can pick up the phone , monitor the site, and remotely control system by entering below numbers.

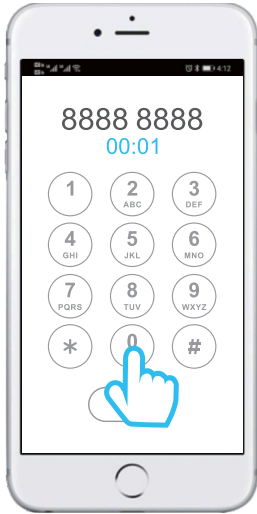

- Disarm the system, press 0;
- Arm the system in the away mode, press 1;
- Turn on on site siren, press 7;
- Turn off on site siren, press 8;
- Monitor the site, press * key;
- Press escape (#) or hang up to exit.



Device Setup

Tap on "  Setting ", enter the setting interface.



Google Home Security Code

- Use the security code to disarm the alarm system via Google Home.
- Voice Control for Google Home :
- Disarm "device name".
- Set "device name" to home mode
- Set "device name" to away mode



Store Alarm Phone Numbers

- Add phone numbers you want to control over. These numbers consist of three SMS numbers (receiving security messages and alerts), five Tel numbers (receiving alarm calls), and two CMS numbers.
- It's recommended to set the numbers according to the priority.



Central Station Setting

- The system support Ademco Contact ID and SIA TCP/IP protocol
- It's able to communicate alarms and events directly to the Central Monitoring Station. The phone number of alarm system should be filled on the setting menu.

Note : Communication of events in SIA DC-09 format is feasible if the CMS software supports this protocol.

Connect the alarm panel to the central monitoring station by using the SIA protocol



← Back Central Station S...

Connect with Central Station Enable Connect with Central Station

Protocol Select CONTACT ID or IP(SIA Protocol).

User Account Number: Enter the account number of alarm panel, specify the central station tel number or the primary and secondary IP address of the CMS.

Setting



← Back Central Station S...

Access Point Names(APNs)

Access Point Names:

User Name: Password:

Authentication type: CHAP

APN protocol: IPv4

Periodic Test 1 Min

Test the heartbeat interval time at the alarm center
The heartbeat time between the device and the CMS server can be set up to 4 hours.
Minimum can be set for 1 minute

Encryption Configure reception of events on the CMS and specify the encryption key if you intend to use encryption. The encryption key may contain up to 32 HEX or 16 ASCII characters.

Encryption Key: 000000



Schedule

Schedule the arming and disarming of your security systems at your convenience. Time tolerance may be about +/- 30 seconds.



Exit/Entry Delay

Set exit/entry delay time for accessories in single delay zone. It allows users to leave or enter home within the programmed time without activating an instant alarm. Once entry/exit delay time is set, when system is armed, in case of delay time less than 10 seconds, control panel will beep once every second. While delay time more than 10 seconds, control panel will beep once every 2 seconds, the sound will increase in tempo for the last 10 seconds for the "hurry up" notification. Once an entry is detected, it will allow the user to enter and disarm the system within the programmed entry time.



GSM Signal Monitor

When the GSM signal is lost, the system will raise an alarm. When GSM signal is lower than 20, the system will send SMS notification.



Remote Control Armed/Disarmed Alert

When the system alarms, users can choose whether to get push notifications and SMS alerts if someone operates it via keyfob. Get notified who is operating the system via remote control.



RFID Card Operation Notification

Get notified who is operating the system via RFID tags.



Door Sensor Monitoring

Be notified if a Door/Window has been left open when the Alarm System is armed.



Wired Sensor Type

Choose the types of wired sensors after they are connected, N.C. or NO.



Alarm Type

User can set the siren to be audible or silent when it's alarming.



Local Siren

When you turn on the local siren, the control panel will alarm immediately.



Siren Duration Time

User can set the siren duration From 0s to 300s, the device will be in mute when user set it 0s.



Device Language

Change system language as you want.



Sim Card Balance

Send balance check code via SMS to the card operator.



Security Code for Disarming

The security code is used to control the system by using touch keypad or sending SMS(should be 4 digits)



Phone Number of Alarm System

Add phone number of the one you insert in the alarm system.



Programming by Alarm Keypad

Each system installed will require programming, by app or using the alarm system keypad. Use the following outline if you program the system by using alarm keypad. Enter the password followed by * to start the setup. (default password 1234.)

| Code | Functions | Mark |
|----------------------|--------------------------------------|---------------------------------------|
| Password*0# | To delete all enrolled accessories. | |
| Password*1# | Enter Accessories Enrollment State | |
| Password*2# | Start Setup with the app. | |
| Password*3# | Reset the system to default setting. | |
| Password*5*1*xxx# | Set Alarm Duration Time in Minutes | "xxx" refer to minutes values |
| Password*5*2*xxx# | Set Exit Delay Time | |
| Password*5*3*xxx# | Set Entry Delay Time | |
| Password*6*1*xxxxxx# | Store Speed Dailing Number 1 | "xxxxxx" refer to mobile phone number |
| Password*6*2*xxxxxx# | Store Speed Dailing Number 1 | |
| Password*7*1*xxxxxx# | Store SMS Number 1 | |
| Password*7*2*xxxxxx# | Store SMS Number 2 | |
| Password*7*3*xxxxxx# | Store SMS Number 3 | |
| Password*8*1*xxxxxx# | Store Phone Number 1 | |
| Password*8*2*xxxxxx# | Store Phone Number 2 | |
| Password*8*3*xxxxxx# | Store Phone Number 3 | |
| Password*8*4*xxxxxx# | Store Phone Number 4 | |
| Password*8*5*xxxxxx# | Store Phone Number 5 | |



Other APP Settings

 My home

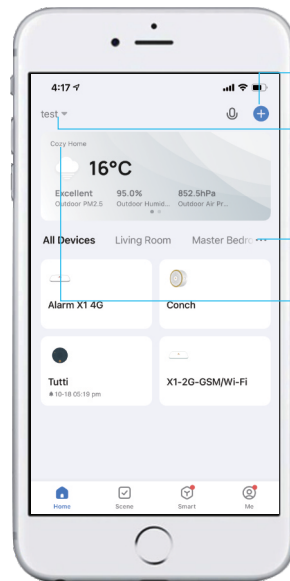

• Add devices

• Home Management
Family settings: Name change/
Room management/Family
location/ Share advices
Add Family/Add rooms.

• Room Management
Add/Delete/Edit rooms

• Set Home Location

Scene

Tap on "  " to add smart scene or automation of your connected devices.

For example, arm the system, and turn off the smart bulb.
Or disarm the system, and then turn on the smart bulb.
Or to excute the actions according to different conditions. For example, when temperature greater than 40°C, trigger the alarm system.

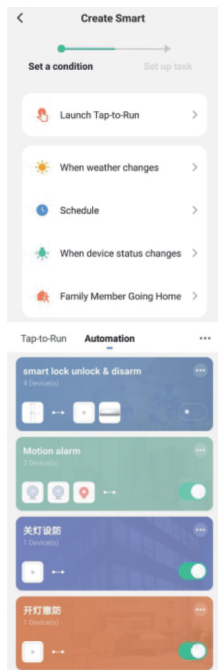
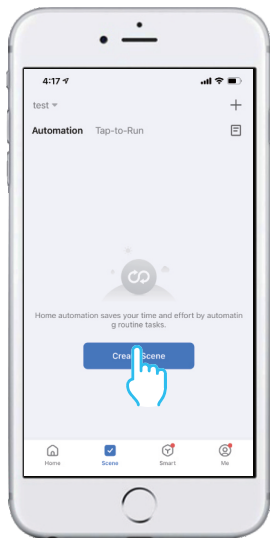

Me

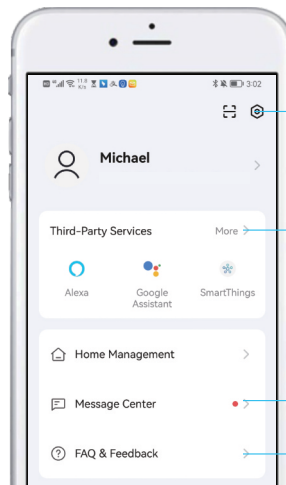

Sound: Turn on/off the sound of the key on APP.
Notification: Receive the push notification or not.

Sound

Push Notification

Add other services, like Alexa...



Check the activities of the system

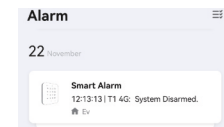

Write down and send us your issues or complaints or any feedback.



Connecting Wired Accessories & Linkage Electronic Facilities

Connecting Wired Accessories

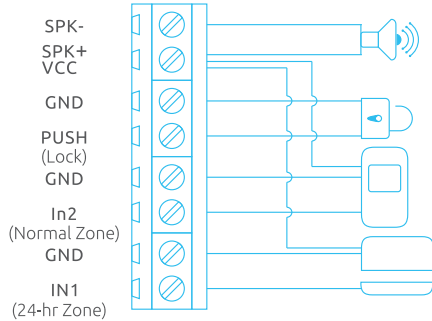

1. Connect one wire to IN1 or IN2 block while another to GND block. If no power supply is needed for wired sensor, don't connect to VCC block.
2. Connecting Wired Siren or strobe light. Connect THE Positive terminal to SPK+ while the Negative terminal to SPK-
Note: The maximum current of the device should not more than 500mA.
3. Connect PUSH and GND of electronic lock.

! Note: Wired Zone 1 is 24H Zone. No matter the system is armed or disarmed, the control panel will get the signal and alarm immediately once it is triggered. Wired Zone 2 is Normal Zone. Once triggered in arm state, the system will receive signal and activate the alarm immediately.



SMS Text Operation

If the Wi-Fi internet ever drops out, the GSM unit will quickly take over and send signals out. It's recommended to use mobile apps to control the system even when the system works in GSM mode. And it's easy for users to manage functionality through your cell phone by sending SMS text commands listed as below.

| Function | SMS Text Operation | | |
|---------------------|---|----------------------------|--|
| | Send this operation code from your cell phone | SMS reply you will receive | Remark |
| Disarm | 1234#0 | System Disarmed | --- |
| Arm | 1234#1 | System Armed in Away Mode | --- |
| Stay Arm | 1234#2 | System Armed in Stay Mode | The Arm/Stay function will arm the system with sensors in normal zone activated immediately, but sensors in home mode zone disabled. |
| SOS Button | 1234#SOS | Emergency Call ! | Trigger the immediate alarm ! |
| Electrical Facility | 1234#91 | Electrical Facility on | To activate electrical facility, AC power of control panel must be on. |
| Two-way Talk | 43 | --- | Send "43" to the SIM card number, the control panel will call back. You can now listen in and have a two-way talk. |



Specifications

| | |
|---|---|
| Product Name : | Wi-Fi & GSM Alarm System |
| Control Panel's Power Supply : | Input: AC 110~240V/50~60Hz Output: DC 12V/1000mA |
| GSM Working Frequency : | 3G/4G |
| Standby Current : | 200 mA without power supply. 150 mA when power supply on. |
| Alarm Maximum Current | ≥350mA |
| Internal Battery Backup : | Lithium Battery: 3.7V/1000mAh |
| Internal siren : | 105dB |
| Allowed Amount of Expandable Wireless Accessories | 10pcs remote controls 50pcs wireless accessories 30pcs RFID cards |
| Operating Frequency: | 2.400~2.4835GHz |
| Wi-Fi Standards: | 802.11b/g/n |
| Radio Frequency | FHSS 433MHz |
| Housing Material | ABS plastic |
| Operation Condition: | Temperature: -20°C~55°C Humidity: ≤ 80%(non-condensing) |
| Size (L x W x H) : | 135×135×25mm |
| Bracket Size (L x W x H) : | 83.5×27×3mm |



Specifications

| | |
|---------------------------------|---|
| Power Supply: | DC1.5V (AA 1.5V Lr6 Battery x1)(EXCELL, GP) |
| Standby Current: | ≤25 μA |
| Transmit Current: | ≤70mA |
| Wireless Transmit Distance: | ≤100m (in open area) |
| Wireless RF Frequency: | FHSS 433MHz |
| Temperature/Humidity: | -10°C~55°C/≤80% (Non-condensing) |
| Detector Dimensions(L x W x H): | 24.5 x 96.5 x 19.5 mm |
| Magnet Dimensions (L x W x H): | 14 x 48 x 11 mm |



Specifications

| | |
|-----------------------------|---|
| Power Supply: | DC1.5V (AA 1.5V Lr6 Battery x1)(EXCELL, GP) |
| Standby Current: | ≤20 μA |
| Transmit Current: | ≤70mA |
| Wireless Transmit Distance: | ≤100m (in open area) |
| Wireless RF Frequency: | FHSS 433MHz |
| Temperature/Humidity: | -10°C~55°C/≤80% (Non-condensing) |
| Dimensions (L x W x H): | 48 x 71 x 18mm |



Specifications:

| | |
|------------------------------|--|
| Power Supply: | DC 3V (AA 1.5V LR6 Battery x 2pcs)(EXCELL, GP) |
| Standby Current: | ≤20 μA |
| Transmit Current: | ≤30mA |
| Detection Area: | 7-8m/110° |
| Wireless Transmit Distance: | ≤100m (in open area) |
| Wireless RF Frequency: | FHSS 433MHz |
| Temperature/Humidity: | -10°C-55°C/≤80% (non-condensing) |
| Detector Dimensions (LxWxH): | 90x 52x 36.5mm |
| Bracket Dimensions (LxWxH): | 48x 26x 29mm |



Specifications:

| | |
|-----------------------------|--|
| Power Supply: | DC 3V (CR2032 button cell batteries x 2 pcs) |
| Transmit Current: | ≤25mA |
| Wireless Transmit Distance: | ≤100m (in open area) |
| Transmitting Frequency: | FHSS 433MHz |
| Housing Material: | ABS plastic |
| Working Temperature: | -10°C-55°C |
| Humidity: | Up to 80% (non-condensing) |
| Dimension(L/W/H): | 37x70x11.5mm |



Frequently Asked Questions

1. Is it possible to expand more accessories for this security system?

Yes, 50pcs sensors and 10 remote controls can be expanded according to users' need. Full range of accessories will be offered including PIR motion sensors, door sensors, vibration sensors, flood sensors, keypads, sirens, premiere protection beams & fences, and environmental sensors like smoke sensors.

2. What happens in case of alarm?

Wi-Fi alarm sends the push notification directly to your mobile apps. If there's GSM cellular for backup, when the WiFi network is offline, it will also send you the SMS and voice call. You can respond immediately via the apps, SMS, or key operation of the phone.

3. What internet connection do I need for Wi-Fi system?

All contemporary Wi-Fi standards on 2.4 GHz are supported. The Internet speed has effects on the system performance. A fast and well-functioning Internet connection is recommended for optimum performance.

4. Do I have to pay for the app?

All available IntelLink Apps are free to download (App Store or Google Play). The complete functionality is free.

5. How to download the app for the security system?

Go to App Store or Google Play to download the application by entering the keyword of "IntelLink".

6. Is IntelLink app applied to all mobile phones?

For all smartphones with a recent version of an iOS or Android operating system, this app is available to download and use. For this functionality, depending on the system, a mobile connection or mobile Internet / Wi-Fi connection is necessary.

7. What's the maximum range between the control panel and accessories?

It's 100 meters in open area. The walls might shorten the distance, it's recommended to install the accessories at the right place, and move the panel to adjust a better signal receiving. If the house is too large, it's better to add a signal repeater to boost the coverage.

8. Will my alarm system work in the event of a power failure?

Yes. The system has rechargeable back-up batteries which can support it working for 6 hours. When the power is recovered, the battery will be recharged. Adapter wire cannot be cut to make sure enough power to the panel.

9. The SIM card was installed in the control panel, but it cannot connect to the GSM cellular network.

- A. The alarm system support only GSM SIM card, SIM Card for CDMA network will not work.
- B. Make sure the system is off when you insert SIM card.
- C. Watch the bottom LED light, if the LED flashes quickly, the GSM signal is unnormal, please move the control panel near the outside wall or window to improve the signal reception.
- D. SIM card must be activated, and make sure there's enough credit in the SIM card.

10. What will happen once power is off or internet is cut?

Once power is off or network is cut, android App will be off-line after waiting 20-30seconds, it will not reconnect, you need go back to the device list, but iOS will reconnect.

11. Keypad Operation Failed

When the keypad background light is totally off, please press Wake up Key to turn on the background light then the keypad can be operated.

PIR Motion Detector

1. Why PIR Motion Detector beeps without detecting intruders?

If PIR Motion Detector beeps, and LED indicator flashes continuously, the detector is in low battery. Please change the battery immediately.

2. Why PIR Motion detector does not detect movement?

- A. Please make sure the control panel is in arming status, not at stay (home)mode or disarming status.
- B. Please make sure the LED of PIR motion detector lights up when you walk in the detection area.
- C. Movement should cross the detection and within 8 meters range.
- D. The detector enters sleeping mode to save power after 5 detection. If there's no movement within 3 minutes, the detector will reset ready to trigger the alarm.
- E. Make sure the insider battery contact well or not.
- F. Check the board put well or not.

3. If the PIR motion detector pet-immunity?

No. The PIR supplied in standard kit is normal PIR. If you have pets at home, please adjust the installing height to allow your pets to roam below the mounting height of the unit without causing alarms.

4. There's no one passerby the room, but the detector trigger the alarm

- A. Check if there's any pet at home, the PIR supplied in the standard kit is normal one, not pet-immune one.
- B. Please avoid mounting the P.I.R. motion detector at the place where rapid heat changes such as window, air conditioner, light, electric heater, refrigerator, oven, stove etc.
- C. Avoid strong sunlight.
- D. The installation height and range should be in the detection area.