

Quick Start Guide

Version 1.1
Date 18/05/2023

PIXIE

PIXIE Smart PIR Sensor Outdoor Wall Mount

SMS862WF/WH/BTAM

1. Foreword

IMPORTANT: IN THE INTEREST OF PRODUCT PERFORMANCE AND SAFETY PLEASE READ THESE GUIDE AND WARRANTY INSTRUCTIONS BEFORE INSTALLING THE PRODUCT.



SAL products are designed in accordance with all mandatory International and Australian Standards, which require installation in accordance with AS/NZS3000 by a qualified installer and regular cleaning and maintenance of the equipment. Products are sold in accordance with the following instructions and SAL standard terms and conditions of sale, available via www.sal.net.au.

Due to continued product and information updates, product data sourced from sal.net.au shall not form part of any contract and or technical performance guarantee unless expressly confirmed in writing by SAL at the time of order. The product wireframe drawings in this document are intended for illustration purposes only and may differ from the final physical product. The installation instruction is subject to change without prior notice.

2. Product Introduction

PIXIE Smart Passive Infrared Motion (PIR) sensor Outdoor Wall Mount is a new member of the continuously evolving PIXIE smart home system.

As a PIR sensor, this product is able to detect moving infrared source (typically a person) that in the detection field, and activate an electrical load, typically turning on a light, in response to that movement, so as to achieve security and energy management benefit in a wide range of domestic and commercial applications.

As a smart sensor, it's can not only working in three well-known and loved modes: Motion sensor mode (Auto), Override-On mode (Always on) and Override-Off mode (Always off), but also can work like a Photocell sensor. Switching among these modes is as simple as a tap on the App, a press on a button, or even automatically as per preset schedule.

2.1 Product Features

- 3-wire sensor, stable performance
- IP66 weather proof, suitable for outdoor application
- Extra photocell sensor function (Photocell mode)
- Mounting hole distance 84mm, can mount onto normal mounting blocks
- Parameter adjustment can be done in the PIXIE App and on the physical dial.

2.2 The package includes

- Smart Passive Infrared Motion Sensor Outdoor Wall Mounting * 1
- Accessory pack (screws, expansion bolts, caps) * 1
- Soft foam pad * 1
- Quick Start Guide * 1

2.3 Product illustration*

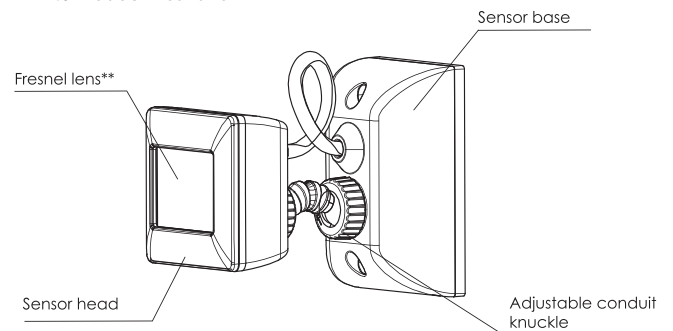

3. Specifications

Model NO.	SMS862WF/WH/BTAM	Input	220-240V~ 50Hz
Standby Power	<1W	Load Rating	<ul style="list-style-type: none"> ☼ Incandescent Max. 2000W ⚡ LED Max. 500VA Ⓜ Fan Motor Max. 120VA
Mounting height	1.8-2.5m	Detectable Movement Speed	0.6-1.5m/s
Mounting hole distance	84mm	Detection Angle	110deg
Warm-up Time	30 seconds	Detection Range	Max. 12m @24 C
Hold-Time	10 seconds to 30 minutes	Brightness Threshold	<10 - 2000lux
Ta	-10 C - 40 C	IP	IP66
Operation Humidity	10%-85% RH, NC	Storage Humidity	10%-85% RH, NC

*All drawings shown are for illustration purpose only, actual product may vary due to product enhancement.

**The sensor Fresnel lens is specially designed to give optimum performance. Do not apply any pressure on it, as this may damage the lens, and adversely affect the performance of the sensor.

Tip-Walking Direction Matters

The sensor is more sensitive to movement across the sensing pattern, and less sensitive to movement directly toward to sensor. Please plan the mounting location wisely!

4. Installation and Wiring

4.1 Installation advice

- The recommended mounting height is 1.8-2.5 meters to achieve the optimal detection range.
- Avoid objects that may be swayed by the wind, typically but not limited to curtains, tall plants etc. in the sensor detection range
- Avoid aiming the sensor toward high reflective surfaces like mirrors, monitors etc.
- Do not mount the sensor close to objects which can create rapid temperature changes, e.g. air conditioning vents, heaters, lights etc.

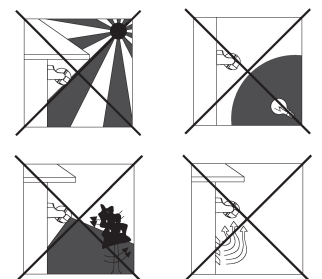

4.2 Installation direction

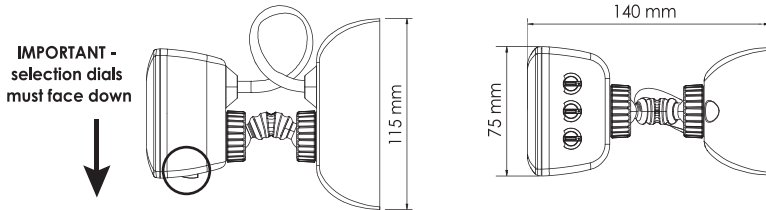

This product must be installed by a licensed electrician.

1. Switch off the mains power
2. Wire the sensor and the loads as per the wiring diagram
3. Mount the sensor onto the desired position
4. Switch on the mains power
5. Test the sensor working
6. Adjust the brightness threshold, sensitivity, and hold-time to suitable level

4.3 Wiring

The sensor is a 3-wire sensor that requires neutral wire, offering stable performance. Please wire as per the wiring diagram.

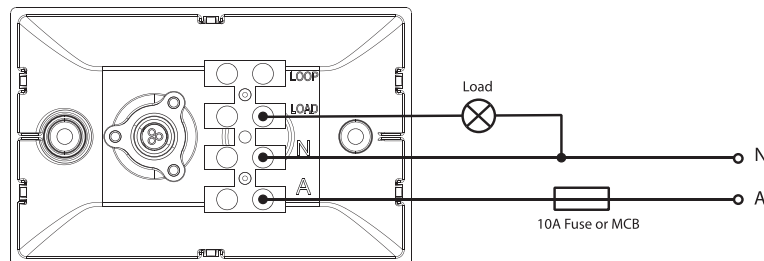

5. Operation and Function

5.1 LED indicator

- LED indicator is built in under the Fresnel lens, it lights up differently in response to different working status.
- There are three color LED indicators: white, blue, and green.
- LED indicator color is white when product is new or has been reset.
- LED indicator color can be blue or green after product is added to a network, depending on working status.
- The LED indicator can be turned off after the sensor being added to the App.

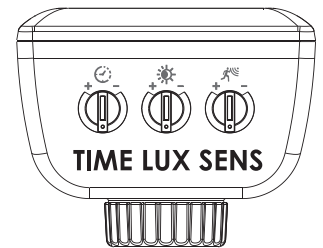

5.2 Key parameters: Hold-time, brightness threshold and Sensitivity

The sensor has three key parameters that need to be set according to the application requirements: Hold-time, brightness threshold and sensitivity. They can be adjusted on the dials under the sensor head: the dial with a clock icon is for hold-time, the dial with a sun icon is for brightness threshold, and the dial with a human icon is for sensitivity. They can also be adjusted in the App, after the sensor being added into the App.

Hold-time

The hold-time adjustment varies the time duration that the load will remain ON when it's activated by movement detections. The load will automatically be switched off when the hold-time period elapses if there is no new movements detected prior; should a new movement be detected before the hold-time elapses, the load will remain ON, another duration of hold-time will be added from the time of detection.

Rotate the dial anti-clockwise toward "+" to increase the hold-time, when the adjustment is fully anti-clockwise, the hold-time setting is 30 minutes. Rotate the dial clockwise toward "-" to decrease the hold-time setting, when the adjustment is fully clockwise, the hold-time setting is 10 seconds.

Brightness threshold

The brightness threshold adjustment makes the sensor to activate the load depending on the ambient brightness when there is movement detected in the detection range. The adjustment can be set to allow the sensor to activate the load all day (under full daylight) when movement is detected, or only to activate the load when the ambient brightness is below a certain level upon detection of movement. For example, the user can ensure the load is only activated when movement is detected at night time, while in the day time there is adequate natural daylight, the sensor does not respond to movements in the detection range to activate the load, as it is probably not necessary to do so for energy saving consideration.

Rotate the dial clockwise toward "+" to increase the brightness threshold, when the adjustment is fully clockwise and the arrow is pointing at the "+", the motion sensor will activate the load upon detection of movement all day regardless of ambient brightness. Rotate the dial anti-clockwise toward the "-" to decrease the brightness threshold, when the adjustment is fully anti-clockwise and the arrow is pointing at the "-", the motion sensor only activates the load upon detection of movement in the dark.

Sensitivity

The sensitivity adjustment changes the sensor detection range. The higher the sensitivity is, the movement from longer distance away can be detected.

Rotate the dial clockwise toward "+" to increase the sensitivity. Rotate the dial anti-clockwise toward the "-" to decrease the sensitivity.

5.3 Working modes

Four working modes are built in the sensor:

Motion sensor mode (or namely Auto mode): When the ambient brightness corresponds to brightness threshold setting, the sensor is monitoring infrared source movements in the detection field. The load is turned on when movement is detected, and the load is turned off when there is no more movement detected within hold-time

Override-On mode (or namely Always-On mode): The load is always kept ON regardless infrared movements in the detection range

Override-Off mode (or namely Always-Off mode): The load is always kept OFF regardless infrared movements in the detection range

Photocell mode (or namely PE sensor function): The load is always kept ON when the ambient brightness is lower than brightness threshold setting, and always kept OFF when the ambient brightness is higher than brightness threshold setting, regardless of infrared movements in the detection range

Before being added to the App, the sensor works in Motion sensor mode by default.

After being added into the App, the sensor can work in all 4 modes, see below for how to switch modes

	Option 1	Option 2	Option 3
How to switch to Override-On mode	Via the App, in the sensor control page	Via a paired PIXIE secondary device, double press the button	-
How to switch to Override-Off mode	Via the App, in the sensor control page	Via a paired PIXIE secondary device, triple press the button	-
How to switch to Photocell mode	Via the App, in the sensor control page	Via a paired PIXIE secondary device, six press the button	-
How to return to Motion sensor mode	Via the App, in the sensor control page	Via a paired PIXIE secondary device, single press the button	Switch off the power to the sensor, wait for 10 seconds, then resupply power to the sensor

5.4 Warm-up

When power is supplied to the sensor, the LED indicator of the sensor will flash slowly for 20-30 seconds. During this period, the load is kept at ON status regardless of motion or ambient brightness. This is warm-up process of the sensor, to get ready for the functionalities. When the LED indicator stops flashing, and the load is turned OFF, the warm-up process is finished. After warm-up, the sensor will always enter Motion sensor mode as default setting.

5.5 Function and LED indicator response

Motion sensor mode.

Scenario	Ambient bightness	Load response	LED Indicator	Remark
When movement is detected	Below the threshold	The load is turned on, and kept on during the hold-time	Flash once	If there is no new movement detected, the load will be turned off when hold-time elapse
When a new movement is detected within the duration of the last detection	Below the threshold	The load is kept on, the hold-time timer restarts from the new signal	Flash once	Hold-time is added continually
When movement is detected	Above the threshold	No response, stays at OFF	No response, stays at OFF	The sensor will not respond to infrared source movement when ambient brightness is higher than threshold setting
When there is no movement detected	NA	Stays at OFF	Stays at OFF	The sensor is on standby

Override-On mode, Override-Off mode and Photocell mode

Scenario	Load response	LED Indicator	Remark
Override-On mode	The load is kept on	Stays at green	The load is always on regardless of movement or ambient brightness
Override-Off mode	The load is kept off	Stays at blue	The load is always off regardless of movement or ambient brightness
Photocell mode	The load is off when the ambient brightness is higher than preset brightness threshold; The load is kept on when the ambient brightness is higher than preset brightness threshold	Keeps flashing every 5 seconds	-

Sensor detection range

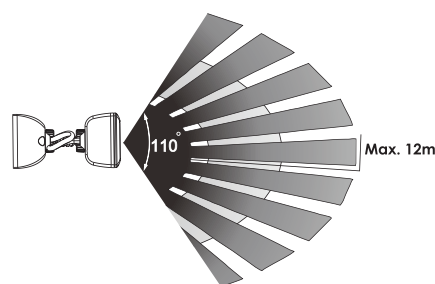
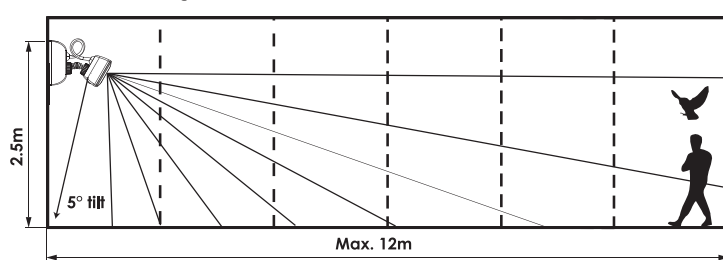

5.6 Work with PIXIE secondary devices

The sensor can pair and work with three PIXIE secondary devices***: SMF/BTAS, SMRM/BTAS, SMRP/BTAS

Note: Pairing operation is only available in the App. Please add the sensor into the App before commencing pairing operation.

Operation on a paired PIXIE secondary device and correspondent functions on the sensor

Single press: Switch the sensor to Motion sensor mode

Double press: Switch the sensor to Override-On mode

Triple press: Switch the sensor to Override-Off mode

Six press: Switch to Photocell mode

5.7 Test and configuration

Option 1-Test and configure in the App (Recommended)

1. Supply power to the sensor, after 30 seconds' warm-up, the sensor is ready to operate
2. Add the sensor into the SAL PIXIE or PIXIE PLUS App
3. Follow the step-by-step guide in the App to finalise the configuration of the sensor

Option 2-Test and configure manually

1. Turn the TIME dial to full clockwise to the minimum, which is 10 seconds set
2. Turn the LUX dial to full clockwise to the 'Sun' icon, which is the maximum (Note: When testing the sensor under daylight, please always turn LUX dial to the maximum position, otherwise the sensor will not operate)
3. Turn the SENS dial to full clockwise, which is maximum
4. Adjust the sensor head to desired direction
5. Supply power to the sensor, after 30 seconds' warm-up, the sensor is ready to operate
6. Walk slowly around the desired detection field, to confirm the load is activated upon movement from within the desired detection field
7. Set the brightness threshold to the desired level
8. Set the hold-time to the desired time for normal operation
9. Set the sensitivity to desired level
10. Adjust the sensor head direction if necessary

***The compatible PIXIE secondary device list is subject to change due to product evolution and availability.

6. Trouble shooting

The connected load does not operate

1. Check if the connected power source and load is correct
2. Check if the settings of connected load correspond to ambient light

The sensitivity is poor

1. Please check if there is any hindrance in front of the sensor to affect it to receive the infrared signals
2. Check if the ambient temperature is too high
3. Check if the infrared source is in the desired detection field
4. Check if the installation height corresponds to the height required in the instructions
5. Check if the infrared source moving direction is crossing the sensing pattern, or toward the sensor

The sensor does not turn off the connected load automatically

1. Check if there is continual infrared source moving in the detection field
2. Check if the hold-time is set to the maximum
3. Check if the sensor is set to work at Override-On mode
3. Check the wiring if the load is connected to constant power

7. How to download App

Scan QR code or go to App store (IOS) or Google Play

(Android) to download the free PIXIE app to your smart phone.
IOS: Requires IOS 6.0 or later. Compatible with iPhone, iPad and iPad touch

Android: Requires Android 4.4 or above, devices must support Bluetooth 4.0 Specifications above are for reference only and may vary without prior notice.



8. Warranty

In accordance with SAL's standard terms and conditions of sale, SAL warrant this product to be free from defects in materials and or workmanship for a period as stated below for goods not subject to incorrect installation, maintenance, operation, mishandling, environmental, unauthorised modifications or electrical operating conditions outside the nominated product specification as detailed in these installation instructions.

The benefits to you given by this warranty are in addition to other rights and remedies you have under law. Our goods come with guarantees that cannot be excluded under the Australian Consumer Law. You are entitled to a replacement or refund for a major failure and compensation for any other reasonably foreseeable loss or damage. You are also entitled to have the goods repaired or replaced if the goods fail to be of acceptable quality and the failure does not amount to a major failure.

Warranty term – Residential usage (12) months, Commercial usage (12) months

8.1 How to make a claim?

Step #1 – Within 30 days of the fault discovery, please contact the original place of the SAL product purchase during standard (local) business hours, with the following information (a) proof of purchase (b) description and quantity of the claimed fault (c) address of installation. (d) operating hours of the product.

Step #2 – It is then the responsibility of the original place of product purchase to report the matter to SAL aftersales;

NSW ACT	SAL National Pty Ltd, 40 Bilbela Street Villawood NSW 2163	P # 02 9723 3099
QLD	SAL National Pty Ltd, 36 Whitelaw Place Richlands QLD 4077	P # 07 3879 5999
VICT TAS SA NT	SAL National Pty Ltd, 46-48 Keys Road Moorabbin Victoria 3189	P # 03 9532 3168
WA	SAL National Pty Ltd, 29 Beringarra Av Malaga WA 6090	P # 08 9248 7458

Step #3 - Upon review of your claim and if the product is required to be returned to SAL for technical evaluation, then at the owners expense the product must be returned to SAL as per the above nominated locations.

Step #4 - Pending the evaluation, the claim will be validated resulting in the product being repaired or replaced with the same or best equivalent product at the discretion of SAL, or rejected if the product fault was found to be caused by conditions beyond the responsibility of SAL warranty obligations. Consideration of installation, product removal, return freight and or testing fees are not the responsibility of SAL.

9. Scan QR code to access the full product information

