

# CONNECT TO YOUR HOME WIFI AND PAIR WITH YOUR SMART ALLY FLOODLIGHT WITH CAMERA & SENSOR – 21891/06.

**BEFORE YOU BEGIN PLEASE DOWNLOAD AND REGISTER THE BRILLIANTSMART APP.**

**For help or assistance go to [www.brilliantsmart.com.au](http://www.brilliantsmart.com.au)**

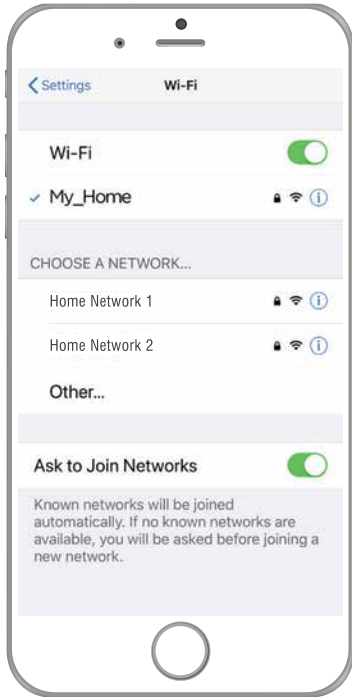

**Enable your WiF network on you mobile device making sure to select 2.4GHz frequency network if your home network supports dual band frequencies. i.e. 2.4GHz or 5GHz.**

**It's important that you connect to 2.4GHz Frequency. Please disable or unselect the 5GHz Frequency in home WiFi network if able. This can be reselected or enabled once the smart devices have been paired to the BrilliantSmart app.**

*Note: if you are not familiar with this procedure you may need to contact your internet service provider for some assistance.*

 Before installation of your BrilliantSmart device (in the location you desire) please check the WiFi signal is at least 2 bars strength on your mobile device WiFi icon.

If a poor WiFi signal, upgrading your router, installing an AP(Access Point) or adding a WiFi Extender may be needed (sold separately). If installing more than 15 smart devices to your WiFi Network, we do not recommend using WiFi extenders – these will be recognised from your Network as a separate Smart device and will limit your connectivity.

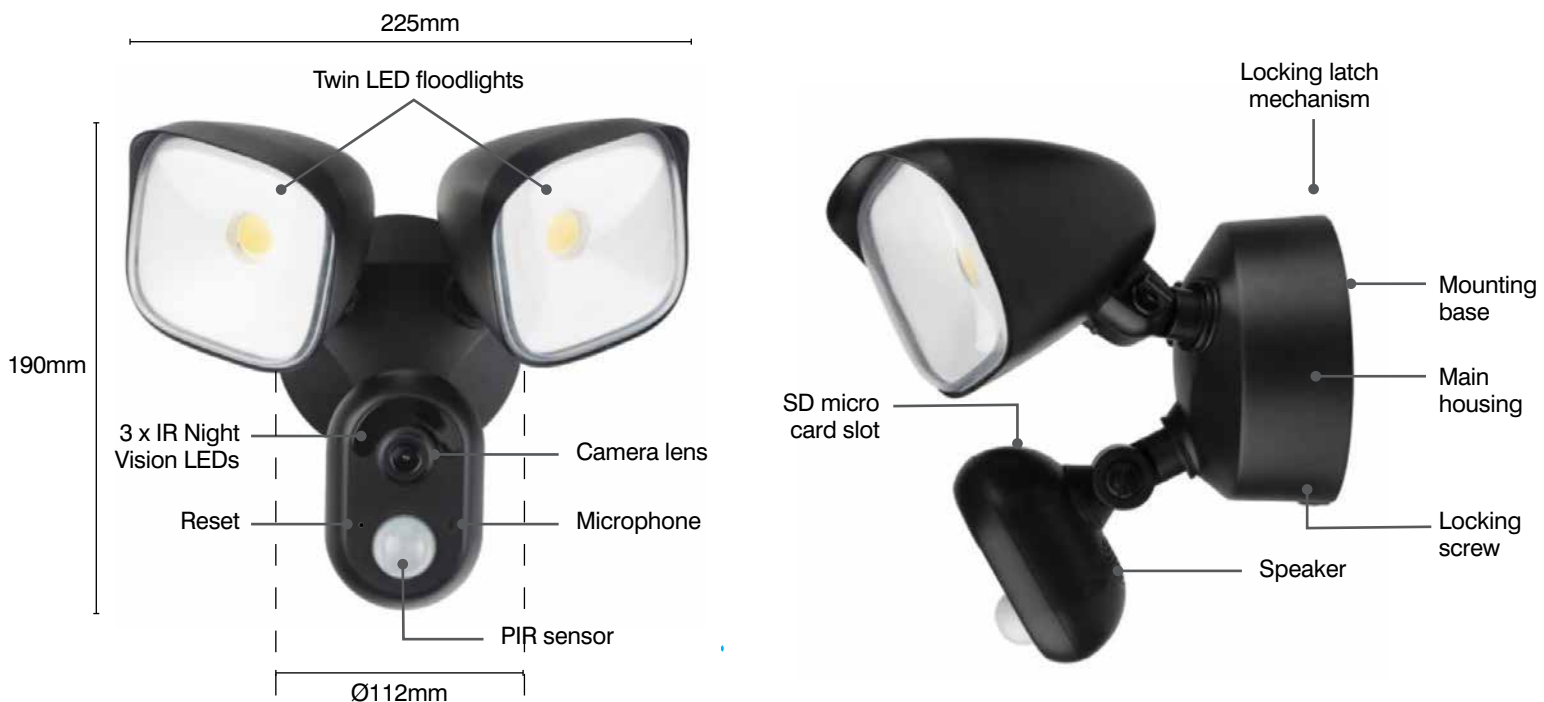

## TECHNICAL SPECIFICATIONS

<b>MODEL NO: 21891/05 – THIS PRODUCT HAS NO SERVICEABLE PARTS</b>			
Power Input:	220V–240V AC 50Hz	LED Lights:	20W – 2 x 10W Chip On Board (COB) Integrated LED
LED Colour Temp:	Cool white	Controls:	Via BrilliantSmart App Only
Construction:	ABS and PC Plastic UV Resistant, Aluminium Heatsink	Electrical Classification:	Class II
Camera:	FHD 1080 2.0 Megapixel camera	Day vision: Night vision IR:	Up to 15 meters distance max Up to 5 metres distance max
Memory/storage:	Micro SD card up to 128GB – Class 10 minimum (not included)	Motion detection:	3-Level motion detection (low, medium, high)
Audio:	High quality two-way audio	Motion sensor detection angle:	110° (sensor only)
Weather resistant rating:	IP44	Maximum sensor distance:	10m
Works with 2.4GHz WiFi frequency only		Security: Mac Encryption; WEP/WAPI/TKIP/AES	
WiFi Standard: 2.4GHz IEEE802.11b/g/n		System Req's: iOS 8.0 or higher, Android 4.1 or higher	
<b>Included in the box:</b> Smart Ally Floodlight with WiFi Camera, Mounting Screw x 2, Rawl Plugs x 2, Security Tool x 1, Installation Manual x 1			

## INSTALLATION

### DEVICE MUST BE INSTALLED BY A QUALIFIED ELECTRICAL CONTRACTOR.

**ATTENTION: THIS PRODUCT MUST BE INSTALLED WITH ITS OWN WALL MOUNTED ISOLATION (ON/OFF) SWITCH.**

#### FOR YOUR SAFETY

- To prevent electrical shock, please ensure that POWER is DISCONNECTED before installation.
- Do not install in a position where the fitting can be easily accessed by children or the infirm.
- Do not touch any parts of the wire terminal with bare hands while it is 'ON'.
- Do not perform modification to the unit.
- Any alterations or additions to building wiring must be completed by a licensed electrician or person authorised by legislation to work on the fixed wiring of any electrical installation.

#### WARNINGS

- Installation, repair and/or inspection must be conducted by qualified personnel in accordance with Australian Standards and local Building codes.
- Care must be taken to ensure electrical wiring and other hidden utilities are not damaged when drilling or cutting mounting surface.
- Do not operate this fitting in harsh environmental conditions such as building sites.
- Do not install it on surfaces which can move or vibrate.
- Do not allow children to play with wall switch turning ON/OFF rapidly.
- Ensure wire connections are firm.
- Do not attempt to perform modification or change parts within the unit.
- Please dispose of this packaging and product thoughtfully once it has passed its useful life. When your smart device comes to the end of its life or you choose to update or upgrade it, please do not dispose of it with your normal household waste. Please recycle where facilities exist. When disposing of this fitting, check with your local authority for suitable options.

#### PLEASE NOTE

- BrilliantSmart App screens may differ due to application updates & improvements.
- Please use the device as per instructions.
- To prevent injury DO NOT open or tamper with internals of this device.
- Power surge/power loss could possibly reset smart device. If this happens follow setup instructions.

## INSTALLATION (continued)

### LOCATION SELECTION:

- For best performance, floodlight should be mounted 1.8 to 2.5 metres above the selected area.
- The sensor detection area can vary depending on mounting height and location.
- Select a mounting position where detection will occur across the scanning area.

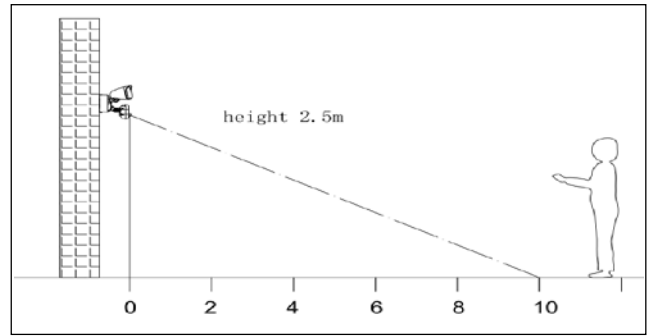

### DETECTION RANGE:

- The detection range of your sensor may alter with changes in temperature.
- DO NOT direct the sensor toward the sun.
- To avoid nuisance detections, your sensor light should be directed away from sources of heat such as barbecues, air conditioners, outside lighting, moving cars or flue vents.
- Consider your neighbour when positioning the unit.
- Unit is most sensitive to movement across sensor.

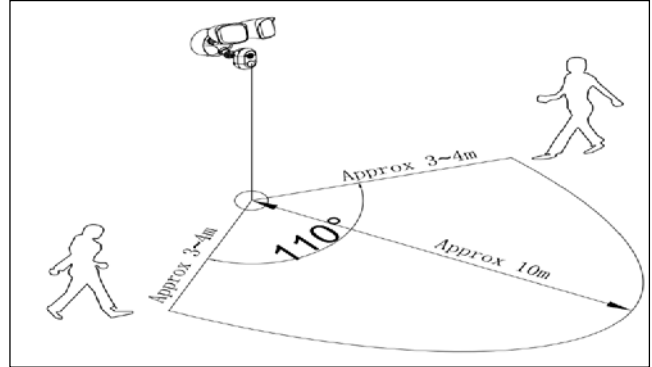

**BEFORE INSTALLATION, PLEASE CHECK THAT THE LOCATION SELECTED FOR THE INSTALLATION OF THE SMART DEVICE IS WITHIN RANGE OF YOUR HOME WIFI AND THE SIGNAL IS STRONG.**

### INSTALLATION OF MICRO SD CARD

Before mounting product to surface, using supplied security tool unscrew and remove MicroSD cover and insert MicroSD Card – 128Gb Max Class 10 (sold separately).

Once MicroSD card is correctly inserted, replace cover and secure firmly.

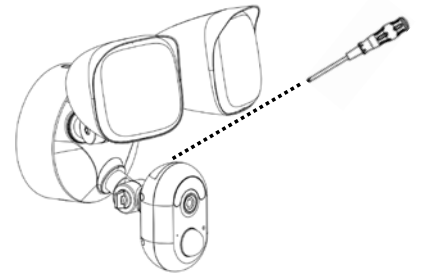

### STEP 1

Remove product from packaging. Dispose of packaging thoughtfully as to Local Government guidelines.

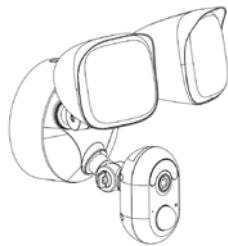

### STEP 2

Turn **OFF** mains power before installation of wiring and connecting device.

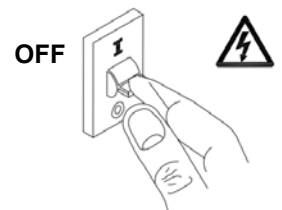

### STEP 3

Using Philips screw driver remove Locking Screw from base and set aside **(A)**.

Using your finger press down on Locking Latch Mechanism **(B)**.

Remove Mounting Base from Main Housing **(C)**.

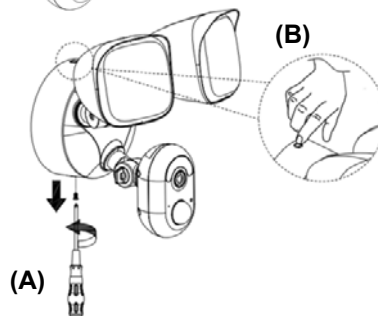

### STEP 4

Turn **OFF** mains power before installation of wiring and connecting device.

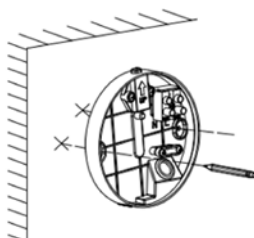

### STEP 5

Insert supplied Rawl Plugs **(A)**. Strip and pull electrical wiring through cable access hole **(B)**.

Secure mounting base to surface with Supplied Screws **(C)**.

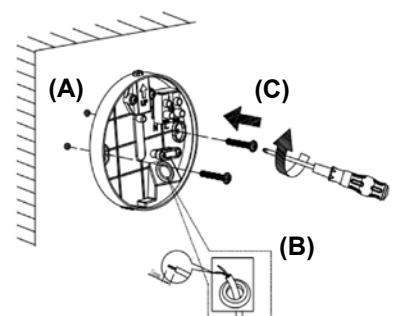

## INSTALLATION (continued)

### STEP 6

Remove cable anchor **(A)**. Connect wires Active **(L)** and Neutral **(N)** according to the markings on the terminal block **(B)**. Push any excess cable through cable entry hole **(C)** and secure firmly with cable anchor **(A)**.

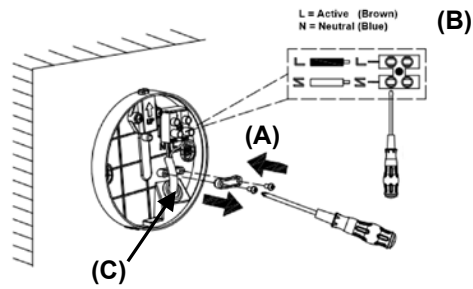

### STEP 7

Carefully line up main housing connection contacts with terminal block contacts on mounting base.

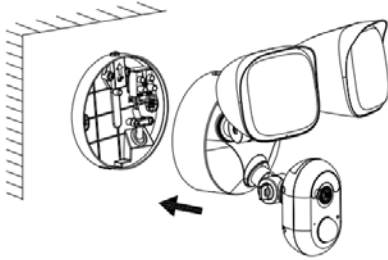

### STEP 8

Push main housing onto mounting base making sure locking latch mechanism clicks in place on main housing **(A)**. Return locking screw in base **(B)**.

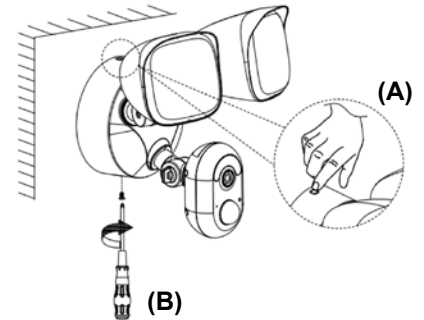

### STEP 9

Once fully installed and secured onto surface place a bead of silicon (colour of your choice) 360° around base and surface. This is required to maintain IP rating and warranty.

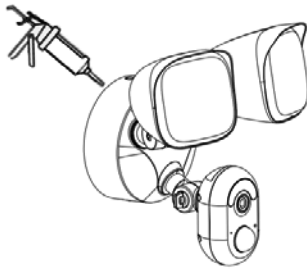

### STEP 10

Return mains power to **ON**.

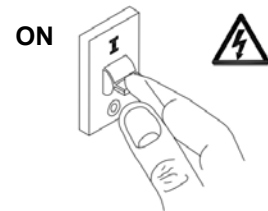

## BRILLIANTSMART APP – ALLY floodlight with WiFi camera – START UP

On power-on the floodlights turn on, camera chimes and the Sensor LED RED will light up. After approx 40 seconds the sensor LED turns RED will begin to blink slowly, then the floodlights will turn off/on after another 10 seconds.

1. Open the BrilliantSmart App that you've previously registered and setup.
2. Press the home screen. If you are connecting a smart device for the first time – press 'Add Device' or if you are adding another smart device – press the plus sign '+'.  
*Icons may differ depending on your phone, tablet or operating system.*
3. Next select the type of device you wish to add. If you're connecting a Smart device with a camera, tap 'Smart Camera'.  
*Icons may differ depending on your phone, tablet or operating system.*
4. If you have heard a chime or a prompt tone then tap on the 'tick' for 'make sure the indicator is flashing quickly or a prompt tone is heard'. Then press 'Next'.
5. Select your 2.4GHz network on your home modem and enter your password. *Note: for first time users you may need to search for your 2.4GHz network and add your password. Once your device is paired, the BrilliantSmart app will save this information so you don't need to re-enter each time a device is added. This is private and confidential with no access from third parties.*
6. Scan the QR code with the smart camera. Ensure the QR code is facing the smart camera lens approx 20cm apart – hold until the smart camera chimes. Select 'I Heard a Prompt'.
7. The BrilliantSmart app will start connection to your smart device. The sensor LED BLUE will stop flashing once connection is in progress.
8. Once connected you'll get a 'tick' and message to show your device has successfully connected. Select the room your device is to be located. Select the pen icon to change the name of your smart device.
9. Type in the new device name and press 'Save'.

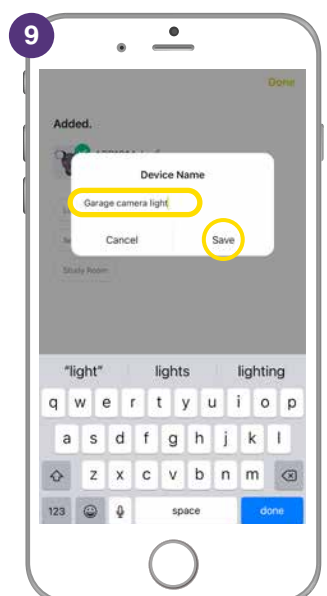
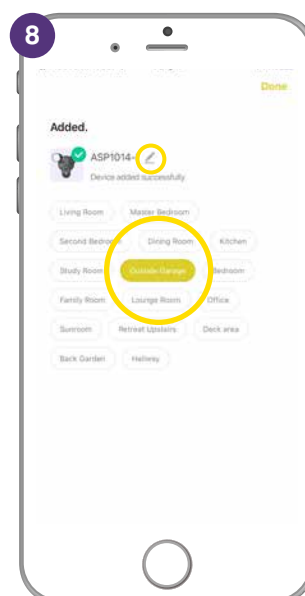
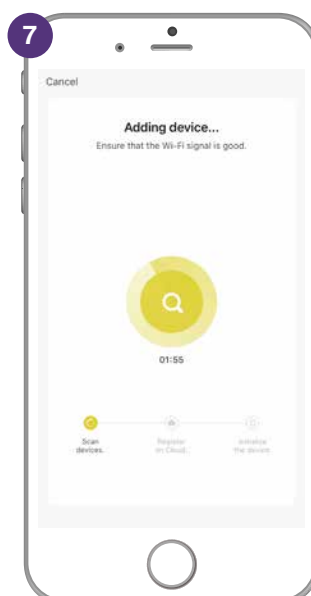
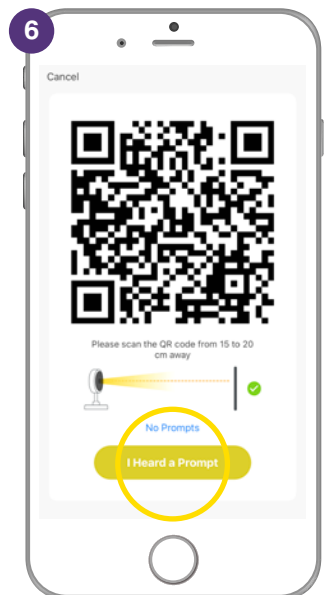
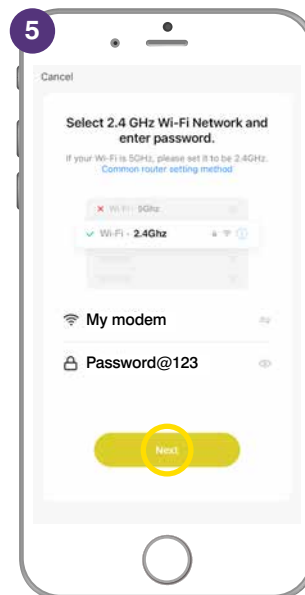
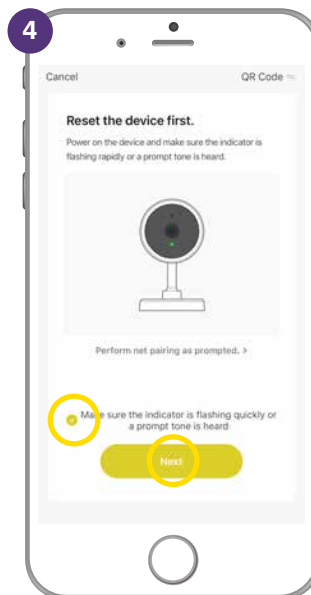
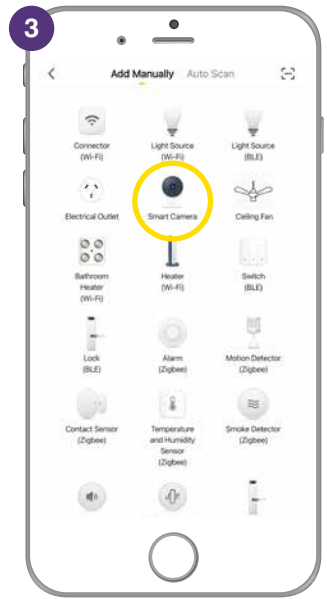
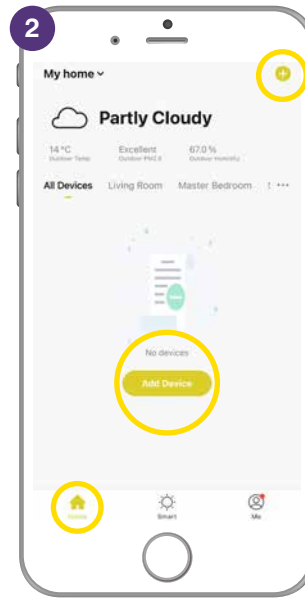
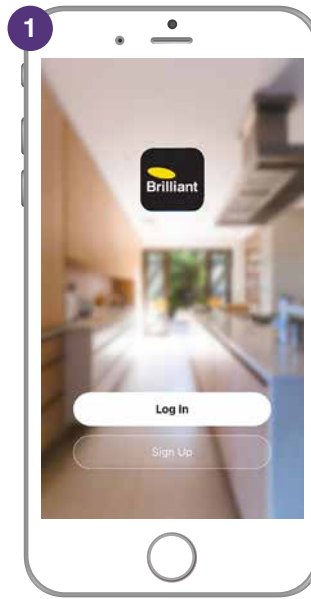

## BRILLIANTSMART APP – ALLY floodlight with WiFi camera – START UP (continued)

10. The smart device can now be controlled by the BrilliantSmart app.

11. Select your **Camera floodlight** to select or change settings.

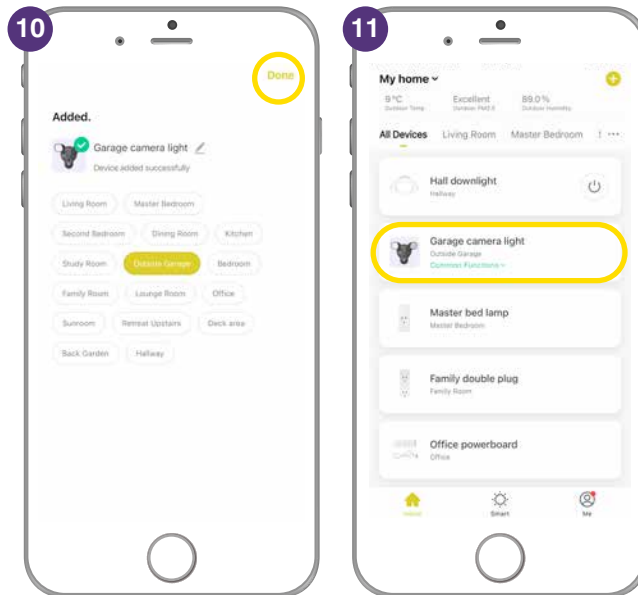

## RESET DEVICE

**RESET DEVICE** – If the device fails to go into pairing mode after the initial start up. Using the supplied Reset Pin, press and hold reset switch for 5 seconds. Device will chime and floodlights will flash times. Wait 40–50 seconds for device to initialise with Red LED blinking and proceed with Step 1 of WiFi Setup.

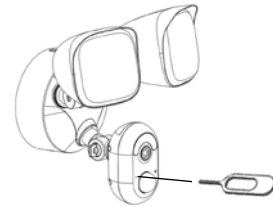

## FULL FACTORY RESET

If the smart device is non responsive in the app, the device may need to be reset to factory settings.

1. Open BrilliantSmart App.
2. Select and hold down on device Icon.
3. Check select device then Select Remove Device.
4. Select Confirm to **'Delete device or dismiss group?'**.
5. Select **'Done'**.
6. Device is now deleted from the BrilliantSmart app and Cloud. Follow Wifi Setup page 5 to reconnect device to BrilliantSmart app.

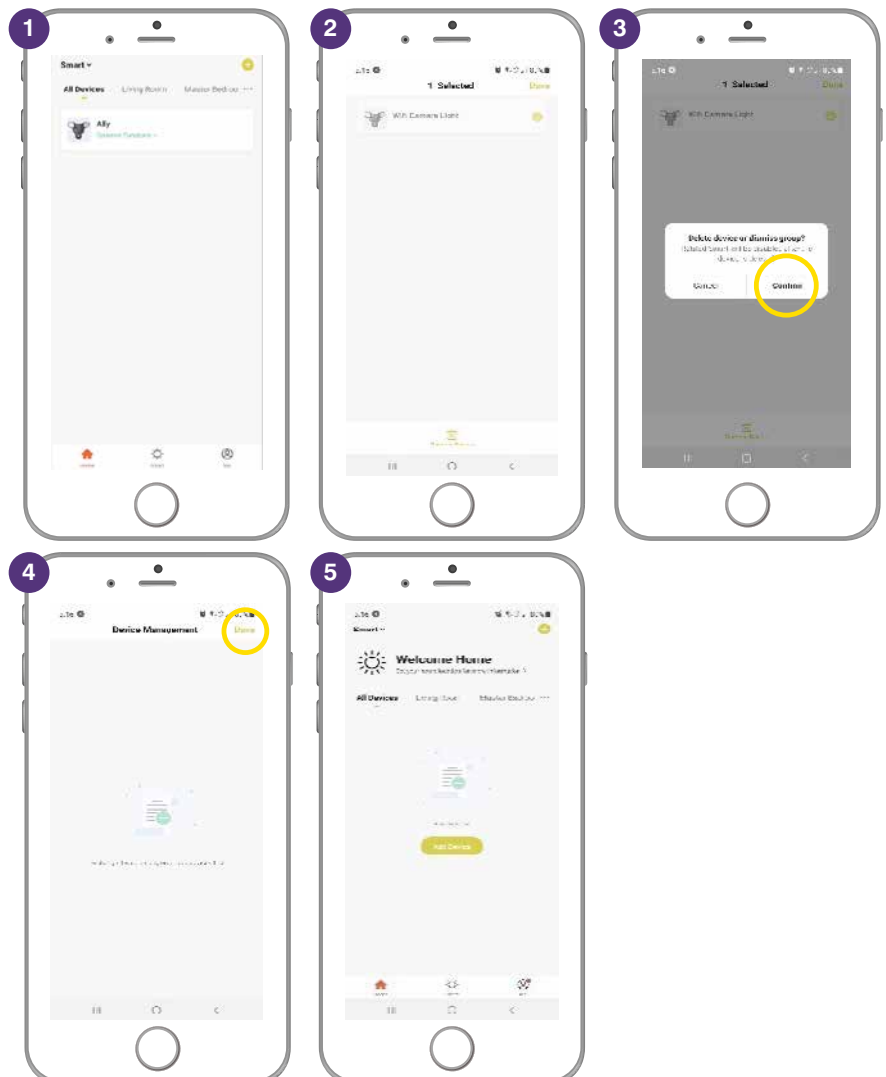

# BRILLIANTSMART APP – SETTINGS

1. Select the Floodlight that you've renamed.
2. **Sound/Speaker**  
 – 🔊 press to turn sound ON  
 – 🔇 press to turn OFF.
3. **HD or SD** – press to change from HD (high definition) or SD (standard definition) photo quality.
4. **Full screen** – press to have your image the full screen width & height.
5. Tap on the screen and the **arrow** appears – press to return to previous screen.
6. Select the **'pen icon'** to for more settings.
7. Select '**Basic Function Settings**'.
8. **Status Indicator** – ON/OFF to show that camera is on and monitoring.
9. **Flip Screen** – flips the camera image 180°.
10. **Time Watermark** – puts the date and time stamp on the camera image.
11. Press the arrow to return to previous screen.

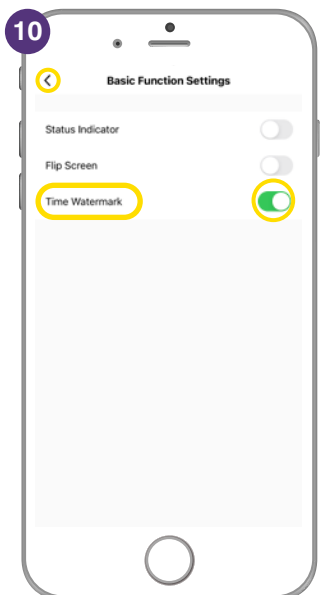
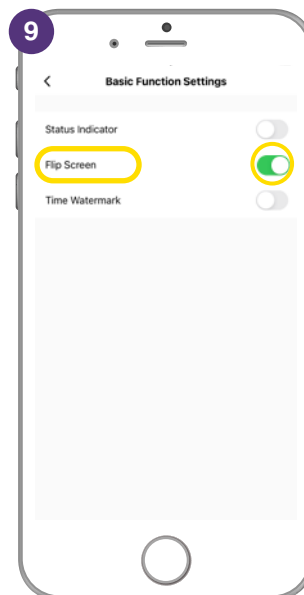
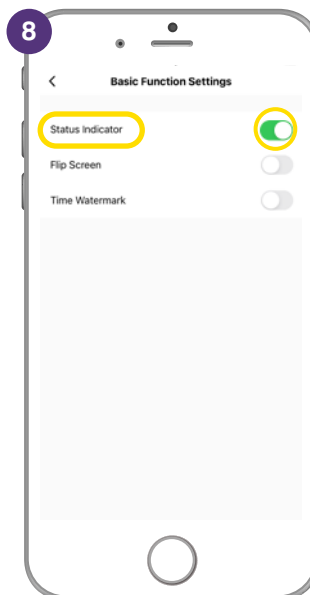
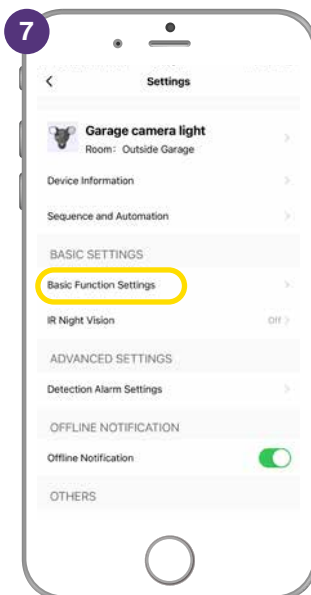
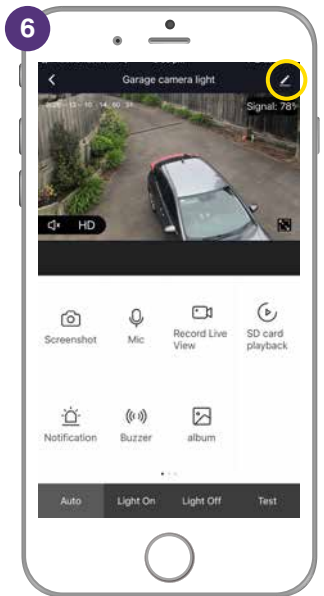
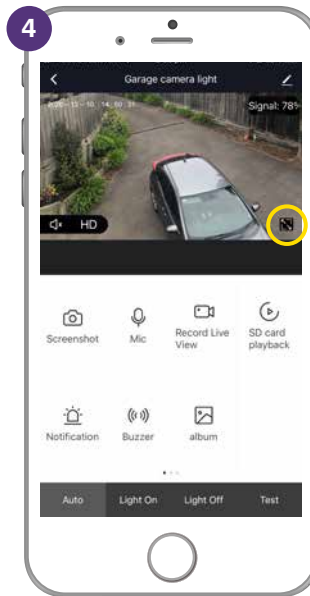
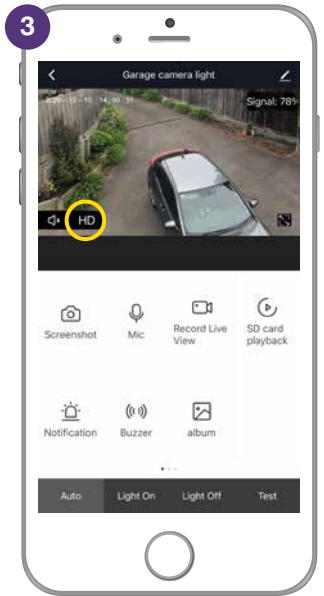
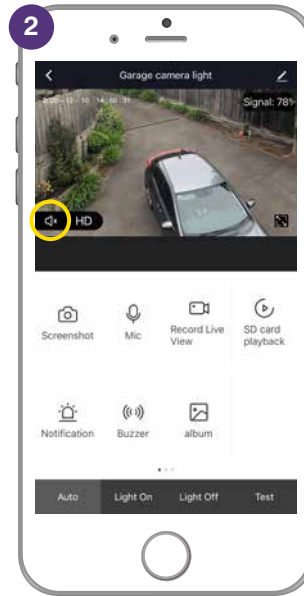
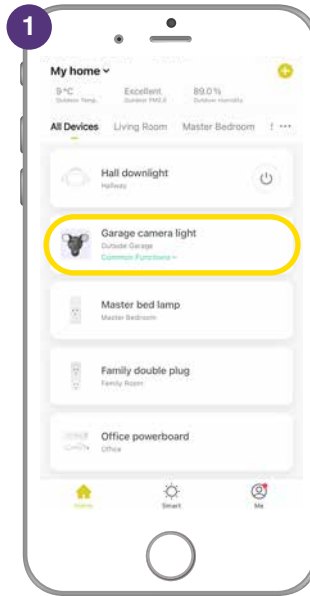

## BRILLIANTSMART APP – SETTINGS 1

1. **Screenshot** – on the BrilliantSmart App, select to take a HD 1080 screenshot. If it's night, then the super bright floodlights illuminate the area so you can identify visitors, cars, intruders and more at any time of the day.
2. The App saves the screenshot to your phone photo gallery.
3. **Mic** – select if you want to talk to visitors or scare intruders – gives you two-way conversation.
4. **Record Live View** – select to take a video of visitors, intruders or more.
5. The App saves the video to your phone photo album.
6. **SD card playback** – only works if you have a SD memory card installed. Camera automatically records to the SD memory card if movement is detected.
7. **Notification** – select to turn on the Motion Detection Alarm. The alarm on the Ally Floodlight will sound if motion is detected.
8. Slide to the right to turn on the Motion Detection Alarm

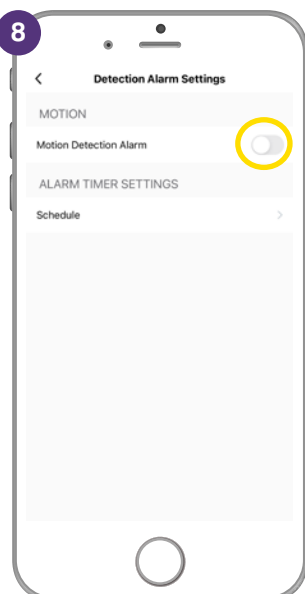
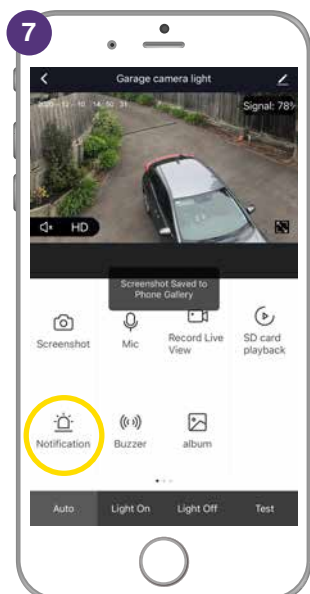
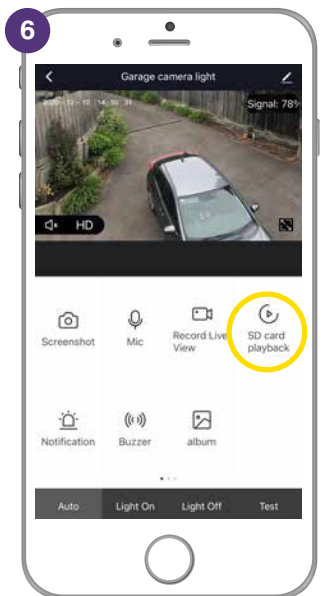
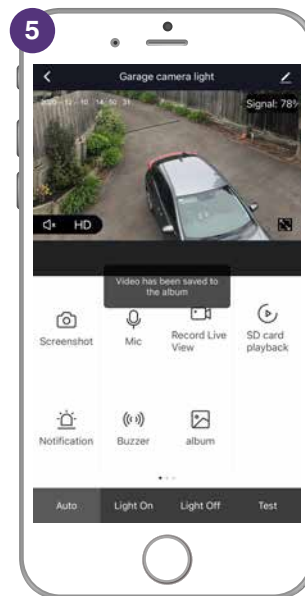
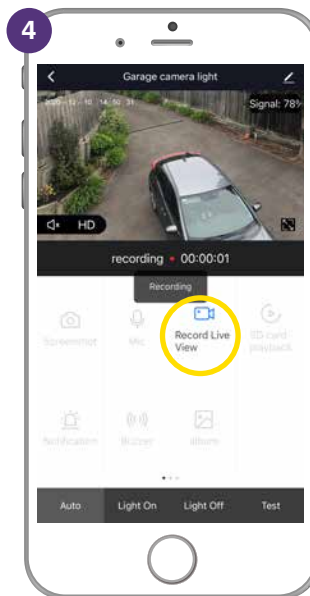
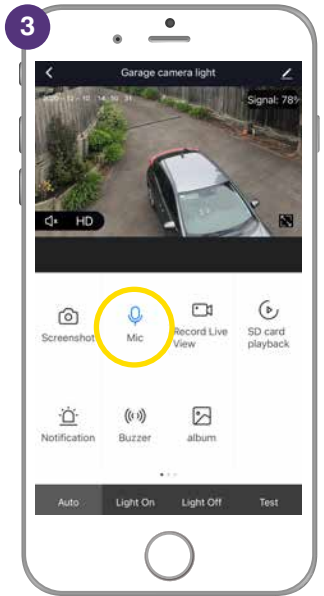
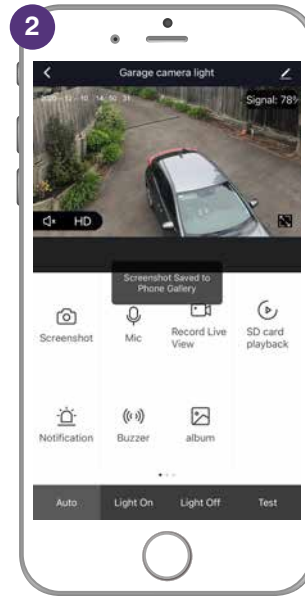
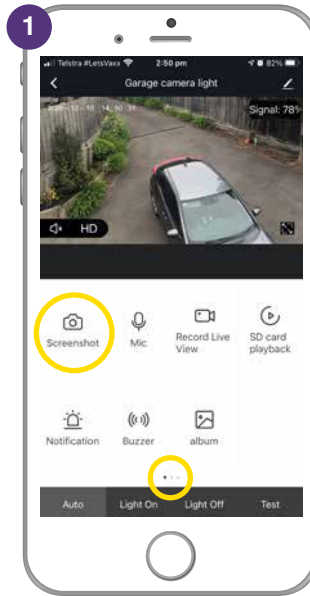



## BRILLIANTSMART APP – SETTINGS 1 (CONTINUED)

9. Select 'Alarm Sensitivity Level'.

10. Change the motion sensitivity to **Low**, **Medium** or **High**.

Press the **arrow** to return to previous screen.

11. **Schedule** – select to turn the motion alarm on only at certain times of the day – eg: could be when you are not at home or at certain times of the night.

12. Press 'Add' to add schedules.

13. Select the time required.

14. Select the days required. (If no days are selected then it will turn on or off only once.) Press arrow to return to the previous screen.

15. Slide to turn on 'Notification' – App sends a message to your phone.

16. Select Motion Detection to turn it on or off.

17. Select ON or OFF. Press **arrow** to return to previous menu.

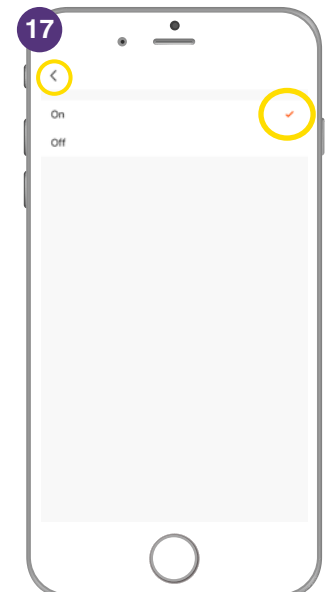
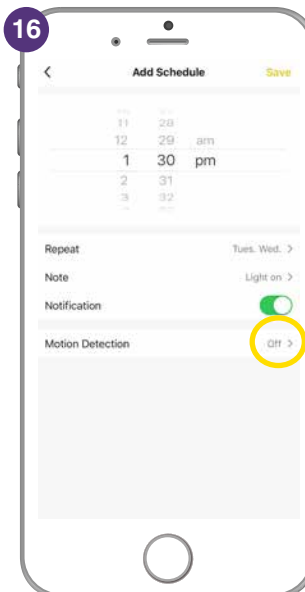
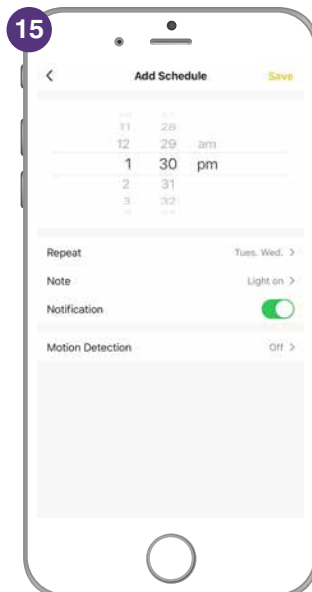
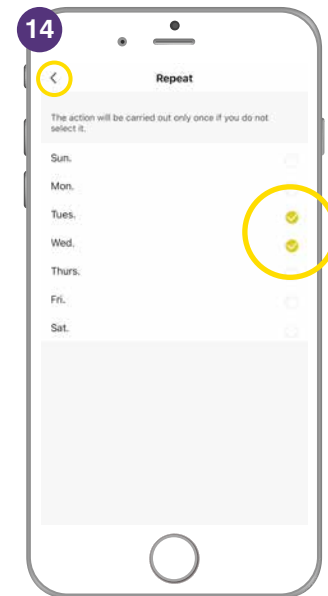
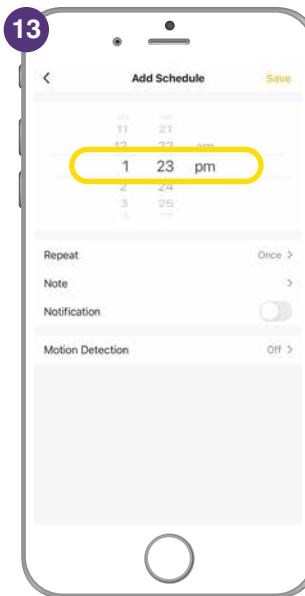
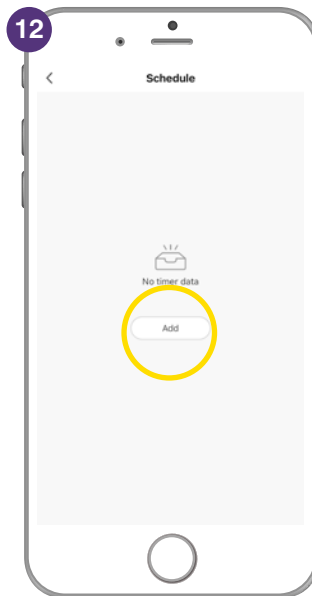
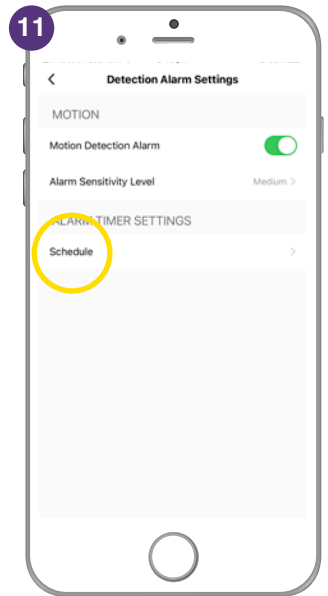
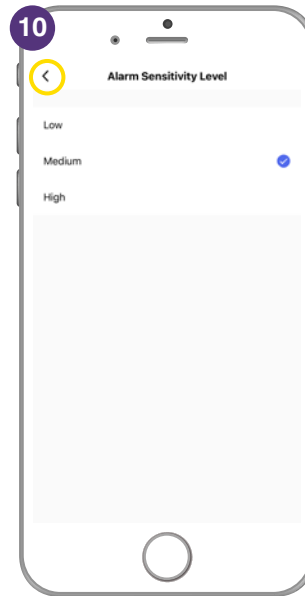
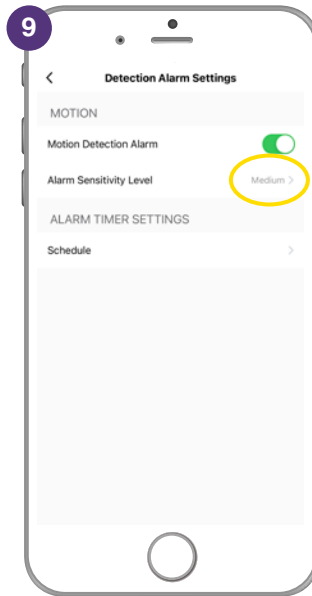

## BRILLIANTSMART APP – SETTINGS 1 (CONTINUED)

18. Press 'Save' to save your settings.

19. To set a schedule to turn OFF the Motion Detection – select 'Add Schedule' and repeat the steps above.

20. Once you've completed your schedule – press the **arrow** to return to previous menu.

21. **Buzzer** – you can turn the Buzzer on the Ally Floodlight ON at any time to sound an alarm to attract attention or to scare an intruder.

22. Select the buzzer icon to turn ON – alarm will sound.

23. Select the buzzer icon to turn OFF the alarm. Press the arrow to return to previous menu.

24. **Album** – select to view any screenshots or videos you have manually saved to your phone.

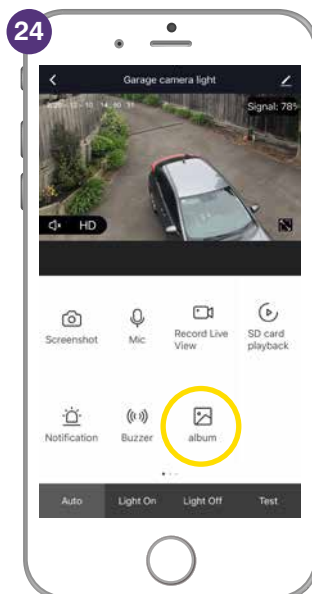
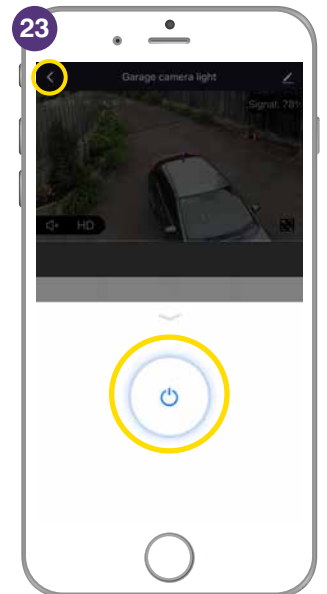
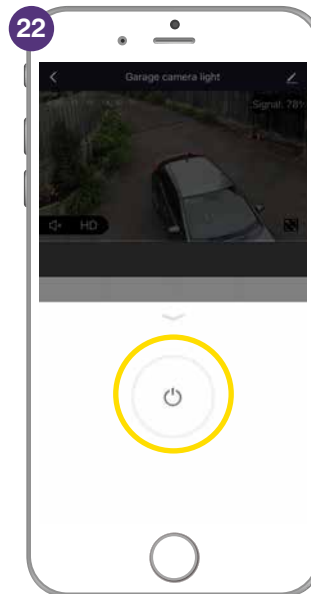
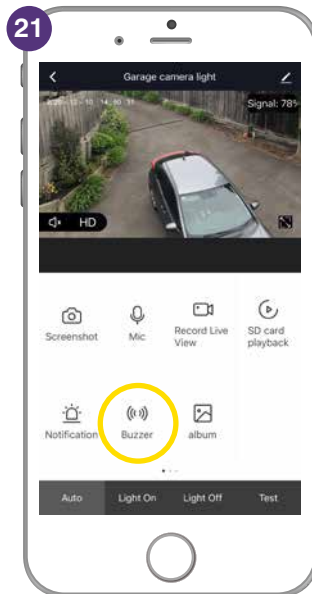
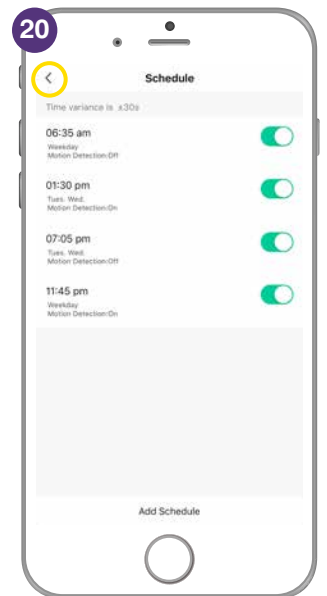
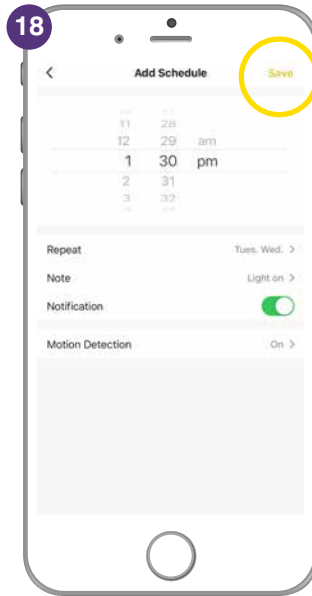

## BRILLIANTSMART APP – SETTINGS 2

Swipe the bottom of the screen left to access next set of settings.

- Manual Override** – to turn your Ally Floodlights on – for 3 hours, 6 hours or D2D (dusk to dawn).
- Press gently to change the ON time 3h, 6h or D2D.
- Sensor Sensitivity** – select to change to **L** (low) **M** (medium) or **H** (high).
- Press gently to change the sensor sensitivity. Press **arrow** to return to previous menu.
- Auto** – automatically uses the settings to turn the floodlights on or off.

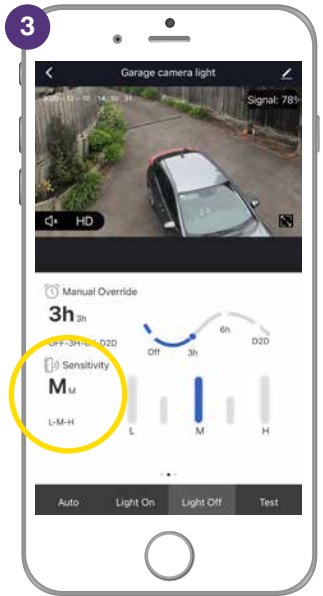
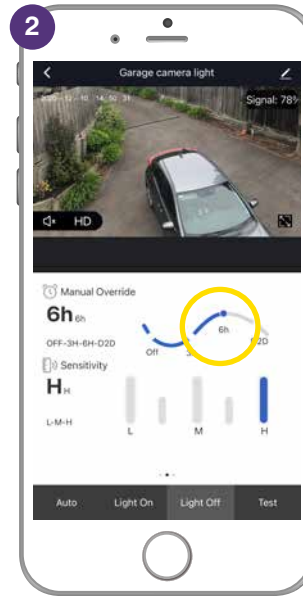
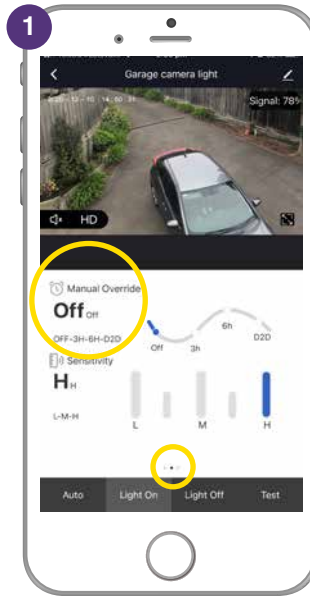

- Light On** – turns the floodlights ON.
- Light Off** – turns the floodlights OFF.
- Test** – allows you to test the settings. Press **arrow** to return to previous menu.

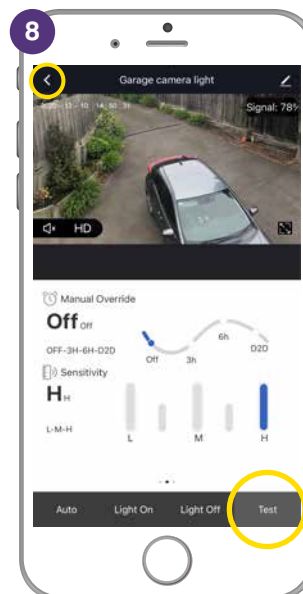
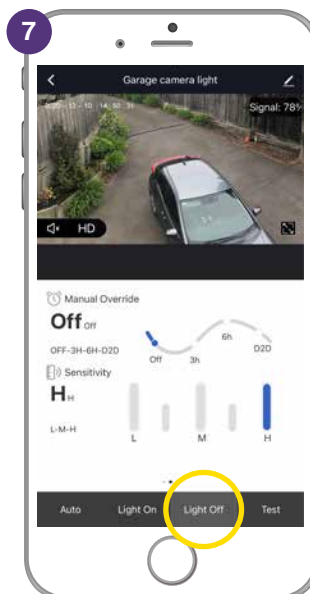
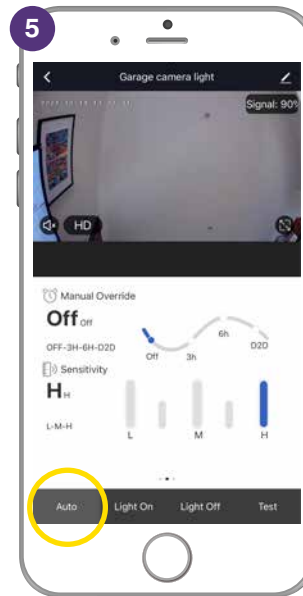
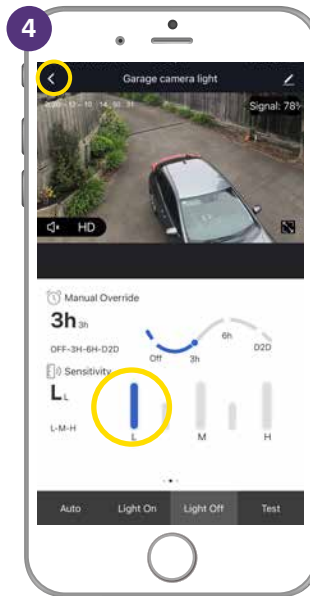

## BRILLIANTSMART APP – SETTINGS 3

Swipe the bottom of the screen left to access next set of settings.

1. **Brightness** – select to change the strength or brightness of the light emitted in all directions from the Ally Floodlights.
2. Slide left to right from 0 to 100% – the higher the percentage the brighter the light.
3. **Duration** – select to change the duration the Ally Floodlights stay ON.
4. Slide left to right from 0 to 10 minutes.
5. **LUX** – select to change the light intensity that is cast onto an object from the Ally Floodlights.
6. Slide left to right from 0 to 200 – the higher the percentage the more intense the light.
7. **Colour Temp** – Not available for the Ally Floodlight at this time. Press the **arrow** to return to previous menu.

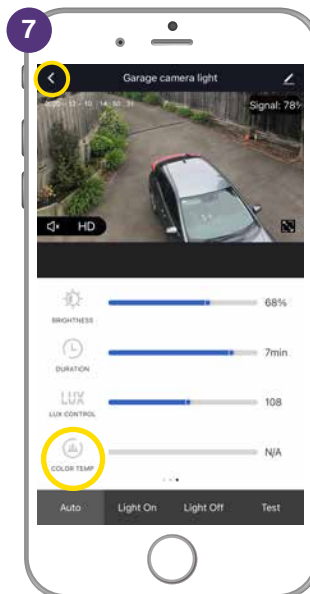
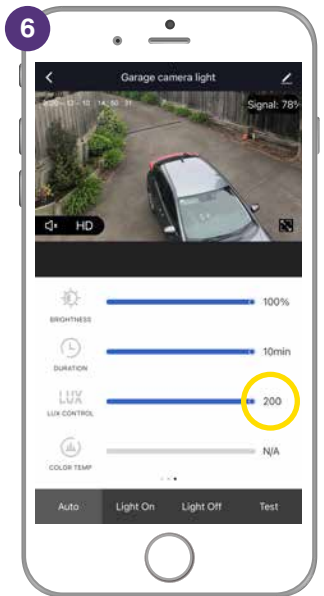
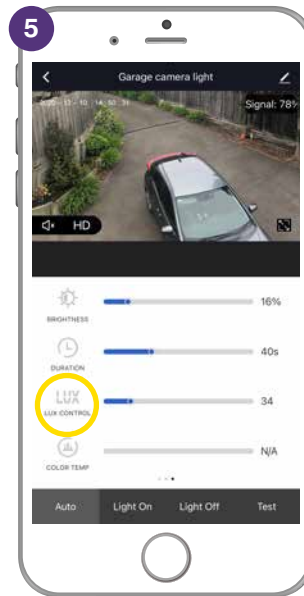
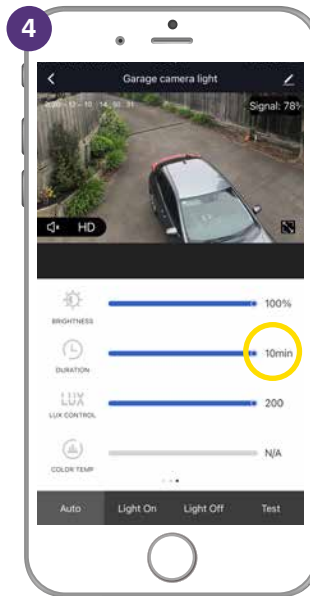
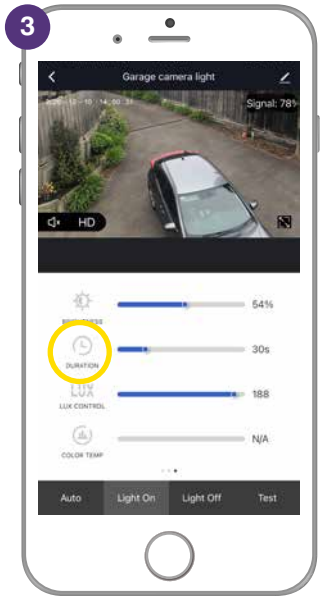
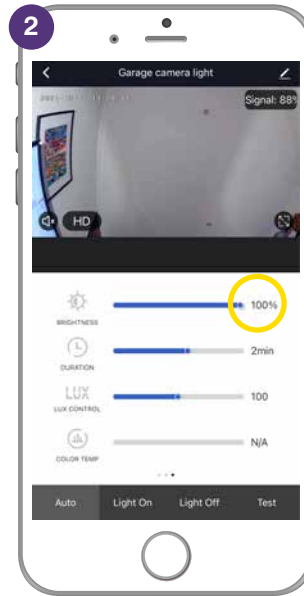
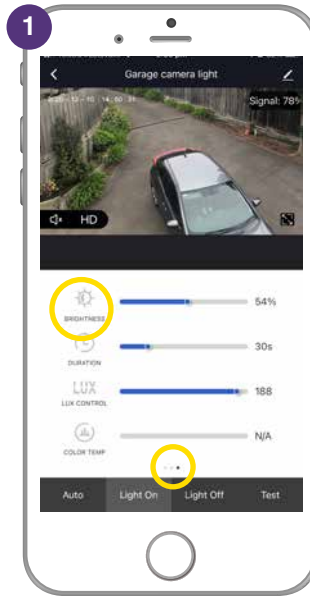

## TROUBLESHOOTING

### Problem:

LED indicator light not on or device not powering up.

Possible Cause	Suggested Solution
A. Fuse or circuit breaker has blown.	A. Check main and branch circuit breakers.
B. Loose wire connections to the unit.	B. Check all wire connections to the unit are secure & firmly attached and/or plugs are firmly into the power socket.

### Problem:

Indicator light is flashing or device is offline.

Possible Cause	Suggested Solution
A. Device lost internet connection and unable to go back online.	A. Restart device.

### Problem:

Unable to pair the device with the BrilliantSmart app.

Possible Cause	Suggested Solution
A. Device not in pairing mode.	A. Press and hold reset switch for 10 seconds until device LED. indicator turns red and starts blinking. (Supplied reset pin may need to be used for models with internal reset switch).
B. No Internet access.	B. Ensure WiFi network is working and able to access internet connection. Refresh the WiFi modem by switching the power OFF then ON. If problem still persists, please contact your internet service provider.
C. Dual WiFi network modem.	C. Ensure your mobile device are connected to 2.4GHz network before start the pair process. Disable 5GHz temporarily until pairing is completed.
D. Modem is too far away from the unit.	D. May need to use WiFi extender or AP for strong WiFi signal in range.
E. BrilliantSmart App requires update.	E. Check & install latest smart app update from the App store.
F. BrilliantSmart App not responding.	F. Remove/delete the app from the mobile device then re-install the smart app.
G. WiFi bandwidth not enough. Too many devices connected to the WiFi modem.	G. Standard modem usually allows connection of up to 10–15 devices. If too many devices are connected, we advise to upgrade the modem or use a WiFi MESH gateway/device.

### Problem:

Device in the BrilliantSmart app shown Offline.

Possible Cause	Suggested Solution
A. No Internet access.	A. Ensure WiFi network is working and able to access internet connection.
B. Requires refresh to the BrilliantSmart app.	B. At home screen, pull down the screen to refresh the app. Or close the app and start again in your mobile device.
C. Smart device power turns on less than 1 minute.	C. When smart device power on it will take up to 1 to 2 minutes to connect to the cloud server. Wait at least 1 to 2 minutes and refresh the home screen.

For any other problems connecting your smart device to BrilliantSmart app please visit: [www.brilliantsmart.com.au/faqs](http://www.brilliantsmart.com.au/faqs)