

Mr. SLIM

# Air Conditioners

Indoor unit

## SLZ-M25, M35, M50, M60FA-A

**OPERATION MANUAL**

For safe and correct use, please read this operation manual thoroughly before operating the air-conditioner unit.

FOR USER

English

# Contents





1. Safety Precautions .....	2	6. Emergency Operation for Wireless Remote-controller .....	16
2. Parts Names .....	3	7. Trouble Shooting .....	16
3. Operation .....	6	8. Installation, relocation and inspection.....	17
4. Timer.....	14	9. Specifications .....	18
5. Care and Cleaning.....	15		

**Note:**  
The phrase “Wired remote controller” in this operation manual refers only to the PAR-40MAA. If you need any information for the other remote controller, please refer to the instruction book included in this box.

## 1. Safety Precautions

- ▶ Before installing the unit, make sure you read all the “Safety Precautions”.
- ▶ The “Safety Precautions” provide very important points regarding safety. Make sure you follow them.
- ▶ Please report to or take consent by the supply authority before connection to the system.

### MEANINGS OF SYMBOLS DISPLAYED ON THE UNIT

	<b>WARNING</b> (Risk of fire)	This mark is for R32 refrigerant only. Refrigerant type is written on nameplate of outdoor unit. In case that refrigerant type is R32, this unit uses a flammable refrigerant. If refrigerant leaks and comes in contact with fire or heating part, it will create harmful gas and there is risk of fire.
		Read the OPERATION MANUAL carefully before operation.
		Service personnel are required to carefully read the OPERATION MANUAL and INSTALLATION MANUAL before operation.
		Further information is available in the OPERATION MANUAL, INSTALLATION MANUAL, and the like.

### Symbols used in the text

- ⚠ **Warning:**  
Describes precautions that should be observed to prevent danger of injury or death to the user.
- ⚠ **Caution:**  
Describes precautions that should be observed to prevent damage to the unit.

### Symbols used in the illustrations

- ⚡ : Indicates a part which must be grounded.

- ⚠ **Warning:**
  - There appliances are not accessible to the general public.
  - The unit must not be installed by the user. Ask the dealer or an authorized company to install the unit. If the unit is installed improperly, water leakage, electric shock or fire may result.
  - Do not alter the unit. It may cause fire, electric shock, injury or water leakage.
  - Do not stand on, or place any items on the unit.
  - Do not splash water over the unit and do not touch the unit with wet hands. An electric shock may result.
  - Do not spray combustible gas close to the unit. Fire may result.
  - Do not place a gas heater or any other open-flame appliance where it will be exposed to the air discharged from the unit. Incomplete combustion may result.
  - Do not remove the front panel or the fan guard from the outdoor unit when it is running.
  - When you notice exceptionally abnormal noise or vibration, stop operation, turn off the power switch, and contact your dealer.
  - Never insert fingers, sticks etc. into the intakes or outlets.
  - If you detect odd smells, stop using the unit, turn off the power switch and consult your dealer. Otherwise, a breakdown, electric shock or fire may result.
  - This air conditioner is NOT intended for use by children or infirm persons without supervision.
  - Young children must be supervised to ensure that they do not play with the air conditioner.
  - If the refrigeration gas blows out or leaks, stop the operation of the air conditioner, thoroughly ventilate the room, and contact your dealer.
  - This appliance is intended to be used by expert or trained users in shops, in light industry and on farms, or for commercial use by lay persons.

- This appliance can be used by children aged from 8 years and above and persons with reduced physical, sensory or mental capabilities or lack of experience and knowledge if they have been given supervision or instruction concerning use of the appliance in a safe way and understand the hazards involved. Children shall not play with the appliance. Cleaning and user maintenance shall not be made by children without supervision.
- This appliance is not intended for use by persons (including children) with reduced physical, sensory or mental capabilities, or lack of experience and knowledge, unless they have been given supervision or instruction concerning use of the appliance by a person responsible for their safety.
- Children should be supervised to ensure that they do not play with the appliances.
- When installing or relocating, or servicing the air conditioner, use only the specified refrigerant written on outdoor unit to charge the refrigerant lines. Do not mix it with any other refrigerant and do not allow air to remain in the lines.  
If air is mixed with the refrigerant, then it can be the cause of abnormal high pressure in the refrigerant line, and may result in an explosion and other hazards.  
The use of any refrigerant other than that specified for the system will cause mechanical failure or system malfunction or unit breakdown. In the worst case, this could lead to a serious impediment to securing product safety.
- This unit should be installed in rooms which exceed the floor space specified in outdoor unit installation manual.  
Refer to outdoor unit installation manual.

# 1. Safety Precautions

- Do not use means to accelerate the defrosting process or to clean, other than those recommended by the manufacturer.
- The appliance shall be stored in a room without continuously operating ignition sources (for example: open flames, an operating gas appliance or an operating electric heater).

- Do not pierce or burn.
- Be aware that refrigerants may not contain an odour.

**⚠ Caution:**

- Do not use any sharp object to push the buttons, as this may damage the remote controller.
- Never block or cover the indoor or outdoor unit's intakes or outlets.

## Disposing of the unit

When you need to dispose of the unit, consult your dealer.

# 2. Parts Names

### Indoor Unit

	SLZ-M-FA-A
Fan steps	3 steps
Vane	Auto with swing
Louver	-
Filter	Long-life
Filter cleaning indication	2,500 hr
Wireless remote controller (PAR-SL97A-E) model No. setting	002

### SLZ-M-FA-A

4-way Ceiling Cassette

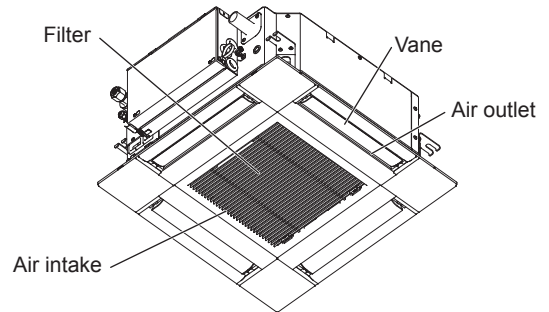

### Wired Remote Controller

#### Controller interface

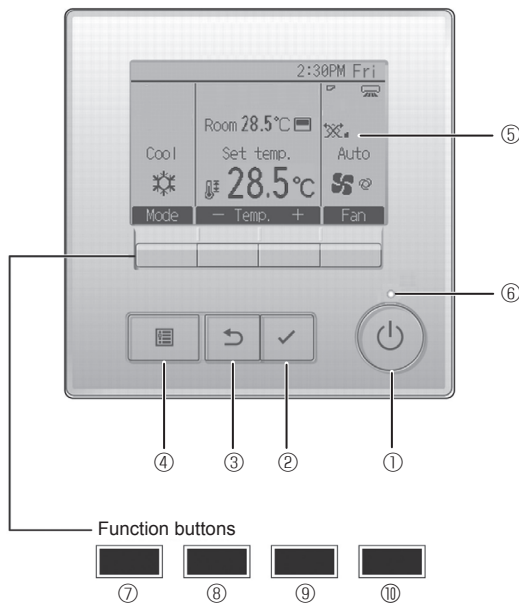

The functions of the function buttons change depending on the screen.

Refer to the button function guide that appears at the bottom of the LCD for the functions they serve on a given screen.

When the system is centrally controlled, the button function guide that corresponds to the locked button will not appear.

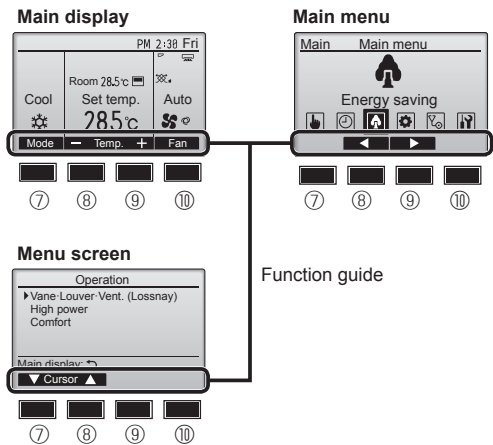

#### ① [ON/OFF] button

Press to turn ON/OFF the indoor unit.

#### ② [SELECT] button

Press to save the setting.

#### ③ [RETURN] button

Press to return to the previous screen.

#### ④ [MENU] button

Press to bring up the Main menu.

#### ⑤ Backlit LCD

Operation settings will appear.

When the backlight is off, pressing any button turns the backlight on and it will stay lit for a certain period of time depending on the screen.

When the backlight is off, pressing any button turns the backlight on and does not perform its function. (except for the [ON/OFF] button)

#### ⑥ ON/OFF lamp

This lamp lights up in green while the unit is in operation. It blinks while the remote controller is starting up or when there is an error.

#### ⑦ Function button [F1]

Main display: Press to change the operation mode.

Menu screen: The button function varies with the screen.

#### ⑧ Function button [F2]

Main display: Press to decrease temperature.

Main menu: Press to move the cursor left.

Menu screen: The button function varies with the screen.

#### ⑨ Function button [F3]

Main display: Press to increase temperature.

Main menu: Press to move the cursor right.

Menu screen: The button function varies with the screen.

#### ⑩ Function button [F4]

Main display: Press to change the fan speed.

Menu screen: The button function varies with the screen.

## 2. Parts Names

### Display

The main display can be displayed in two different modes: "Full" and "Basic". The factory setting is "Full". To switch to the "Basic" mode, change the setting on the Main display setting. (Refer to operation manual included with remote controller.)

<Full mode>

\* All icons are displayed for explanation.

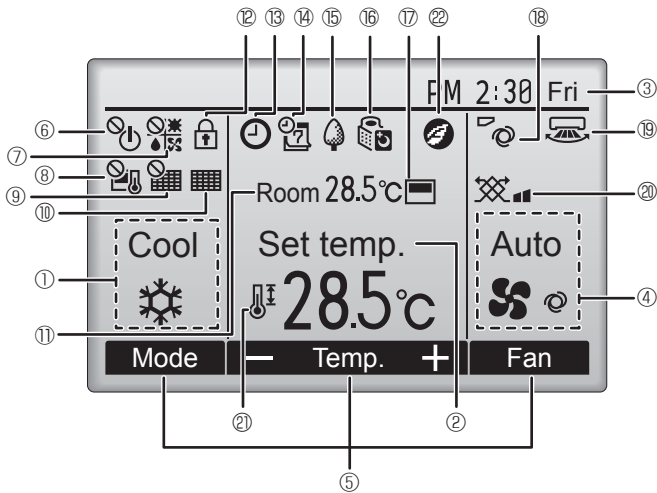

<Basic mode>

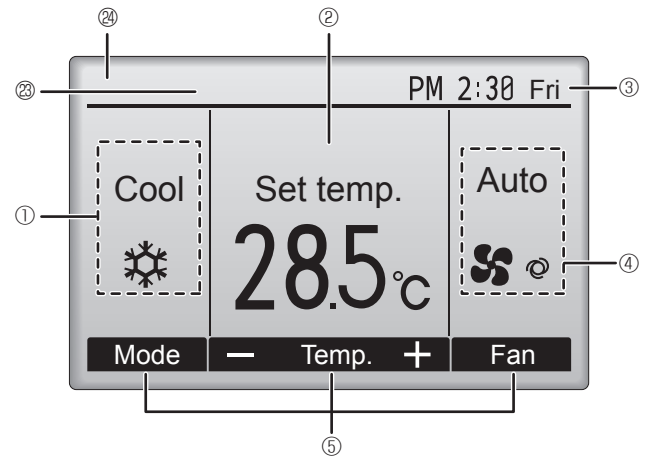

#### ① Operation mode

#### ② Preset temperature

#### ③ Clock

#### ④ Fan speed

#### ⑤ Button function guide

Functions of the corresponding buttons appear here.



Appears when the ON/OFF operation is centrally controlled.



Appears when the operation mode is centrally controlled.



Appears when the preset temperature is centrally controlled.



Appears when the filter reset function is centrally controlled.



Indicates when filter needs maintenance.

#### ⑪ Room temperature



Appears when the buttons are locked.



Appears when the On/Off timer, Night setback, or Auto-off timer function is enabled.

appears when the timer is disabled by the centralized control system.



Appears when the Weekly timer is enabled.



Appears while the units are operated in the energy-save mode. (Will not appear on some models of indoor units)



Appears while the outdoor units are operated in the silent mode.



Appears when the built-in thermistor on the remote controller is activated to monitor the room temperature (⑪).

appears when the thermistor on the indoor unit is activated to monitor the room temperature.



Indicates the vane setting.



Indicates the louver setting.



Indicates the ventilation setting.



Appears when the preset temperature range is restricted.



Appears when an energy-saving operation is performed using a "3D i-See sensor" function.

#### ⑳ Centrally controlled

Appears for a certain period of time when a centrally-controlled item is operated.

#### ㉑ Preliminary error display

An error code appears during the preliminary error.

Most settings (except ON/OFF, mode, fan speed, temperature) can be made from the Main menu.

## 2. Parts Names

### ■ Wireless Remote-Controller

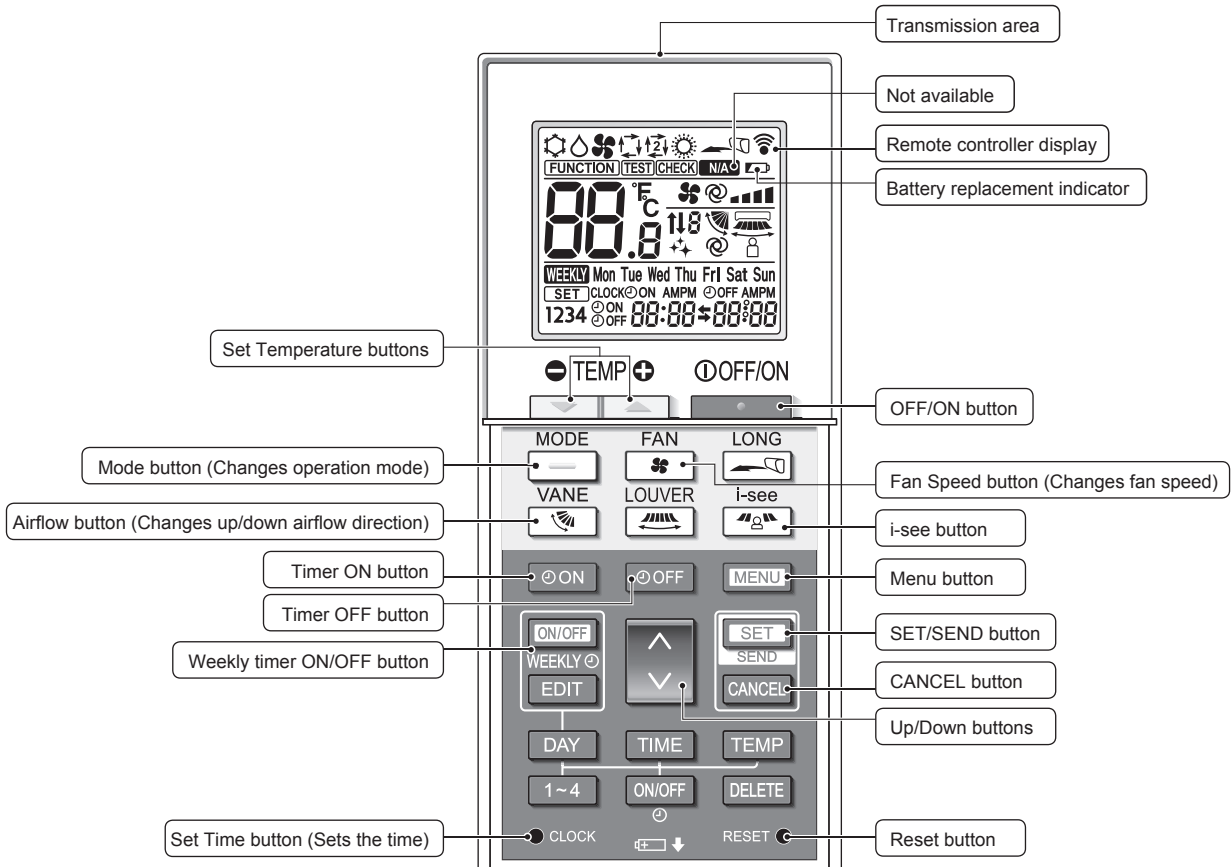

#### Operation mode

- Cool    Dry
- Fan    Auto (single set point)
- Heat    Auto\* (dual set point)

\* The initial setting is necessary. Refer to Installation manual.

#### Temperature setting

The units of temperature can be changed. For details, refer to the Installation Manual.

#### Vane setting

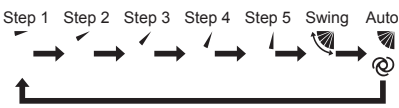

#### Not available

Appears when a non-supported function is selected.

#### Battery replacement indicator

Appears when the remaining battery power is low.

#### Fan speed setting



#### 3D i-see sensor (Air distribution)

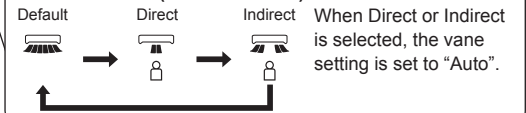

## 2. Parts Names

### Notes (Only for wireless remote controller):

- When using the wireless remote controller, point it towards the receiver on the indoor unit.
- If the remote controller is operated within approximately 2 minutes after power is supplied to the indoor unit, the indoor unit may beep twice as the unit is performing the initial automatic check.
- The indoor unit beeps to confirm that the signal transmitted from the remote controller has been received. Signals can be received up to approximately 7 meters in a direct line from the indoor unit in an area 45° to the left and right of the unit. However, illumination such as fluorescent lights and strong light can affect the ability of the indoor unit to receive signals.
- If the operation lamp near the receiver on the indoor unit is blinking, the unit needs to be inspected. Consult your dealer for service.
- Handle the remote controller carefully! Do not drop the remote controller or subject it to strong shocks. In addition, do not get the remote controller wet or leave it in a location with high humidity.
- To avoid misplacing the remote controller, install the holder included with the remote controller on a wall and be sure to always place the remote controller in the holder after use.
- If the indoor unit beeps 4 times when you are using the wireless remote controller, switch the auto mode setting to the AUTO (single set point) mode or AUTO (dual set point) mode. For details, refer to the included Notice (A5 sheet) or the Installation Manual.

### Outdoor unit

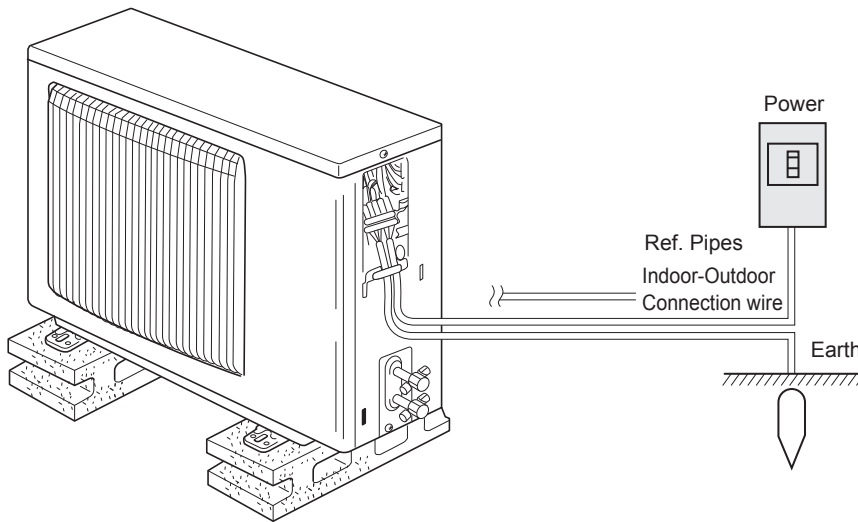

### Battery installation/replacement

1. Remove the top cover, insert two LR6 AA batteries, and then install the top cover.

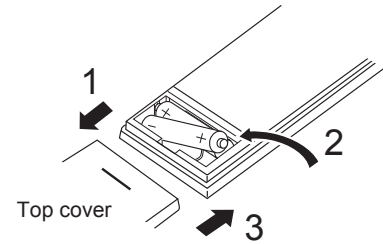

Two LR6 AA batteries  
Insert the negative (-) end of each battery first. Install the batteries in the correct directions (+, -)!

2. Press the Reset button.

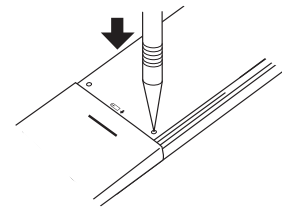

Press the Reset button with an object that has a narrow end.

After battery installation/replacement, please set clock.  
Without setting clock, you cannot use a part of function of remote controller.

## 3. Operation

- About the operation method, refer to the operation manual that comes with each remote controller.

### 3.1. Turning ON/OFF

[ON]



Press the [ON/OFF] button.  
The ON/OFF lamp will light up in green, and the operation will start.  
When "LED lighting" is set to "No," the ON/OFF lamp will not light up.

[OFF]



Press the [ON/OFF] button again.  
The ON/OFF lamp will come off, and the operation will stop.

#### Note:

Even if you press the ON/OFF button immediately after shutting down the operation is progress, the air conditioner will not start for about 3 minutes.

This is to prevent the internal components from being damaged.

### 3. Operation

#### ■ Operation status memory

	Remote controller setting
Operation mode	Operation mode before the power was turned off
Preset temperature	Preset temperature before the power was turned off
Fan speed	Fan speed before the power was turned off

#### ■ Settable preset temperature range

Operation mode	Preset temperature range
Cool/Dry	19 – 30 °C
Heat	17 – 28 °C
Auto	19 – 28 °C
Fan/Ventilation	Not settable

### 3.2. Mode Selection

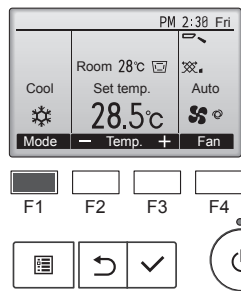

Press the [F1] button to go through the operation modes in the order of “Cool”, “Dry”, “Fan”, “Auto”, and “Heat”. Select the desired operation mode.

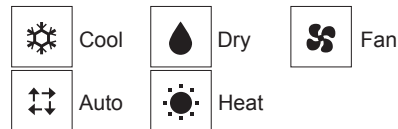

• Operation modes that are not available to the connected indoor unit models will not appear on the display.

#### What the blinking mode icon means

The mode icon will blink when other indoor units in the same refrigerant system (connected to the same outdoor unit) are already operated in a different mode. In this case, the rest of the unit in the same group can only be operated in the same mode.

#### Information for multi system air conditioner (Outdoor unit: MXZ series)

► Multi system air conditioner (Outdoor unit: MXZ series) can connect two or more indoor units with one outdoor unit. According to the capacity, 2 or more units can operate simultaneously.

- When you try to operate 2 or more indoor units with 1 outdoor unit simultaneously, one for the cooling and the other for heating, the operation mode of the indoor unit that operates earlier is selected. The other indoor units that will start the operation later cannot operate, indicating an operation state in blinking. In this case, please set all the indoor units to the same operation mode.
- There might be a case that the indoor unit, which is operating in “Auto” mode. Cannot change over to the operating mode “Cool”/“Heat” and becomes a state of standby.
- When indoor unit starts the operation while the defrosting of outdoor unit is being done, it takes a few minutes (max. about 15 minutes) to blow out the warm air.
- In the heating operation, though indoor unit that does not operate may get warm or the sound of refrigerant flowing may be heard, they are not malfunction. The reason is that the refrigerant continuously flows into it.

#### Automatic operation

- According to a set temperature, cooling operation starts if the room temperature is too hot and heating operation starts if the room temperature is too cold.

- During automatic operation, if the room temperature changes and remains 2 °C or more above the set temperature for 15 minutes, the air conditioner switches to cooling mode. In the same way, if the room temperature remains 2 °C or more below the set temperature for 15 minutes, the air conditioner switches to heating mode.

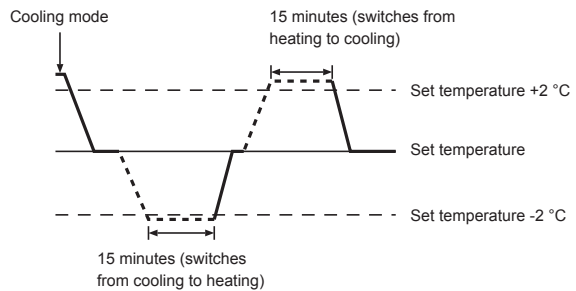

### 3.3. Temperature setting <Cool, Dry, Heat, and Auto>

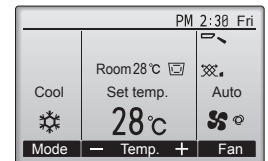
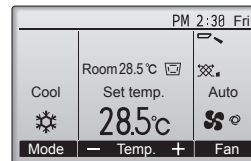

Example display (Centigrade in 1-degree increments)

Press the [F2] button to decrease the preset temperature, and press the [F3] button to increase.

- Refer to the table on 3-1 for the settable temperature range for different operation modes.
- Preset temperature range cannot be set for Fan/Ventilation operation.
- Preset temperature will be displayed either in Centigrade in 0.5- or 1-degree increments, or in Fahrenheit, depending on the indoor unit model and the display mode setting on the remote controller.



### 3. Operation

#### 3.4. Fan speed setting

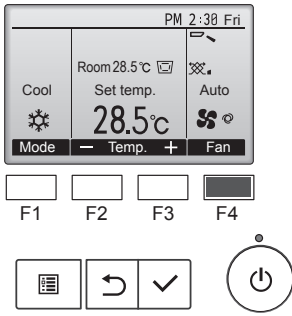

Press the [F4] button to go through the fan speeds in the following order.

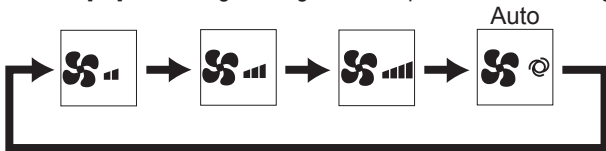

- The available fan speeds depend on the models of connected indoor units.

**Notes:**

- The number of available fan speeds depends on the type of unit connected.
- In the following cases, the actual fan speed generated by the unit will differ from the speed shown the remote controller display.
  1. While the display is in "STAND BY" or "DEFROST" states.
  2. When the temperature of the heat exchanger is low in the heating mode. (e.g. immediately after heating operation starts)
  3. In HEAT mode, when room temperature is higher than the temperature setting.
  4. In COOL mode, when room temperature is lower than the temperature setting.
  5. When the unit is in DRY mode.

#### 3.5. Airflow direction setting

##### 3.5.1 Navigating through the Main menu

###### <Accessing the Main menu>



Press the [MENU] button on the Main display. The Main menu will appear.

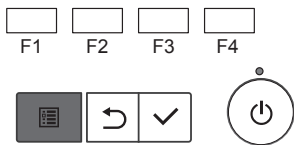

###### <Item selection>

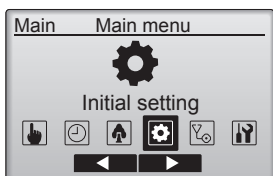

Press [F2] to move the cursor left. Press [F3] to move the cursor right.

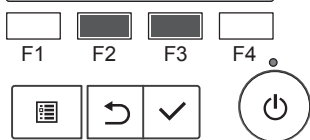

###### <Exiting the Main menu screen>

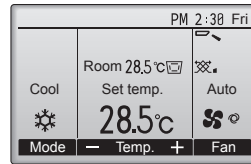

Press the [RETURN] button to exit the Main menu and return to the Main display.

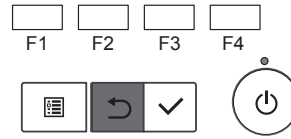

If no buttons are touched for 10 minutes, the screen will automatically return to the Main display. Any settings that have not been saved will be lost.

###### <Display of unsupported functions>

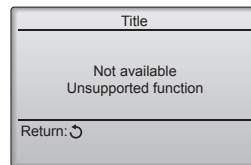

The message at left will appear if the user selects a function not supported by the corresponding indoor unit model.

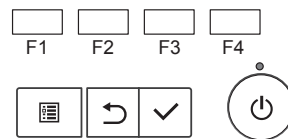



### 3. Operation

#### 3.5.2 Vane-Vent. (Lossnay)

<Accessing the menu>

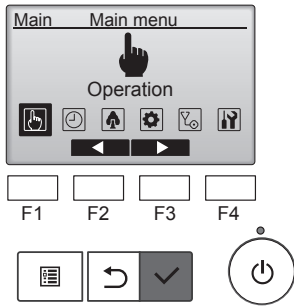

Select "Operation" from the Main menu (refer to 3.5.1), and press the [SELECT] button.

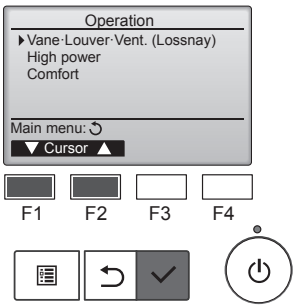

Select "Vane-Louver-Vent. (Lossnay)" from the Operation menu, and press the [SELECT] button.

<Vane setting>

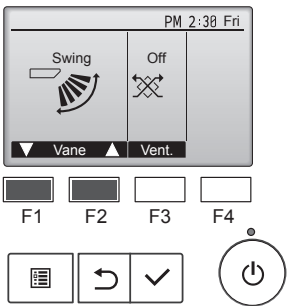

Press the [F1] or [F2] button to go through the vane setting options: "Auto", "Step 1", "Step 2", "Step 3", "Step 4", "Step 5", and "Swing." Select the desired setting.

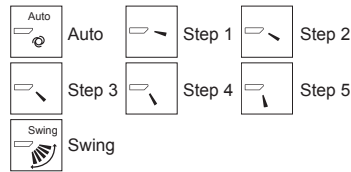

Select "Swing" to move the vanes up and down automatically. When set to "Step 1" through "Step 5", the vane will be fixed at the selected angle.

<Vent. setting>

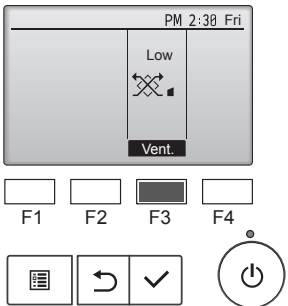

Press the [F3] button to go through the ventilation setting options in the order of "Off", "Low", and "High".  
\* Settable only when LOSSNAY unit is connected.

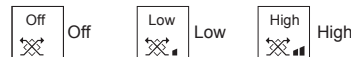

• The fan on some models of indoor units may be interlocked with certain models of ventilation units.

<Returning to the Main menu>

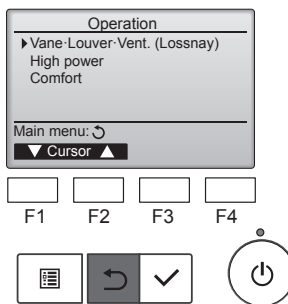

Press the [RETURN] button to go back to the Operation menu.

Notes:

- During swing operation, the directional indication on the screen does not change in sync with the directional vanes on the unit.
- Available directions depend on the type of unit connected.
- In the following cases, the actual air direction will differ from the direction indicated on the remote controller display.
  1. While the display is in "STAND BY" or "DEFROST" states.
  2. Immediately after starting heat mode (while the system is waiting for the mode change to take effect).
  3. In heat mode, when room temperature is higher than the temperature setting.

< How to set the fixed up/down air direction >

Notes:

- This function cannot be set depending on the outdoor unit to be connected.
- For SLZ-M-FA-A series, only the particular outlet can be fixed to certain direction with the procedures below. Once fixed, only the set outlet is fixed every time air conditioner is turned on. (Other outlets follow UP/DOWN air direction setting of remote controller.)
- **Explanation of word**
  - "Refrigerant address No." and "Unit No." are the numbers given to each air conditioner.
  - "Outlet No." is the number given to each outlet of air conditioner. (Refer to the illustration below.)
  - "Up/Down air direction" is the direction (angle) to fix.

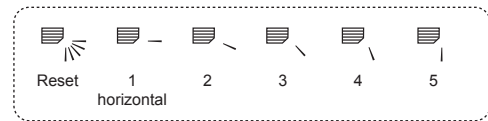

Remote controller setting

The airflow direction of this outlet is controlled by the airflow direction setting of remote controller.

Fixed

The airflow direction of this outlet is fixed in particular direction.  
\* When it is cold because of direct airflow, the airflow direction can be fixed horizontally to avoid direct airflow.

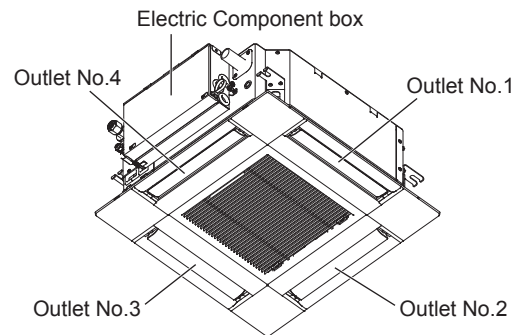

Note:

The outlet No. is indicated by the number of grooves on both ends of each air outlet. Set the air direction while checking the information shown on the remote controller display.

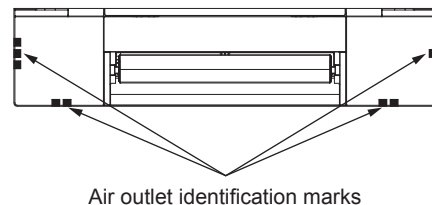

### 3. Operation

#### Manual vane angle (Wired remote controller)

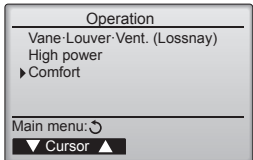

Select "Comfort" from the Operation menu, and press the [SELECT] button.

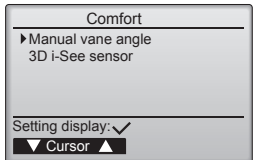

Select "Manual vane angle" with the [F1] or [F2] button, and press the [SELECT] button.

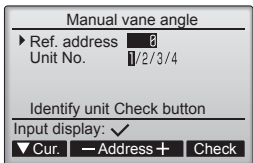

Move the cursor to "Ref. address" or "Unit No." with the [F1] button to select.

Select the refrigerant address and the unit number for the units to whose vanes are to be fixed, with the [F2] or [F3] button, and press the [SELECT] button.

- Ref. address: Refrigerant address
  - Unit No.: 1, 2, 3, 4
- Press the [F4] button to confirm the unit.

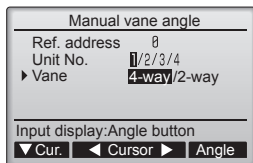

Select "Vane" with the [F1] button.

Select "4-way" or "2-way" with the [F2] or [F3] button, and press the [F4] button.

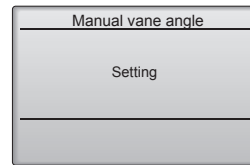
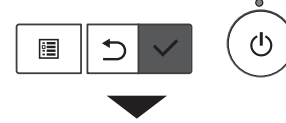
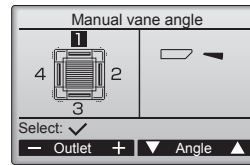

The current vane setting will appear.

Select the desired outlets from "1," "2," "3," "4," or "1, 2, 3, 4 (all outlets)" with the [F1] or [F2] button. Press the [F3] or [F4] button to go through the following options and select the desired setting.

#### \* Draft reduction

The airflow direction for this setting is more horizontal than the airflow direction for the "Step 1" setting in order to reduce a drafty feeling. The draft reduction can be set for only 1 vane.

#### Note:

**Do not set the draft reduction in an environment with high humidity. Otherwise, condensation may form and drip.**

#### Vane setting

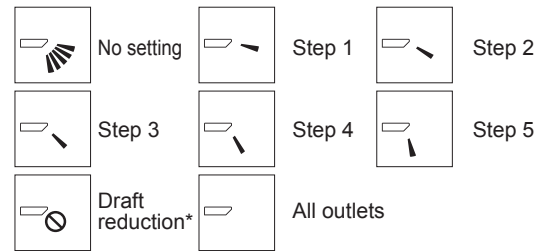

Press the [SELECT] button to save the settings.

A screen will appear that indicates the setting information is being transmitted.

The setting changes will be made to the selected outlet.

The screen will automatically return to the one shown above (step 5) when the transmission is completed.

Make the settings for other outlets, following the same procedures.

**If all outlets are selected,  will be displayed the next time the unit goes into operation.**

#### Navigating through the screens

- To return to the previous screen ..... [RETURN] button

### 3. Operation

#### Manual vane angle (Wired remote controller)

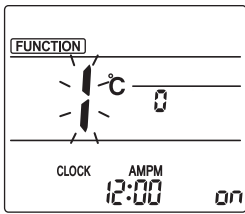

Fig. 1

- Going to the Manual vane setting mode  
Press the **MENU** button.  
(Start this operation from the status of remote controller display turned off.)  
"FUNCTION" is lighted and "1" blinks. (Fig. 1)  
Press the **▲** button to select "2", and then press the **SET** button.

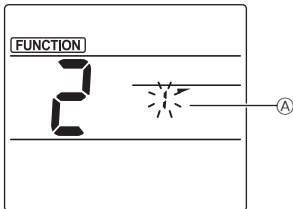

Fig. 2

- Selecting the vane number (Fig. 2)  
Press the **▼** buttons to select the vane number **Ⓐ**, and then press the **SET** button.

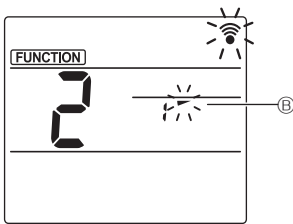

Fig. 3

- Setting the vane angle (Fig. 3)  
Press the **▼** buttons to select the vane angle **Ⓑ**.  
Point the wireless remote controller toward the receiver on the indoor unit, and then press the **SET** button.

Display	✓	✓	✓	✓
Setting	Step 1	Step 2	Step 3	Step 4
Display	1	2	No display	
Setting	Step 5	No setting	Draft reduction*	

\* The draft reduction can be set for only 1 vane.  
The setting is enabled only for the last vane that was set.

#### Confirmation procedure (wired remote controller)

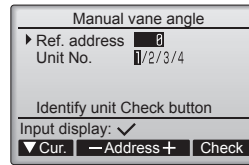

- First, confirm by setting "Ref address" to 0 and "Unit No." to 1.

  - Move the cursor to "Ref. address" or "Unit No." with the [F1] button to select.
  - Select the refrigerant address and the unit number for the units to whose vanes are to be fixed, with the [F2] or [F3] button, and press the [SELECT] button.
  - Ref. address: Refrigerant address
  - Unit No.: 1, 2, 3, 4

Press the [F4] button to confirm the unit.

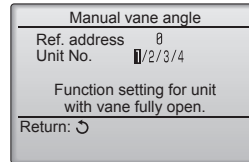

- Change the "Unit No." in order and check each unit.

  - Press the [F1] button to select "Unit No.".
  - Press the [F2] or [F3] button to change the "Unit No." to the unit that you want to check, and then press the [F4] button.
  - After pressing the [F4] button, wait approximately 15 seconds, and then check the current state of the air conditioner.
    - The vane is pointing downward. → This air conditioner is displayed on the remote controller.
    - All outlets are closed. → Press the [RETURN] button and continue the operation from the beginning.
    - The messages shown to the left are displayed. → The target device does not exist at this refrigerant address.
  - Press the [RETURN] button to return to the initial screen.

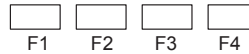
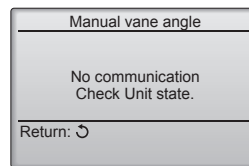

- Change the "Ref. address" to the next number.

  - Refer to step ① to change the "Ref. address" and continue with the confirmation.

### 3. Operation

#### 3.6. 3D i-see Sensor setting

**Note:**  
This function cannot be set depending on the outdoor unit to be connected.

##### 3.6.1 3D i-see Sensor setting

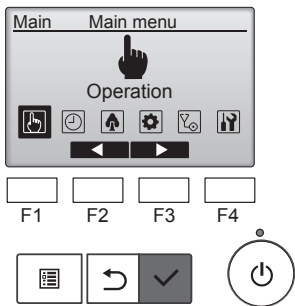

① Select "Operation" from the Main menu, and press the [SELECT] button.

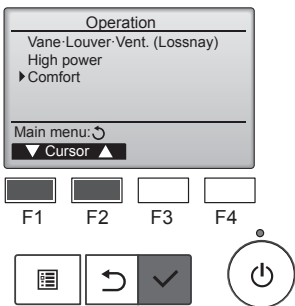

② Select "Comfort" from the Operation menu, and press the [SELECT] button.

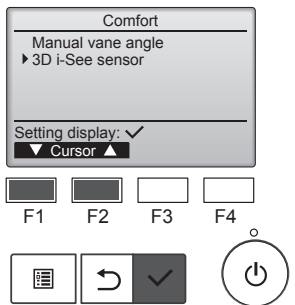

③ Select "3D i-See sensor" with the [F1] or [F2] button, and press the [SELECT] button.

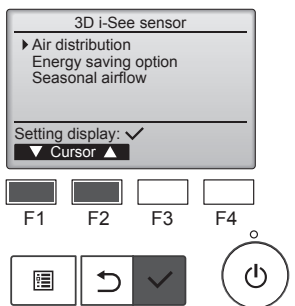

④ Select the desired menu with the [F1] or [F2] button, and press the [SELECT] button.

- Air distribution  
Select the airflow direction control method when the airflow direction is set to "Auto".
- Energy saving option  
Operates the energy-save mode according to whether persons are detected in the room by the 3D i-see Sensor.
- Seasonal airflow  
When the thermostat turns off, the fan and the vanes operate according to the control settings.

##### 3.6.2 Air distribution

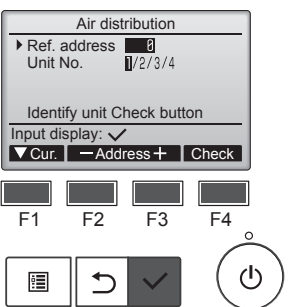

① Move the cursor to "Ref. address" or "Unit No." with the [F1] button to select.

Select the refrigerant address and the unit number for the units to whose vanes are to be fixed, with the [F2] or [F3] button, and press the [SELECT] button.

- Ref. address: Refrigerant address
- Unit No.: 1, 2, 3, 4  
Press the [F4] button to confirm the unit.  
The vane of only the target indoor unit is pointing downward.

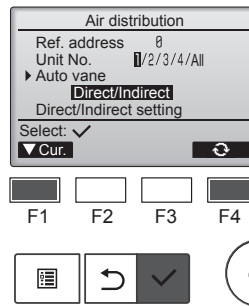

② Select the menu with the [F4] button.  
Default → Area → Direct/Indirect → Default...

Default: The vanes move the same as during normal operation.

"Area"\*: The vanes move to the down airflow direction toward areas with a high floor temperature during cooling mode and toward areas with a low floor temperature during heating mode. Otherwise, the vanes move to the horizontal airflow direction.

"Direct/Indirect"\*: The vanes automatically move relative to the areas where persons are detected.  
The vanes operate as indicated in the following table.

\* In order to enable this function, the airflow direction must be set to "Auto".

	Vane setting	
	Direct	Indirect
Cooling	horizontal → swing	keep horizontal
Heating	keep downward	downward → horizontal

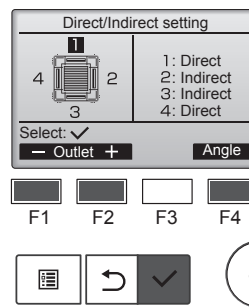

③ When Direct/Indirect is selected, set each air outlet.  
Select the air outlet with the [F1] or [F2] button, and change the setting with the [F4] button.  
After changing the settings for all of the air outlets, press the [SELECT] button to save the settings.

##### ■ i-see button (Wireless remote controller)



① Each time the [i-see] button is pressed during operation, the setting changes in the following order: OFF → Direct → Indirect.

Display			
Setting	OFF	Direct	Indirect

When the setting is changed from OFF to Direct or Indirect, the vane setting changes to "Auto". This setting is applied collectively to all of the vanes.

# 3. Operation

## 3.6.3 Energy saving option

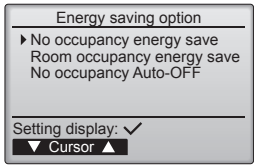

① Select the desired menu with the [F1] or [F2] button.

**No occupancy energy save**  
If there are no persons in the room for 60 minutes or more, energy-saving operation equal to 2 °C is performed.

**Room occupancy energy save**  
If the occupancy rate decreases to approximately 30% of the maximum occupancy rate, energy-saving operation equal to 1 °C is performed.

**No occupancy Auto-OFF**  
If there are no persons in the room for the set amount of time (60–180 minutes), the operation is automatically stopped.

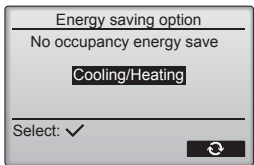

② When No occupancy energy save or Room occupancy energy save is selected

Select the setting with the [F4] button.

OFF → Cooling only → Heating only → Cooling/Heating → OFF...

After changing the setting, press the [SELECT] button to save the setting.

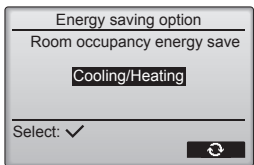

**OFF:** The function is disabled.  
**Cooling only:** The function is enabled only during cooling mode.  
**Heating only:** The function is enabled only during heating mode.  
**Cooling/Heating:** The function is enabled during both cooling mode and heating mode.

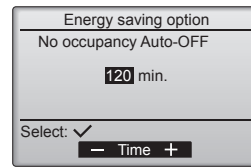

③ When No occupancy Auto-OFF is selected  
Set the time with the [F3] or [F4] button.

---: The setting is disabled (the operation will not stop automatically).  
60–180: The time can be set in 10-minute increments.

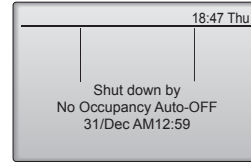

④ The message at left will appear if the operation was stopped automatically by the No occupancy Auto-OFF setting.

## 3. Operation

### 3.6.4 Seasonal airflow function

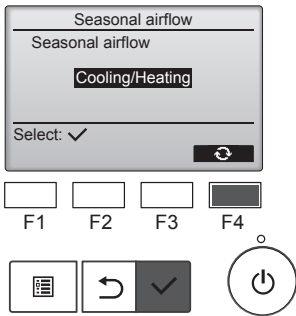

- Select the setting with the [F4] button.  
OFF → Cooling only → Heating only → Cooling/Heating → OFF...

After changing the setting, press the [SELECT] button to save the setting.

OFF: The function is disabled.  
Cooling only: When the thermostat turns off during cooling mode, the vanes move up and down.

Heating only: When the thermostat turns off during heating mode, the vanes move to the horizontal airflow direction to circulate the air.

Cooling/Heating: The function is enabled during both cooling mode and heating mode.

- \* In order to enable this function, the airflow direction must be set to "Auto".

#### Notes:

Any person at the following places cannot be detected.

- Along the wall on which the air conditioner is installed
- Directly under the air conditioner
- Where any obstacle, such as furniture, is between the person and the air conditioner

A person may not be detected in the following situations.

- Room temperature is high.
  - A person wears heavy clothes and his/her skin is not exposed.
  - A heating element of which temperature changes significantly is present.
  - Some heat sources, such as a small child or pet, may not be sensed.
  - A heat source does not move for a long time.
- The 3D i-see Sensor operates once approximately every 3 minutes to measure the floor temperature and detect persons in the room.
- The intermittent operating sound is a normal sound produced when the 3D i-see Sensor is moving.

### 3.7. Ventilation

For LOSSNAY combination

- The following 2 patterns of operation is available.
  - Run the ventilator together with indoor unit.
  - Run the ventilator independently.

#### Notes: (for wireless remote controller)

- Running the ventilator independently is not available.
- No indication on the remote controller.

## 4. Timer

- Timer functions are different by each remote controller.
- For details on how to operate the remote controller, refer to the appropriate operation manual included with each remote controller.

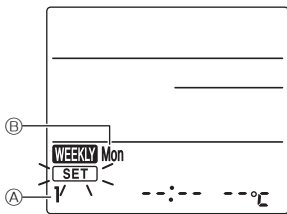

Fig. 1



Fig. 2



Fig. 3



Fig. 4

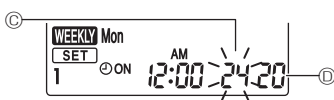

Fig. 5

#### Weekly schedule (Wireless remote controller)

- The weekly schedule can be set to four operation patterns for each day of the week. The settings include the on and off times and the set temperature.

#### <Editing mode>

- Switching to the editing mode

- Press the [EDIT] button when the unit is operating or stopped.  
[SET] blinks. (Fig. 1)

- Selecting the setting pattern

- Press the [1~4] button to select the setting pattern number.

Each time the [1~4] button is pressed, the pattern number ① changes in the following order: 1 → 2 → 3 → 4.

- Selecting the day of the week

- Press the [DAY] button to select the day of the week to set.

Each time the [DAY] button is pressed, the day of the week ② changes in the following order: Mon → Tue → Wed → Thu → Fri → Sat → Sun → All days.

- Selecting the operation settings

- Push the [ON/OFF] button to select the operation on or off setting. (Fig. 2)

⊙ON (⊙OFF) is lighted.

Each time the [ON/OFF] button is pressed, the setting changes in the following order: ⊙ON → ⊙OFF.

- Press the [TIME] button to select the operation time. (Fig. 3)

The operation time blinks.

Set the operation time using the [↑] [↓] buttons.

- The operation time can be set in 10-minute increments.

- Push the [TEMP] button to select the set temperature. (Fig. 4)

The set temperature blinks.

Set the temperature using the [↑] [↓] buttons.

- When setting the off operation, the temperature cannot be set.

When the AUTO (dual set point) mode is enabled, press the [TEMP] button to switch between the upper limit ③ and the lower limit ④. (Fig. 5)

- By pressing the [DELETE] button, the pattern number settings for the displayed day of the week are deleted.

- Repeat steps 2~4 to select the settings for each day of the week.

#### <Transmitting the settings>

Point the transmission area of the wireless remote controller towards the receiver on the indoor unit and operate the controller. Confirm that the indoor unit beeps 7 times.

Press the [SET] button.

#### <Enabling the weekly schedule>

Press the [ON/OFF] button.

The weekly schedule operates when [WEEKLY] is on.

- The weekly schedule does not function when the On/Off timer is enabled.

The weekly schedule operates when all of the On/Off timer settings have been executed.



## 5. Care and Cleaning

### ■ Filter information

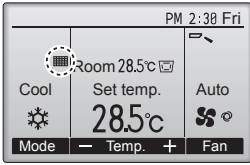

 will appear on the Main display in the Full mode when it is time to clean the filters.

**Wash, clean, or replace the filters when this sign appears. Refer to the indoor unit Instructions Manual for details.**

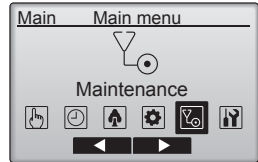

Select "Maintenance" from the Main menu, and press the [SELECT] button.

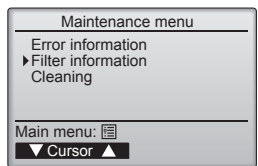

Select "Filter information" from the Maintenance menu, and press the [SELECT] button.

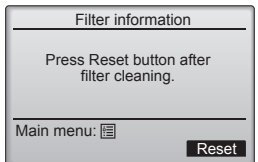
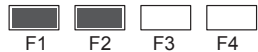

Press the [F4] button to reset filter sign. Refer to the indoor unit Instructions Manual for how to clean the filter.

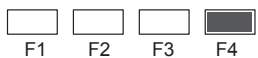

Select "OK" with the [F4] button.

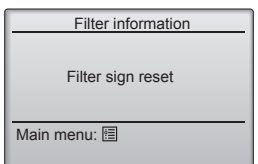
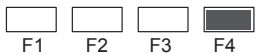

A confirmation screen will appear.

Navigating through the screens

- To go back to the Main menu ..... [MENU] button
- To return to the previous screen ..... [RETURN] button

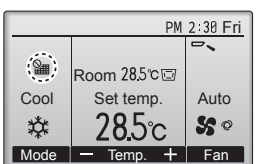

When the  is displayed on the Main display in the Full mode, the system is centrally controlled and the filter sign cannot be reset.

If two or more indoor units are connected, filter cleaning timing for each unit may be different, depending on the filter type.

The icon  will appear when the filter on the main unit is due for cleaning.

When the filter sign is reset, the cumulative operation time of all units will be reset.

The icon  is scheduled to appear after a certain duration of operation, based on the premise that the indoor units are installed in a space with ordinary air quality. Depending on the air quality, the filter may require more frequent cleaning.

The cumulative time at which filter needs cleaning depends on the model.

- This indication is not available for wireless remote controller.

#### ⚠ Caution:

- Ask authorized people to clean the filter.

#### ► Cleaning the filters

- Clean the filters using a vacuum cleaner. If you do not have a vacuum cleaner, tap the filters against a solid object to knock off dirt and dust.
- If the filters are especially dirty, wash them in lukewarm water. Take care to rinse off any detergent thoroughly and allow the filters to dry completely before putting them back into the unit.

#### ⚠ Caution:

- Do not dry the filters in direct sunlight or by using a heat source, such as an electric heater: this may warp them.
- Do not wash the filters in hot water (above 50°C), as this may warp them.
- Make sure that the air filters are always installed. Operating the unit without air filters can cause malfunction.

#### ⚠ Caution:

- Before you start cleaning, stop operation and turn OFF the power supply.
- Indoor units are equipped with filters to remove the dust of sucked-in air. Clean the filters using the methods shown in the following sketches.

#### ► Filter removal

#### ⚠ Caution:

- In removing the filter, precautions must be taken to protect your eyes from dust. Also, if you have to climb up on a stool to do the job, be careful not to fall.
- When the filter is removed, do not touch the metallic parts inside the indoor unit, otherwise injury may result.

#### ■ SLZ-M-FA-A

- ① Slide the levers on the intake grille in the direction indicated by the arrow and it should open.
  - ② Open the intake grille.
  - ③ Release the knob on the center edge of the intake grille and pull the filter forward to remove the filter.
- Ⓐ Intake grille levers Ⓑ Grille Ⓒ Intake grille Ⓓ Filter

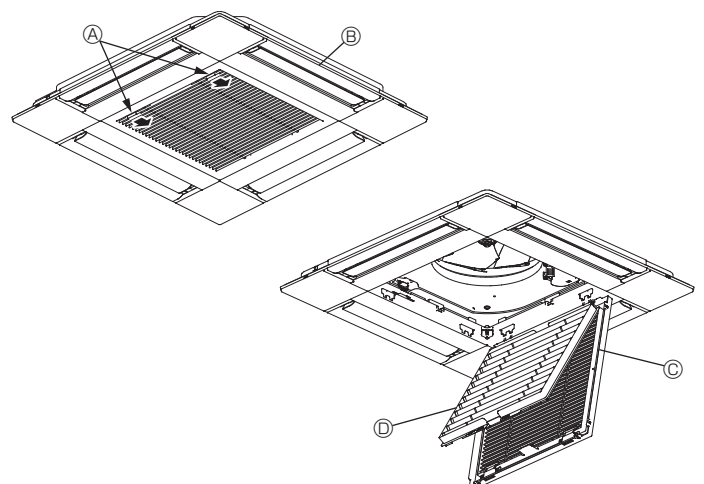



## 6. Emergency Operation for Wireless Remote-controller

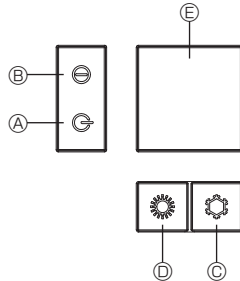
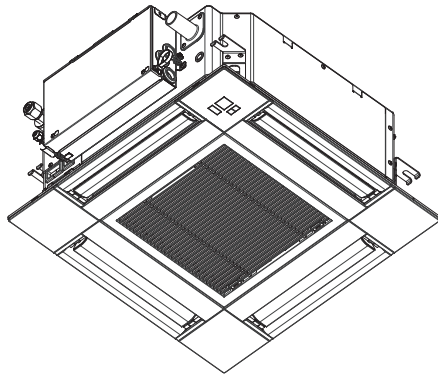

### When the remote controller cannot be used

When the batteries of the remote controller run out or the remote controller malfunctions, the emergency operation can be done using the emergency buttons on the grille.

- Ⓐ DEFROST/STAND BY lamp
- Ⓑ Operation lamp
- Ⓒ Emergency operation cooling switch
- Ⓓ Emergency operation heating switch
- Ⓔ Receiver

### Starting operation

- To operate the cooling mode, press the button Ⓒ for more than 2 seconds.
- To operate the heating mode, press the button Ⓓ for more than 2 seconds.
- Lighting of the Operation lamp Ⓑ means the start of operation.

### Notes:

- Details of emergency mode are as shown below.
- Details of EMERGENCY MODE are as shown below.

Operation mode	COOL	HEAT
Set temperature	24°C	24°C
Fan speed	High	High
Airflow direction	Horizontal	Downward 4 (5)

### Stopping operation

- To stop operation, press the button Ⓒ or the button Ⓓ for more than 2 seconds.

## 7. Trouble Shooting

Having trouble?	Here is the solution. (Unit is operating normally.)
Air conditioner does not heat or cool well.	<ul style="list-style-type: none"> <li>■ Clean the filter. (Airflow is reduced when the filter is dirty or clogged.)</li> <li>■ Check the temperature adjustment and adjust the set temperature.</li> <li>■ Make sure that there is plenty of space around the outdoor unit. Is the indoor unit air intake or outlet blocked?</li> <li>■ Has a door or window been left open?</li> </ul>
When heating operation starts, warm air does not blow from the indoor unit soon.	<ul style="list-style-type: none"> <li>■ Warm air does not blow until the indoor unit has sufficiently warmed up.</li> </ul>
During heating mode, the air conditioner stops before the set room temperature is reached.	<ul style="list-style-type: none"> <li>■ When the outdoor temperature is low and the humidity is high, frost may form on the outdoor unit. If this occurs, the outdoor unit performs a defrosting operation. Normal operation should begin after approximately 10 minutes.</li> </ul>
During cooling mode, the air conditioner stops when the set room temperature is reached.	<ul style="list-style-type: none"> <li>■ For SLZ-M-FA-A series, when the set room temperature is reached during cooling mode, the fan operates at the lowest speed.</li> </ul>
Airflow direction changes during operation or airflow direction cannot be set.	<ul style="list-style-type: none"> <li>■ During heating mode, the vanes automatically move to the horizontal airflow direction when the airflow temperature is low or during defrosting mode.</li> </ul>
When the airflow direction is changed, the vanes always move up and down past the set position before finally stopping at the position.	<ul style="list-style-type: none"> <li>■ When the airflow direction is changed, the vanes move to the set position after detecting the base position.</li> </ul>
A flowing water sound or occasional hissing sound is heard.	<ul style="list-style-type: none"> <li>■ These sounds can be heard when refrigerant is flowing in the air conditioner or when the refrigerant flow is changing.</li> </ul>
A cracking or creaking sound is heard.	<ul style="list-style-type: none"> <li>■ These sounds can be heard when parts rub against each other due to expansion and contraction from temperature changes.</li> </ul>
The room has an unpleasant odor.	<ul style="list-style-type: none"> <li>■ The indoor unit draws in air that contains gases produced from the walls, carpeting, and furniture as well as odors trapped in clothing, and then blows this air back into the room.</li> </ul>
A white mist or vapor is emitted from the indoor unit.	<ul style="list-style-type: none"> <li>■ If the indoor temperature and the humidity are high, this condition may occur when operation starts.</li> <li>■ During defrosting mode, cool airflow may blow down and appear like a mist.</li> </ul>
Water or vapor is emitted from the outdoor unit.	<ul style="list-style-type: none"> <li>■ During cooling mode, water may form and drip from the cool pipes and joints.</li> <li>■ During heating mode, water may form and drip from the heat exchanger.</li> <li>■ During defrosting mode, water on the heat exchanger evaporates and water vapor may be emitted.</li> </ul>
"" appears in the remote controller display.	<ul style="list-style-type: none"> <li>■ During central control, "" appears in the remote controller display and air conditioner operation cannot be started or stopped using the remote controller.</li> </ul>
When restarting the air conditioner soon after stopping it, it does not operate even though the ON/OFF button is pressed.	<ul style="list-style-type: none"> <li>■ Wait approximately three minutes. (Operation has stopped to protect the air conditioner.)</li> </ul>

## 7. Trouble Shooting

Having trouble?	Here is the solution. (Unit is operating normally.)												
Air conditioner operates without the ON/OFF button being pressed.	<ul style="list-style-type: none"> <li>■ Is the on timer set? Press the ON/OFF button to stop operation.</li> <li>■ Is the air conditioner connected to a central remote controller? Consult the concerned people who control the air conditioner.</li> <li>■ Does "S" appear in the remote controller display? Consult the concerned people who control the air conditioner.</li> <li>■ Has the auto recovery feature from power failures been set? Press the ON/OFF button to stop operation.</li> </ul>												
Air conditioner stops without the ON/OFF button being pressed.	<ul style="list-style-type: none"> <li>■ Is the off timer set? Press the ON/OFF button to restart operation.</li> <li>■ Is the air conditioner connected to a central remote controller? Consult the concerned people who control the air conditioner.</li> <li>■ Does "S" appear in the remote controller display? Consult the concerned people who control the air conditioner.</li> </ul>												
Remote controller timer operation cannot be set.	<ul style="list-style-type: none"> <li>■ Are timer settings invalid? If the timer can be set, "E" or "D" appears in the remote controller display.</li> </ul>												
"PLEASE WAIT" appears in the remote controller display.	<ul style="list-style-type: none"> <li>■ The initial settings are being performed. Wait approximately 3 minutes.</li> </ul>												
An error code appears in the remote controller display.	<ul style="list-style-type: none"> <li>■ The protection devices have operated to protect the air conditioner.</li> <li>■ Do not attempt to repair this equipment by yourself. Turn off the power switch immediately and consult your dealer. Be sure to provide the dealer with the model name and information that appeared in the remote controller display.</li> </ul>												
Draining water or motor rotation sound is heard.	<ul style="list-style-type: none"> <li>■ When cooling operation stops, the drain pump operates and then stops. Wait approximately 3 minutes.</li> </ul>												
The vanes do not move or the indoor unit does not respond to input from the wireless remote controller.	<ul style="list-style-type: none"> <li>■ The junction wire connectors of the vane motor and signal receiver may not be connected correctly. Have an installer check the connections. (The colors of the male and female sections of the junction wire connectors must match.)</li> </ul>												
Noise is louder than specifications.	<ul style="list-style-type: none"> <li>■ The indoor operation sound level is affected by the acoustics of the particular room as shown in the following table and will be higher than the noise specification, which was measured in an echo-free room.</li> </ul> <table border="1" style="margin-left: auto; margin-right: auto;"> <thead> <tr> <th></th> <th>High sound-absorbing rooms</th> <th>Normal rooms</th> <th>Low sound-absorbing rooms</th> </tr> </thead> <tbody> <tr> <td>Location examples</td> <td>Broadcasting studio, music room, etc.</td> <td>Reception room, hotel lobby, etc.</td> <td>Office, hotel room</td> </tr> <tr> <td>Noise levels</td> <td>3 to 7 dB</td> <td>6 to 10 dB</td> <td>9 to 13 dB</td> </tr> </tbody> </table>		High sound-absorbing rooms	Normal rooms	Low sound-absorbing rooms	Location examples	Broadcasting studio, music room, etc.	Reception room, hotel lobby, etc.	Office, hotel room	Noise levels	3 to 7 dB	6 to 10 dB	9 to 13 dB
	High sound-absorbing rooms	Normal rooms	Low sound-absorbing rooms										
Location examples	Broadcasting studio, music room, etc.	Reception room, hotel lobby, etc.	Office, hotel room										
Noise levels	3 to 7 dB	6 to 10 dB	9 to 13 dB										
Nothing appears in the wireless remote controller display, the display is faint, or signals are not received by the indoor unit unless the remote controller is close.	<ul style="list-style-type: none"> <li>■ The batteries are low. Replace the batteries and press the Reset button.</li> <li>■ If nothing appears even after the batteries are replaced, make sure that the batteries are installed in the correct directions (+, -).</li> </ul>												
The operation lamp near the receiver for the wireless remote controller on the indoor unit is flashing.	<ul style="list-style-type: none"> <li>■ The self diagnosis function has operated to protect the air conditioner.</li> <li>■ Do not attempt to repair this equipment by yourself. Turn off the power switch immediately and consult your dealer. Be sure to provide the dealer with the model name.</li> </ul>												
The wireless remote controller does not operate (the indoor unit beeps 4 times).	<ul style="list-style-type: none"> <li>■ Switch the auto mode setting to the AUTO (single set point) mode or AUTO (dual set point) mode. For details, refer to the included Notice (A5 sheet) or the Installation Manual.</li> </ul>												

## 8. Installation, relocation and inspection

### Installation place

Avoid installing the air conditioner in the following places.

- Where flammable gas could leak.

### ⚠ Caution:

**Do not install the unit where flammable gas could leak. If gas leaks and collects around the unit, it may cause an explosion.**

- Where there is much machine oil.
- Salty place such as the seaside.
- Where sulfide gas is generated such as a hot spring.
- Where there is oil splashing or much oily smoke.

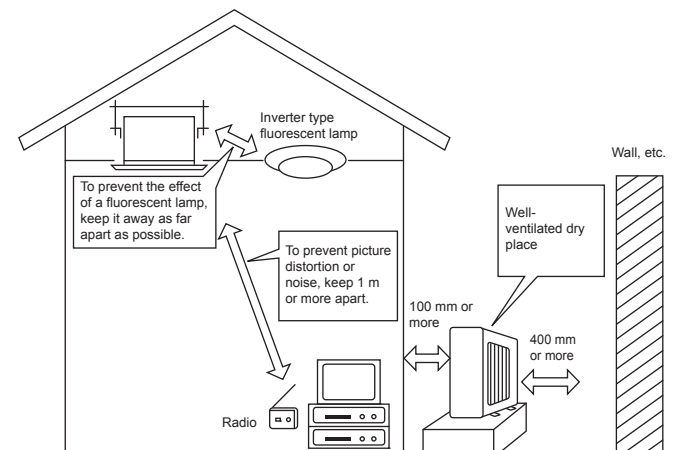

## 8. Installation, relocation and inspection

### ⚠ Warning:

If the air conditioner operates but does not cool or heat (depending on model) the room, consult your dealer since there may be a refrigerant leak. Be sure to ask the service representative whether there is refrigerant leakage or not when repairs are carried out.

The refrigerant charged in the air conditioner is safe. Refrigerant normally does not leak, however, if refrigerant gas leaks indoors, and comes into contact with the fire of a fan heater, space heater, stove, etc., harmful substances will be generated.

### Electrical work

- Provide an exclusive circuit for power supply of the air conditioner.
- Be sure to observe the breaker capacity.

### ⚠ Warning:

• The customer should not install this unit. If the unit is installed incorrectly, fire, electric shock, injury due to a falling unit, water leakage, etc. may result.

• Do not connect using branched outlet or an extension cord, and do not attach many loads to one electric outlet.

A fire or electric shock may result from poor contact, poor insulation, exceeding the permissible current, etc.

Consult your dealer.

### ⚠ Caution:

#### • Apply grounding

Do not connect a grounding wire to a gas pipe, water pipe, lightning rod or ground wire of a telephone.

If a grounding is incorrect, it may cause an electric shock.

• Install an earth leakage breaker depending on the place where the air conditioner is to be installed (humid place, etc.).

If the earth leakage breaker is not installed, it may cause an electric shock.

### Inspection and maintenance

- When the air conditioner is used for several seasons, the capacity may be lowered due to dirt inside the unit.
- Depending upon the conditions of use, an odor may be generated or dirt, dust, etc. may prevent proper drainage.
- It is recommended to apply inspection and maintenance (charged) by a specialist in addition to normal maintenance. Consult your dealer.

### Also consider operation sound

- Do not put an object around the air outlet of the outdoor unit. It may cause lowering of capacity or increase operating sound.
- If abnormal sound is heard during operation, consult your dealer.

### Relocation

- When the air conditioner is to be removed or reinstalled because of rebuilding, moving, etc., special techniques and work are required.

### ⚠ Warning:

Repair or relocation should not be done by the customer.

If this is done incorrectly, it may cause a fire, electric shock, injury by dropping of the unit, water leakage, etc. Consult your dealer.

### Disposal

- To dispose of this product, consult your dealer.

If you have any question, consult your dealer.

## 9. Specifications

Model	SLZ-M25FA-A	SLZ-M35FA-A	SLZ-M50FA-A	SLZ-M60FA-A
Power Supply (Voltage <V>, Frequency <Hz>)	~N, 230V, 50Hz			
Rated Input (Indoor only) <kW>	0.02	0.03	0.03	0.04
Rated Current (Indoor only) <A>	0.20	0.32	0.32	0.43
Dimension (Height) <mm>	245 (10)			
Dimension (Width) <mm>	570 (625)			
Dimension (Depth) <mm>	570 (625)			
Fan airflow rate (Low-Middle-High) <m <sup>3</sup> /min>	6.5 - 7.5 - 8.5	6.5 - 9.0 - 11.5	7.0 - 9.0 - 11.5	7.5 - 11.5 - 13.0
Noise level (Low-Middle-High) <dB>	25 - 28 - 31	25 - 33 - 39	27 - 34 - 39	32 - 40 - 43
Net weight <kg>	15 (3)			

Notes: 1. This figure ( ) indicates GRILLE's.

2. Specifications subject to change without notice.

### Guaranteed operating range

		Indoor	Outdoor
Cooling	Upper limit	32°C DB, 23°C WB	46°C DB, - / 52°C DB, - *1
	Lower limit	21°C DB, 15°C WB	-10°C DB, - / -15°C DB, - *1
Heating	Upper limit	27°C DB, -	24°C DB, 18°C WB
	Lower limit	20°C DB, -	-10°C DB, -11°C WB

\*1 Depend on outdoor unit.

Units should be installed by licensed electric contractor accordingly to local code requirement.

This product is designed and intended for use in the residential,  
commercial and light-industrial environment.

Please be sure to put the contact address/telephone number on  
this manual before handing it to the customer.



**MITSUBISHI ELECTRIC CORPORATION**

HEAD OFFICE: TOKYO BUILDING, 2-7-3, MARUNOUCHI, CHIYODA-KU, TOKYO 100-8310, JAPAN